

OPTIKA[®]
M I C R O S C O P E S
I T A L Y





























LABORATORY Microscopes

LABORATORY Microscopes

B-290 SERIES - Entry-Level Lab Upright Microscopes	page 81
B-380 SERIES - Middle-Level Routine Lab Upright Microscopes	page 97
B-510 SERIES - Advanced Routine Lab Upright Microscopes	page 121
B-810/B-1000 SERIES - Research Lab Upright Microscopes	page 147
IM-3 SERIES - Routine Lab Inverted Microscopes	page 193
IM-5 SERIES - Routine & Research Lab Inverted Microscopes	page 211
IM-7 MODEL - Inverted Research Microscope	page 231
POL SERIES - Routine & Research Lab Polarizing Microscopes	page 243
FLUO SERIES - Routine & Research Lab Fluorescence Microscopes	page 253
SZR-180 MODEL - Research Stereomicroscope	page 275

Icons

	Field number		W-Plan objectives (up to 22mm f.o.v)		Tablet screen size
	Incident light		U-Plan objectives (up to 24mm f.o.v)		Camera resolution
	Transmitted light		Oil/Water 100x objective		Software included
	LED illuminator		Fluorescence		HDMI output
	X-LED illuminator		Metallography		MicroSD slot
	Automatic light control		Polarized light		Wi-Fi
	Multi-Plug low voltage power supply		Darkfield		BlueTooth
	Infinity corrected optics		Phase contrast		IVD Available *
	N-Plan objectives (up to 20mm f.o.v)		USB connection		Antibacteria treatment available

* The IVD code must be requested at order

OPTIKA[®]
M I C R O S C O P E S
I T A L Y

B-290 Series



Entry-Level Lab Upright Microscopes

Best Value-for-Money Solutions & Versatile Use

SUITABLE FOR UNIVERSITIES, EXPERTS & ROUTINE LABS

- » The ideal choice for common lab requirements
- » Simply engineered for life-science
- » Ready for phase contrast and darkfield

EXCELLENT PRICE/PERFORMANCE RATIO

- » N-PLAN objectives (160 mm or IOS) for flat images on 20 mm FN
- » Fixed Koehler illumination for crisp and contrasted images
- » Rounded edge, rackless stage to prevent scratches



B-290TB - BREAK NEW GROUND WITH WINDOWS TABLET

- » Large touch-screen of 10.1" with fast, responsive and smooth control
- » 360° rotatable, tiltable and easily detachable
- » Simultaneous camera & power connection for long-term operation

B-290LD SERIES - ON-FIELD TBC & MALARIA DIAGNOSIS

- » Ultra-convenient LED fluorescence, blue filter
- » No waiting time, immediate operation
- » Cost-effective, money-saving technology

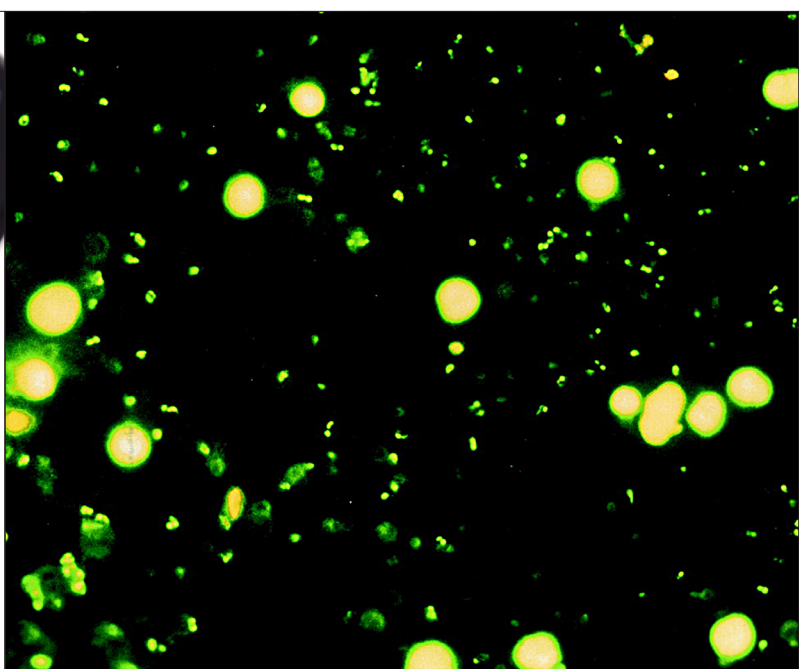
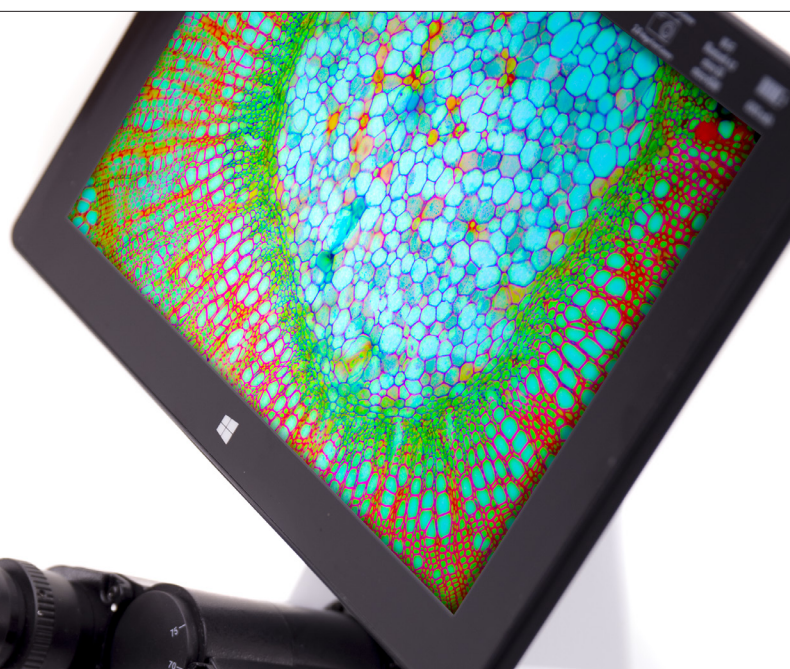

100x Oil/Water Objective – Only at OPTIKA

2

SAME OBJECTIVE FOR OIL AND WATER USE

- » Oil represents the best media for high numerical aperture
- » Water combines results with convenience
- » Water is recommended especially for educational purposes

UNPARALLELED TIME & MONEY SAVING

- » Save time by forgetting about tedious cleaning
- » No time-wasting procedures for maintenance
- » No additional expenses due to inappropriate cleaning

Laboratory

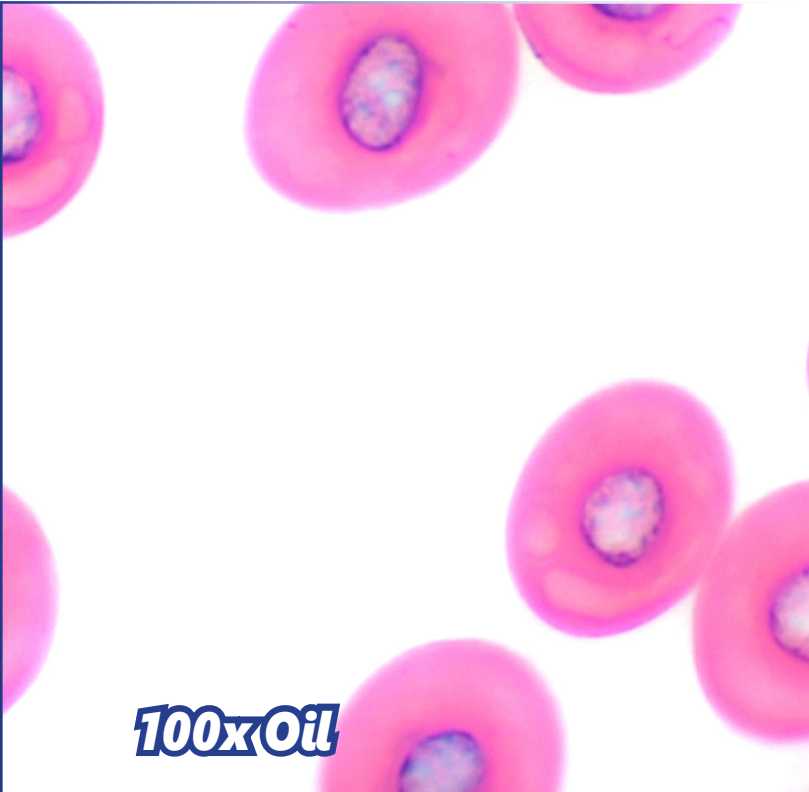

100x Oil

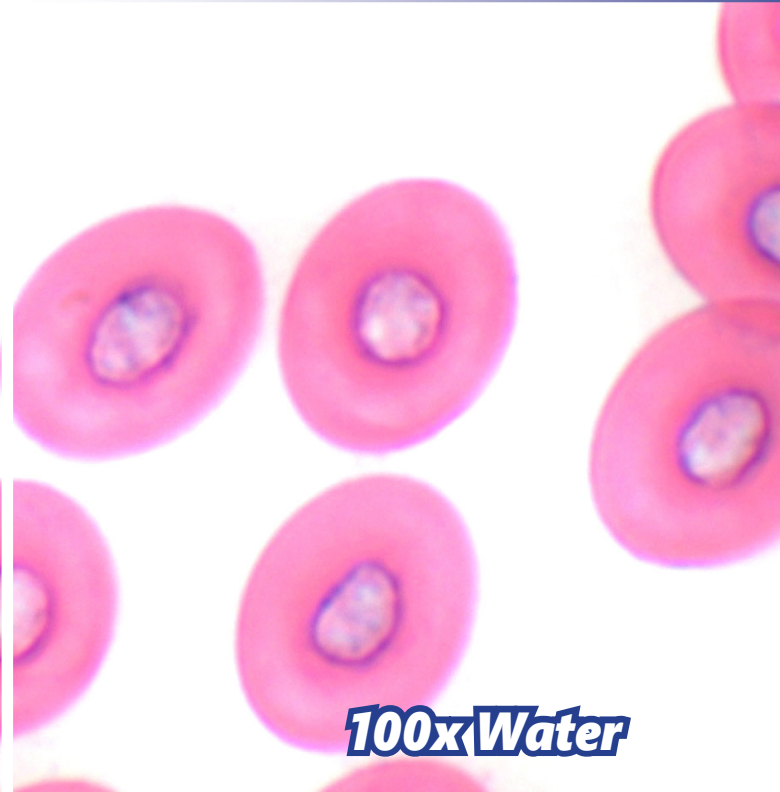

100x Water

X-LED³ – Only Available at OPTIKA

STATE-OF-THE-ART ILLUMINATION SYSTEM

- » Uncomparable light intensity, exclusive lens & collector design
- » Constant pure-white colour temperature at all intensity levels
- » Unmatched color fidelity, uniformity and brightness

CUT ELECTRICITY BILLS BY 90%

- » Money & energy saving, only 3.6 W
- » More efficient brightness than a 50 W halogen lamp
- » LED long lifetime (65,000 hours = 22 years at 8 hours/day usage)

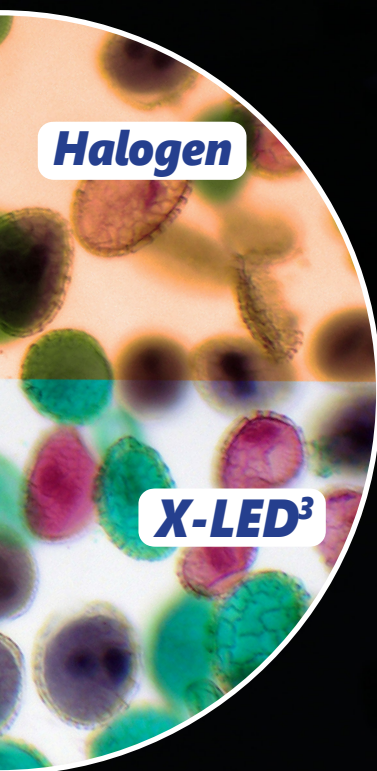
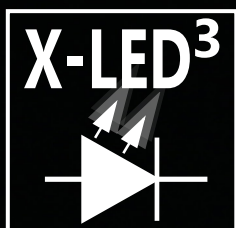

Halogen

X-LED³



Multi-plug power supply



IOS & Professional Features

2

LABORATORY GRADE OPTICS FOR OUTSTANDING IMAGES

- » Planachromatic optics
- » Designed to ensure field flatness on 20 mm (N-PLAN)
- » IOS Infinity corrected optical system

FULL CONTROL OF YOUR IMAGES

- » Fully settable condenser for perfect imaging
- » Easy to set objective-coded iris diaphragm, focusable & centrabable
- » Phase contrast and darkfield slider available

Laboratory



B-290 Series

This series incorporates all the experience gathered by OPTIKA Microscopes in the field of light microscopy, adapted specifically for common laboratory applications. Suitable for routine microscopy with brightfield, darkfield, phase contrast and LED fluorescence, designed to last.

X-LED³ Exclusive Lighting Source

Special technology able to double the light intensity for incomparable performance, ensuring constant pure-white colour temperature (6,300K colour temperature). Relevant money and energy saving thanks to the incredibly low energy consumptions which allows you to cut the electricity bills by 90%!
The electric consumption (3.6 W only) proves the high efficiency of this system: incredibly high light intensity combined with low consumption.

Safe And Convenient Operations

Rounded edge rackless stage has been designed with a belt-driven mechanism that allows a smooth movement without any protruding part.
This design gives you a more compact solution and lowers any risk of injury after accidentally hitting the rack with your hands.

Clear Observation With 100x Objective

Students and basic users will enjoy B-290 Series for the clear and sharp images they can get using 100x objective with water, thanks to the extremely bright X-LED³ light source and the fully centerable Abbe condenser. Forget about the tedious lens cleaning you are used to when using 100x objective: dirt and dust will not affect your objective.

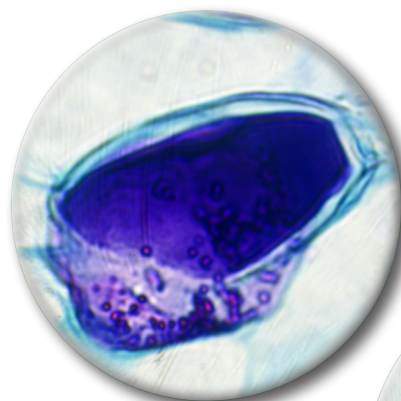

100x DRY

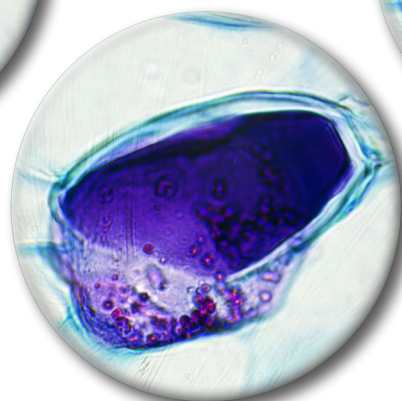

100x WATER

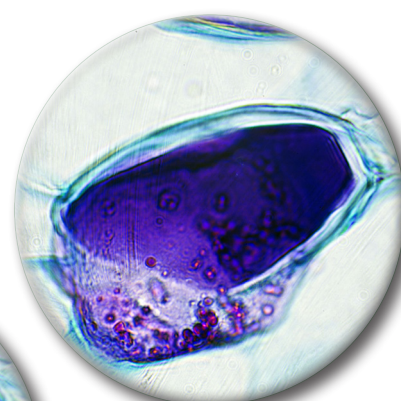

100x OIL

Pine, one year stem.

For a professional use, immersion oil is the recommended solution to get the best performance available from any 100x objective.



Entry-Level Lab Upright Microscopes

Laboratory Grade Optics, N-PLAN & IOS N-PLAN System

OPTIKA N-PLAN objectives ensure bright, clear images with excellent flatness and compensation for chromatic aberration. IOS Infinity-corrected optical system prevents image deterioration even if other optical components are added, such as polarizers, beamsplitters and so on.

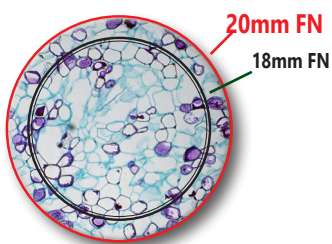

Large Specimen View (20 mm Field Number)

The **F.O.V.** (field of view) is based on a comfortable diameter of 20 mm. This means that a wide area of the sample can be inspected and allows a natural and easy view, particularly needed in a laboratory environment.

Easy Transportation

B-290 has a carefully shaped design that gives stability and ease in the transportation. Thanks to the handle on the back, it can be safely moved around the classroom or the laboratory.



Get the most out of our accessories



M-666.290 Heating stage

Use the temperature controlled heating stage for specific applications where accurate temperature selection up to 50° C and programmable settings are needed. Requested in research arenas such as microbiology, biochemistry, material science, pharmacology, crystallographic characterization, surface quality control, and in all the temperature related inspections.

M-184 Darkfield condenser

With optional diaphragm M-184 you can easily obtain a darkfield view for dry objectives. M-184 can be placed directly under the condenser without the need of additional operations.



B-290 Series

Legend

1. B-290TB with 360° rotating tablet PC for discussion.
2. Pine, one year stem, with B-292 and 10x objective.
3. B-290 Series exclusive X-LED³ illumination system.
4. B-293 used by a teacher.
5. Lilly pollen, with B-292PLi and 20x objective.
6. Ascaris female, with B-293 and 40x objective.
7. Student setting the right focusing on a B-290TB.

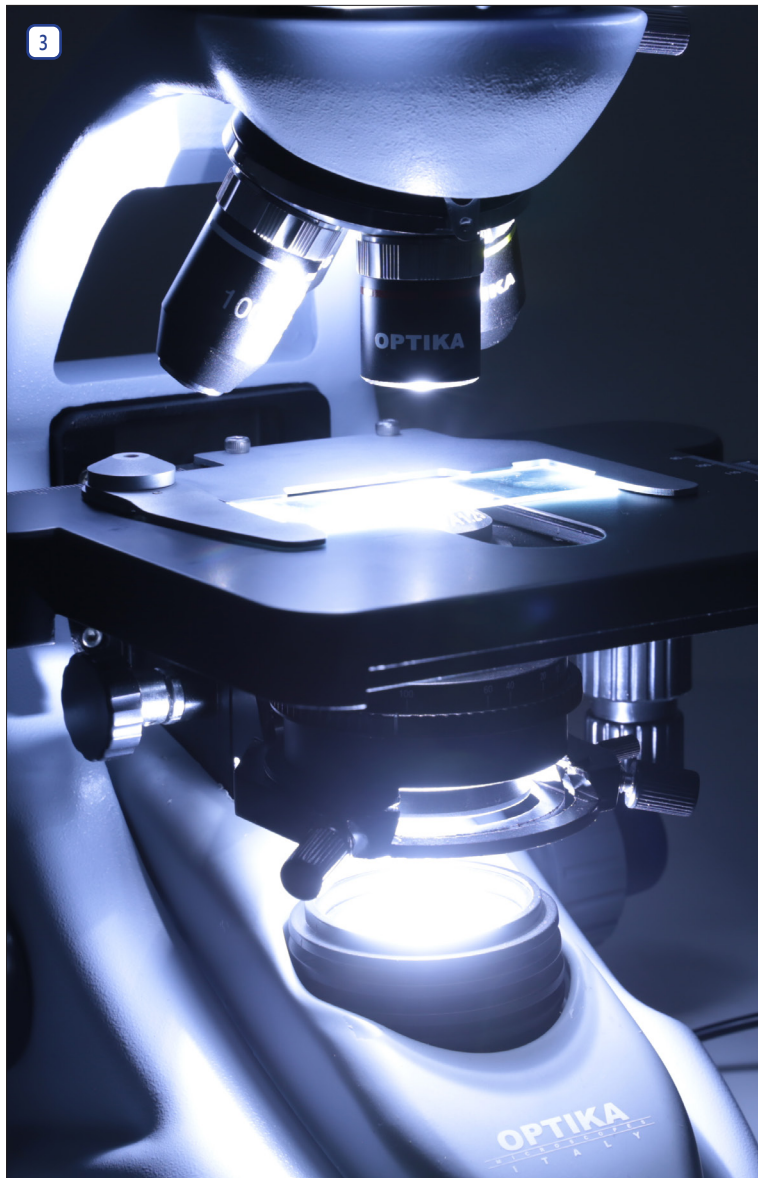
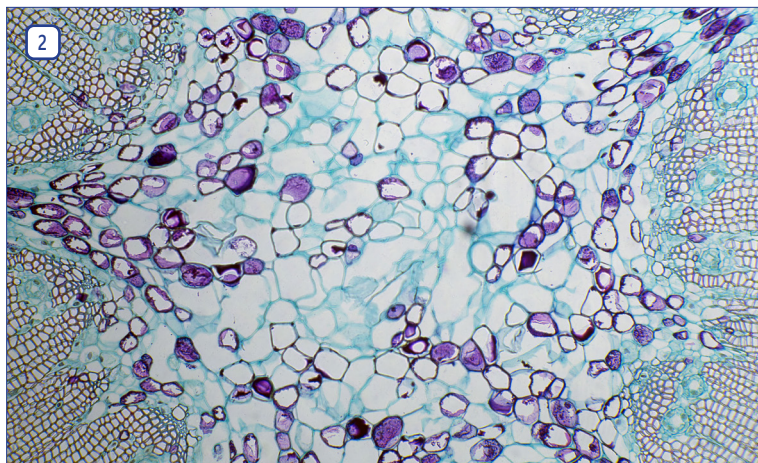

Entry-Level Lab Upright Microscopes

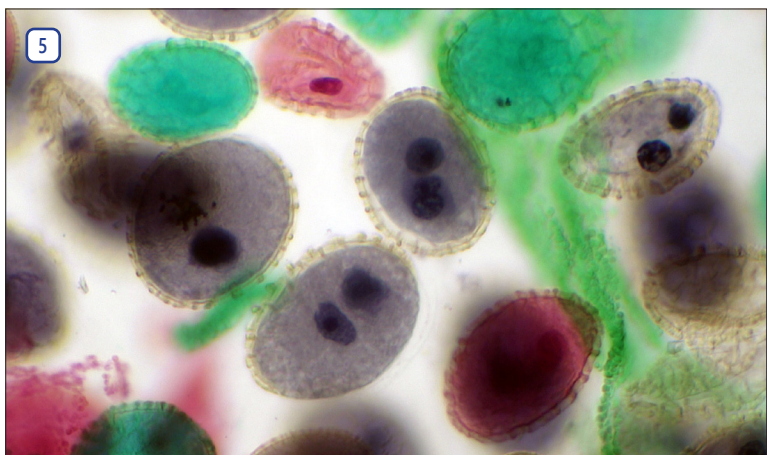

2 B-290 Series - Brightfield Models

B-292



Binocular head with N-PLAN objectives, rackless stage and exclusive **X-LED³** for unmatched performance, powerful and uniform illumination.

Observation mode: Brightfield.

Head: Binocular, 30° inclined and 360° rotating. Interpupillary distance 48-75 mm.

Dioptric adjustment: On both eyepieces.

Eyepieces: WF10x/20 mm, high eye-point and secured by screw.

Nosepiece: Quadruple revolving nosepiece, rotation on ball bearings.

Objectives:

N-PLAN 4x/0.10 N-PLAN 10x/0.25
 N-PLAN 40x/0.65 N-PLAN 100x/1.25 (Oil/Water)
 All with anti-fungus treatment.

Specimen stage: Double layer rackless mechanical sliding stage, 150x139 mm, 75x33 mm X-Y movement range. Vernier scale on the two axes, accuracy: 0.1 mm.

Focusing: Coaxial coarse and fine focusing mechanism with limit stop to prevent the contact between objective and specimen. Adjustable tension of coarse focusing knob.

Condenser: Abbe N.A. 1.25, with objective-coded iris diaphragm, focusable and centerable.

Illumination (Fixed Koehler type): X-LED³ with white 3.6 W LED (6,300 K) and light intensity control.
 Multi-plug 100-240Vac/6Vdc external power supply.

B-293



Trinocular head with N-PLAN objectives, rackless stage and exclusive **X-LED³** for unmatched performance, powerful and uniform illumination.

Observation mode: Brightfield.

Head: Trinocular (fixed, 50/50), 360° rotating and 30° inclined. Interpupillary distance 55-75 mm.

Dioptric adjustment: On both eyepieces.

Eyepieces: WF10x/20 mm, high eye-point and secured by screw.

Nosepiece: Quadruple revolving nosepiece, rotation on ball bearings.

Objectives:

N-PLAN 4x/0.10 N-PLAN 10x/0.25
 N-PLAN 40x/0.65 N-PLAN 100x/1.25 (Oil/Water)
 All with anti-fungus treatment.

Specimen stage: Double layer rackless mechanical sliding stage, 150x139 mm, 75x33 mm X-Y movement range. Vernier scale on the two axes, accuracy: 0.1 mm.

Focusing: Coaxial coarse and fine focusing mechanism with limit stop to prevent the contact between objective and specimen. Adjustable tension of coarse focusing knob.

Condenser: Abbe N.A. 1.25, with objective-coded iris diaphragm, focusable and centerable.

Illumination (Fixed Koehler type): X-LED³ type with white 3.6 W LED (6,300 K) and light intensity control. Multi-plug 100-240Vac/6Vdc external power supply.

B-290 Series - Brightfield Models

B-292PLi



Binocular head with **IOS N-PLAN** (infinity corrected) objectives, rackless stage and exclusive **X-LED³** for incredibly bright illumination.

Observation mode: Brightfield.

Head: Binocular, 360° rotating and 30° inclined. Interpupillary distance 48-75 mm.

Dioptric adjustment: On both eyepieces.

Eyepieces: WF10x/20 mm, high eye-point and secured by screw.

Nosepiece: Quadruple revolving nosepiece, rotation on ball bearings.

Objectives:

IOS N-PLAN 4x/0.10	IOS N-PLAN 10x/0.25
IOS N-PLAN 40x/0.65	IOS N-PLAN 100x/1.25 (Oil/Water)

All with anti-fungus treatment.

Specimen stage: Double layer rackless mechanical sliding stage, 150x139 mm, 75x33 mm X-Y movement range. Vernier scale on the two axes, accuracy: 0.1 mm.

Focusing: Coaxial coarse and fine focusing mechanism with limit stop to prevent the contact between objective and specimen. Adjustable tension of coarse focusing knob.

Condenser: Abbe N.A. 1.25, with objective-coded iris diaphragm, focusable and centerable.

Illumination (Fixed Koehler type): X-LED³ type with white 3.6 W LED (6,300 K) and light intensity control.
Multi-plug 100-240Vac/6Vdc external power supply.

B-293PLi



Trinocular head with **IOS N-PLAN** (infinity corrected) objectives, rackless stage and exclusive **X-LED³** for incredibly bright illumination.

Observation mode: Brightfield.

Head: Trinocular (fixed, 50/50), 360° rotating and 30° inclined. Interpupillary distance 55-75 mm.

Dioptric adjustment: On both eyepieces.

Eyepieces: WF10x/20 mm, high eye-point and secured by screw.

Nosepiece: Quadruple revolving nosepiece, rotation on ball bearings.

Objectives:

IOS N-PLAN 4x/0.10	IOS N-PLAN 10x/0.25
IOS N-PLAN 40x/0.65	IOS N-PLAN 100x/1.25 (Oil/Water)

All with anti-fungus treatment.

Specimen stage: Double layer rackless mechanical sliding stage, 150x139 mm, 75x33 mm X-Y movement range. Vernier scale on the two axes, accuracy: 0.1 mm.

Focusing: Coaxial coarse and fine focusing mechanism with limit stop to prevent the contact between objective and specimen. Adjustable tension of coarse focusing knob.

Condenser: Abbe N.A. 1.25, with objective-coded iris diaphragm, focusable and centerable.

Illumination (Fixed Koehler type): X-LED³ type with white 3.6 W LED (6,300 K) and light intensity control.
Multi-plug 100-240Vac/6Vdc external power supply.

B-290TB - Digital Microscope with Camera & Tablet

B-290TB

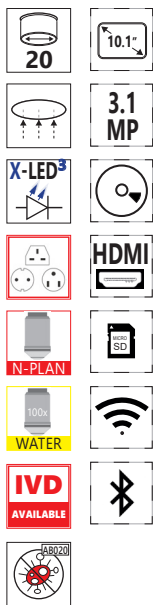

3.1 MP Built-in camera and 10.8" Windows tablet PC with N-PLAN objectives, rackless stage and exclusive **X-LED³** for unmatched performance in illumination. Ideal for discussion group with 360° rotating tablet.

Observation mode: Brightfield.

Head: Binocular, 360° rotating and 30° inclined. Interpupillary distance from 48 to 75 mm; dioptic adjustment on left eyepiece. Built-in 3.1 MP camera.

Dioptic adjustment: On the left eyepiece tube.

Eyepieces: WF10x/20 mm, high eye-point and secured by screw.

Nosepiece: Quadruple revolving nosepiece, rotation on ball bearings.

Objectives:

N-PLAN 4x/0.10

N-PLAN 10x/0.25

N-PLAN 40x/0.65

N-PLAN 100x/1.25 (Oil/Water)

All with anti-fungus treatment.

Specimen stage: Double layer rackless mechanical sliding stage, 150x139 mm, 75x33 mm X-Y movement range. Vernier scale on the two axes, accuracy: 0.1 mm.

Focusing: Coaxial coarse and fine focusing mechanism with limit stop to prevent the contact between objective and specimen. Adjustable tension of coarse focusing knob.

Condenser: Abbe N.A. 1.25, with objective-coded iris diaphragm, focusable and centerable.

Illumination (Fixed Koehler type): X-LED³ type with white 3.6 W LED (6,300 K) and light intensity control. Multi-plug 100-240Vac/6Vdc external power supply.



UNIQUE FEATURES

- » Simultaneous camera & power connection
- » Equipped with the latest Windows OS & Intel processor
- » Easily detachable, can be used as a laptop (keyboard sold separately)

B-290TB - Digital Microscope with Camera & Tablet

The latest OPTIKA digital microscopes with Windows tablet PC open new microscopy horizons, combining high-end optics with innovative digital technology for microscopic imaging. B-290TB includes a 3MP camera with a 10.1" Windows tablet. View, capture, analyze and share your images with simplicity and reliability.

TABLET TECHNICAL SPECIFICATIONS

Operating system	Windows 10 (64Bit)
CPU	Gemini-Lake, N4100
CPU speed	1.10 GHz
Graphic card	Intel® HD Graphics 600
RAM	Ram 6 GB LPDDR3
Display size	LED 10.1" IPS Multi Touch Screen
Display resolution	1920x1200
Storage	Hdd 128 GB
Network	WiFi (2.4G / 5G) - Bluetooth 5.0
Input ports	USB-C (1 USB2.0 for battery charge, 1 USB3.0) - Micro SD card reader
Output ports	Microphone - Headphone - Micro HDMI
Battery Type	Lithium-ion
Battery capacity	6500 mAh
Power consumption	24.05W
Power supply	12V 2A EU
Dimensions (mm)	261 x 167 X 9
Weight (Kg)	0.53
Language	Multilanguage
Weight	530 g
Tablet accessories included	USB cable USB-B to USB-A (0.5m)

Intuitive, Yet Powerful Software

Simple and user-friendly, ideal for students and experienced users.

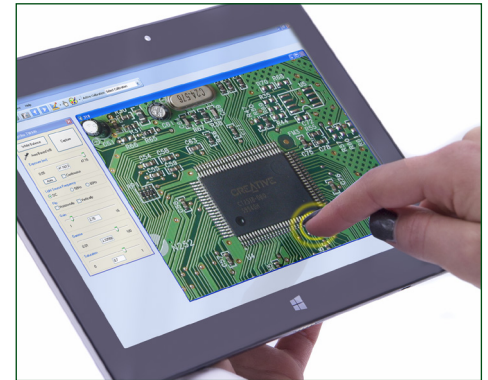

360° Rotating & Tilting



CAMERA TECHNICAL SPECIFICATIONS

Digital camera resolution	3MP
Signal output	USB 2.0
Sensor Size	1/2.5"
Sensor technology	CMOS
Image format	4\3
Full Image size	2048 x 1536
Pixel size	2.2 x 2.2 micron
Frame rate full resolution	5 frames\sec
Frame rate other resolutions	8 fps (1280x1024) - 30 fps (640x480)
Automatic White Balance	Auto - Man
Automatic Gain Control	Auto - Man
Automatic Back light control	Auto - Man
Exposure control	Auto - Man

Detachable



TB-KBD1 - Accessory keyboard for tablet

B-290LD - LED Fluorescence Microscopes



Fluorescence binocular and trinocular microscopes especially designed for tuberculosis and malaria analysis.

Observation mode: Brightfield.

Head: Binocular or trinocular, 360° rotating and 30° inclined. Interpupillary distance 55-75mm.

Dioptric adjustment: On both eyepieces.

Eyepieces: WF10x/20 mm, high eye-point and secured by a screw.

Nosepiece: Quadruple revolving nosepiece, rotation on ball bearings.

Specimen stage: Double layer rackless mechanical sliding stage, 150x139 mm, 75x33 mm X-Y movement range. Vernier scale on the two axes, accuracy: 0.1 mm.

Focusing: Coaxial coarse and fine focusing mechanism with limit stop to prevent the contact between objective and specimen. Adjustable tension of coarse focusing knob.

Condenser: Abbe N.A. 1.25, with objective-coded iris diaphragm, focusable and centerable.

Brightfield Illumination (Fixed Koehler type): X-LED³ with white 3.6 W LED (6,300 K) and light intensity control.

Multi-plug 100-240Vac/6Vdc external power supply.

Fluorescence Illumination: Extra efficiency LED, with light intensity control. Peak wavelength: 465 nm, Power: 3.6W.

Epi Fluorescence Attachment: Slider with 3 positions (2 fluorescence, 1 brightfield), with 1 included filterset: Fluorescence B: EX 460-490, DM 505, EM 515LP: Acridine Yellow, Acridine Orange, Auramine, DiO, DTAF, FITC, GFP, YFP, etc.

Part number: B-292LD1.50

Equipped with binocular head and following objectives:
 IOS N-PLAN 10x/0.25 (Cover/No Cover), with anti-fungus treatment
 IOS N-PLAN 20x/0.40 (Cover/No Cover), with anti-fungus treatment
 IOS N-PLAN 40x/0.65 (Cover/No Cover), with anti-fungus treatment
 IOS W-PLAN MET 50x/0.75 (No Cover), with anti-fungus treatment.

Part number: B-293LD1.50

Trinocular version of B-292LD1.50.

Part number: B-292LD1

Equipped with binocular head and following objectives:
 IOS N-PLAN 10x/0.25 (Cover/No Cover), with anti-fungus treatment
 IOS N-PLAN 20x/0.40 (Cover/No Cover), with anti-fungus treatment
 IOS N-PLAN 40x/0.65 (Cover/No Cover), with anti-fungus treatment
 IOS W-PLAN 100x/0.80 (No Cover, Dry), with anti-fungus treatment.

Part number: B-293LD1

Trinocular version of B-292LD1.

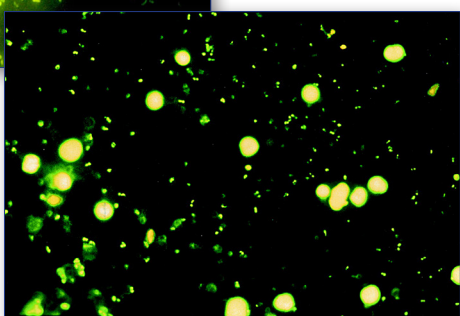
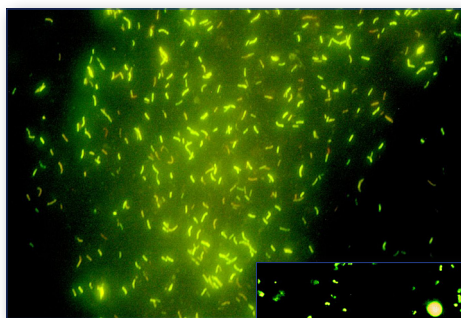

Standard filterset

Name	Excitation filter (nm)	Dichroic mirror cut-off (nm)	Emission filter (nm)
B (Blue)	460 – 490	505	515LP

B-290 Series - Comparison Chart

Model	Head	Eyepieces	Nosepiece	Objectives	Stage	Focusing	Condenser	Illumination
B-292	Binocular, 30° inclined, 360° rotating	WF 10x/20	Quadruple, reversed	N-PLAN 4x, 10x, 40x, 100x (oil/water)	Double layer, 150x139 mm, moving range 75x33 mm, X-axis rackless	Coaxial coarse and fine, limit stop	Abbe N.A. 1.25, iris diaphragm, focusable and centrabale	3.6 W X-LED ³ , brightness control. Fixed Koehler
B-292PLi	Binocular, 30° inclined, 360° rotating	WF 10x/20	Quadruple, reversed	IOS N-PLAN 4x, 10x, 40x, 100x (oil/water)	Double layer, 150x139 mm, moving range 75x33 mm, X-axis rackless	Coaxial coarse and fine, limit stop	Abbe N.A. 1.25, iris diaphragm, focusable and centrabale	3.6 W X-LED ³ , brightness control. Fixed Koehler
B-293	Trinocular, 30° inclined, 360° rotating	WF 10x/20	Quadruple, reversed	N-PLAN 4x, 10x, 40x, 100x (oil/water)	Double layer, 150x139 mm, moving range 75x33 mm, X-axis rackless	Coaxial coarse and fine, limit stop	Abbe N.A. 1.25, iris diaphragm, focusable and centrabale	3.6 W X-LED ³ , brightness control. Fixed Koehler
B-293PLi	Trinocular, 30° inclined, 360° rotating	WF 10x/20	Quadruple, reversed	IOS N-PLAN 4x, 10x, 40x, 100x (oil/water)	Double layer, 150x139 mm, moving range 75x33 mm, X-axis rackless	Coaxial coarse and fine, limit stop	Abbe N.A. 1.25, iris diaphragm, focusable and centrabale	3.6 W X-LED ³ , brightness control. Fixed Koehler
B-290TB	Binocular, 30° inclined, 360° rotating, with tablet	WF 10x/20	Quadruple, reversed	N-PLAN 4x, 10x, 40x, 100x (oil/water)	Double layer, 150x139 mm, moving range 75x33 mm, X-axis rackless	Coaxial coarse and fine, limit stop	Abbe N.A. 1.25, iris diaphragm, focusable and centrabale	3.6 W X-LED ³ , brightness control. Fixed Koehler

Model	Head	Eyepieces	Nosepiece	Objectives	Stage	Condenser	Fluorescence	Illumination
B-292LD1.50	Binocular, 30° inclined, 360° rotating	WF 10x/20	Quadruple, reversed	IOS N-PLAN 10x, 20x, 40x. W-PLAN MET 50x	Double layer, 150x139 mm, moving range 75x33 mm, X-axis rackless	Abbe N.A. 1.25, iris diaphragm, focusable and centrabale	3.6 W Fluo LED; Blue Filterset	3.6 W X-LED ³ , brightness control
B-292LD1	Binocular, 30° inclined, 360° rotating	WF 10x/20	Quadruple, reversed	IOS N-PLAN 10x, 20x, 40x. W-PLAN 100x (dry)	Double layer, 150x139 mm, moving range 75x33 mm, X-axis rackless	Abbe N.A. 1.25, iris diaphragm, focusable and centrabale	3.6 W Fluo LED; Blue Filterset	3.6 W X-LED ³ , brightness control
B-293LD1.50	Trinocular, 30° inclined, 360° rotating	WF 10x/20	Quadruple, reversed	IOS N-PLAN 10x, 20x, 40x. W-PLAN MET 50x	Double layer, 150x139 mm, moving range 75x33 mm, X-axis rackless	Abbe N.A. 1.25, iris diaphragm, focusable and centrabale	3.6 W Fluo LED; Blue Filterset	3.6 W X-LED ³ , brightness control
B-293LD1	Trinocular, 30° inclined, 360° rotating	WF 10x/20	Quadruple, reversed	IOS N-PLAN 10x, 20x, 40x. W-PLAN 100x (dry)	Double layer, 150x139 mm, moving range 75x33 mm, X-axis rackless	Abbe N.A. 1.25, iris diaphragm, focusable and centrabale	3.6 W Fluo LED; Blue Filterset	3.6 W X-LED ³ , brightness control

Optical performance B-292, B-293 and B-290TB

Eyepiece		10x (M-160)			15x (M-161)		20x (M-162)	
Field number (mm)		20			16		10	
Objective	N.A.	W.D (mm)	Total magnification	Field of View (mm)	Total magnification	Field of View (mm)	Total magnification	Field of View (mm)
4x (N-PLAN 160 mm)	0.10	15.20	40x	5	60x	4	80x	2.5
10x (N-PLAN 160 mm)	0.25	5.50	100x	2	150x	1.6	200x	1
20x (N-PLAN 160 mm)	0.40	5.00	200x	1	300x	0.8	400x	0.5
40x (N-PLAN 160 mm)	0.65	0.45	400x	0.5	300x	0.4	800x	0.25
60x (N-PLAN 160 mm)	0.80	0.13	600x	0.33	900x	0.26	1200x	0.16
100x (N-PLAN 160 mm)	1.25 (oil/water)	0.13	1000x	0.2	1500x	0.16	2000x	0.1

Optical performance B-292PLi, B-293PLi and LD models

Eyepiece		10x (M-160)			15x (M-161)		20x (M-162)	
Field number (mm)		20			16		10	
Objective	N.A.	W.D (mm)	Total magnification	Field of View (mm)	Total magnification	Field of View (mm)	Total magnification	Field of View (mm)
4x (IOS N-PLAN)	0.10	16.80	40x	5	60x	4	80x	2.5
10x (IOS N-PLAN)	0.25	5.80	100x	2	150x	1.6	200x	1
20x (IOS N-PLAN)	0.40	5.10	200x	1	300x	0.8	400x	0.5
40x (IOS N-PLAN)	0.65	0.43	400x	0.5	300x	0.4	800x	0.25
50x (IOS W-PLAN MET, no cover)	0.75	0.32	500x	0.4	750x	0.32	1000x	0.2
60x (IOS N-PLAN)	0.80	0.14	600x	0.33	900x	0.26	1200x	0.16
100x (IOS N-PLAN)	1.25 (oil/water)	0.13	1000x	0.2	1500x	0.16	2000x	0.1
100x (IOS W-PLAN, no cover)	0.80 (dry)	3.20	1000x	0.2	1500x	0.16	2000x	0.1

B-290 Series - Accessories

Eyecups & Eyepieces

M-001	Huygens 5x eyepiece
M-008.1	WF10x/20 eyepiece, high eyepoint, with pointer, rubber cup
M-160	EW10x/20 eyepiece, high eyepoint, with rubber cup
M-161	EW15x/16 eyepiece, with rubber cup
M-162	WF20x/10 eyepiece
M-163	EW10x/20 micrometric eyepiece, high eyepoint, with rubber cup

Objectives

N-PLAN

M-164	N-PLAN objective 4x/0.10
M-165	N-PLAN objective 10x/0.25
M-166	N-PLAN objective 20x/0.40
M-167	N-PLAN objective 40x/0.65
M-168	N-PLAN objective 60x/0.85
M-169	N-PLAN objective 100x/1.25 (oil)

IOS N-PLAN

M-144	IOS N-PLAN objective 4x/0.10
M-145	IOS N-PLAN objective 10x/0.25
M-146	IOS N-PLAN objective 20x/0.40
M-147	IOS N-PLAN objective 40x/0.65
M-149	IOS N-PLAN objective 60x/0.80
M-148	IOS N-PLAN objective 100x/1.25 (oil)

IOS W-PLAN

M-634.1	IOS W-PLAN objective 50x/0.95 (oil)
M-1120.N	IOS W-PLAN PH objective 10x/0.25
M-1121.N	IOS W-PLAN PH objective 20x/0.40
M-1122.N	IOS W-PLAN PH objective 40x/0.65
M-335	IOS W-PLAN MET objective 50x/0.75
M-698.2	IOS W-PLAN MET objective 100x/0.80 (dry)

Stages

M-175	Rotating stage for polarising set (for 150x139mm rackless stage)
M-666.290	Heating stage (on newly purchased microscopes, for 150x139mm stage), multiplug

Condensers & Filters

M-174	Polarising set (filters only)
M-184	Darkfield stop for condenser
M-971	Plane-concave mirror, with base
M-975	Blue filter, 45mm diameter
M-977	Green filter, 45mm diameter
M-979	Yellow filter, 45mm diameter
M-989	Frosted glass filter, 45mm diameter
M-1124.1	Brightfield condenser (with phase slider slot) (except for B-292, B-293 and B-290TB)
M-1124.NO	Phase contrast condenser with insert slide 10x/20x-40x (except for B-292, B-293 and B-290TB)

Camera Adapters

M-114	0.5x C-Mount projection lens
M-115	0.35x C-Mount projection lens
M-118	0.75x C-Mount projection lens
M-173	Photo adapter for APS-C and full frame reflex cameras (trino head)

Miscellaneous

15104	Cleaning kit
15008	Immersion oil, 10ml
15009	Immersion oil, 100ml
DC-002	Plastic dust cover, medium, 490(l)x490(h) mm (except for B-290TB)
DC-003	TNT dust cover, medium, 600(l)x550(h) mm (only for B-290TB)
TB-KBD1	Keyboard for tablet (only for B-290TB)
M-005	Micrometric slide, 26x76mm, with 2 scales (1mm/100 & 10mm/100)
M-069	Solar charger
M-1380	Centering telescope, 23mm diameter (except for B-292, B-293 and B-290TB)
VP-290	IQ/OQ/PQ manual for B-290 series
VP-TB	IQ/OQ/PQ manual for TB series
AB-020	Antibacterial surface treatment, only for newly purchased microscope

M-069 - Solar charger

Included battery: rechargeable – Lithium-Poly.
Capacity: 2500 mAh. - Output voltage: 5 Vdc.
Autonomy: over 6 hours at medium intensity (X-LED³).
Charging models: with solar panel (12h),
with external USB power supply (2.5h)



15104 - Cleaning kit

It cleans glass quickly and effectively, without leaving residue or odor. Ideal for precision lens or prism cleaning.



How to connect the cameras to our microscopes.

Please refer to the Adapter reference list on Digital section.

v 6.6.0 - OPTIKA reserves the right to make corrections, modifications, enhancements, improvements and other changes to its products at any time without notice.

Headquarters and Manufacturing Facilities

OPTIKA® S.r.l. Via Rigla, 30 - 24010 Ponteranica (BG) - ITALY - Tel.: +39 035.571.392 - info@optikamicroscopes.com

Optika Sales branches

OPTIKA® Spain spain@optikamicroscopes.com
OPTIKA® China china@optikamicroscopes.com
OPTIKA® India india@optikamicroscopes.com

OPTIKA® USA usa@optikamicroscopes.com
OPTIKA® Central America camerica@optikamicroscopes.com

B-380 Series



Middle-Level Routine Lab Upright Microscopes

Just What You Need. Right When Is Needed

ROUTINE IN UNIVERSITIES, LABS & INDUSTRIES

- » Wide range to fulfil specific lab requirements
- » Valuable solutions for life and material sciences
- » Compliant with several observation methods

THE PREFERRED PARTNER FOR ROUTINE TASKS

- » Full planarity optics on 20 mm (N-PLAN) according to ISO 19012-1
- » Fixed Koehler illumination for crisp and contrasted images
- » Rounded edge, rackless stage to prevent scratches



Multiple Observation Methods

BRIGHTFIELD

METALLOGRAPHY

DARKFIELD

POLARIZATION

FLUORESCENCE

PHASE CONTRAST

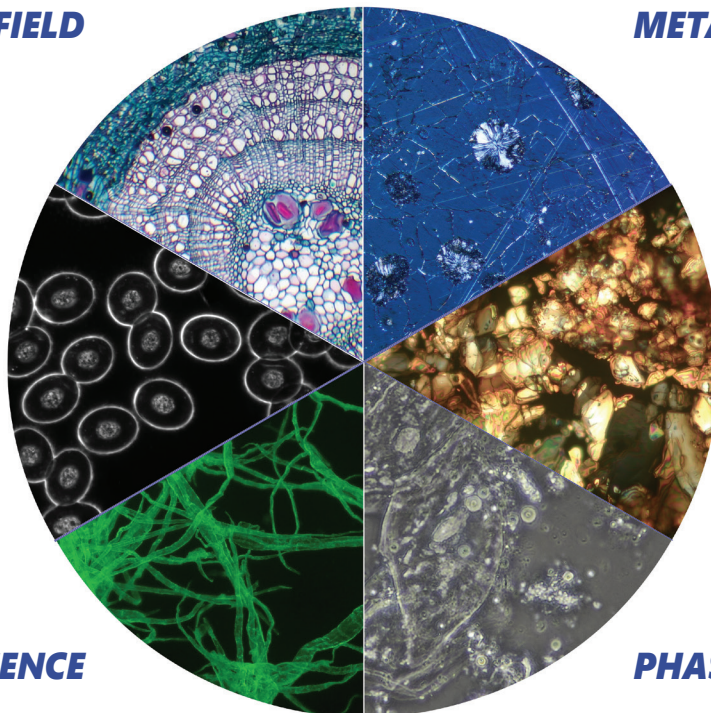

100x Oil/Water Objective – Only at OPTIKA

2

SAME OBJECTIVE FOR OIL AND WATER USE

- » Oil represents the best media for high numerical aperture
- » Water combines results with convenience
- » Water is recommended especially for educational purposes

UNPARALLELED TIME & MONEY SAVING

- » Save time by forgetting about tedious cleaning
- » No time-wasting procedures for maintenance
- » No additional expenses due to inappropriate cleaning

Laboratory

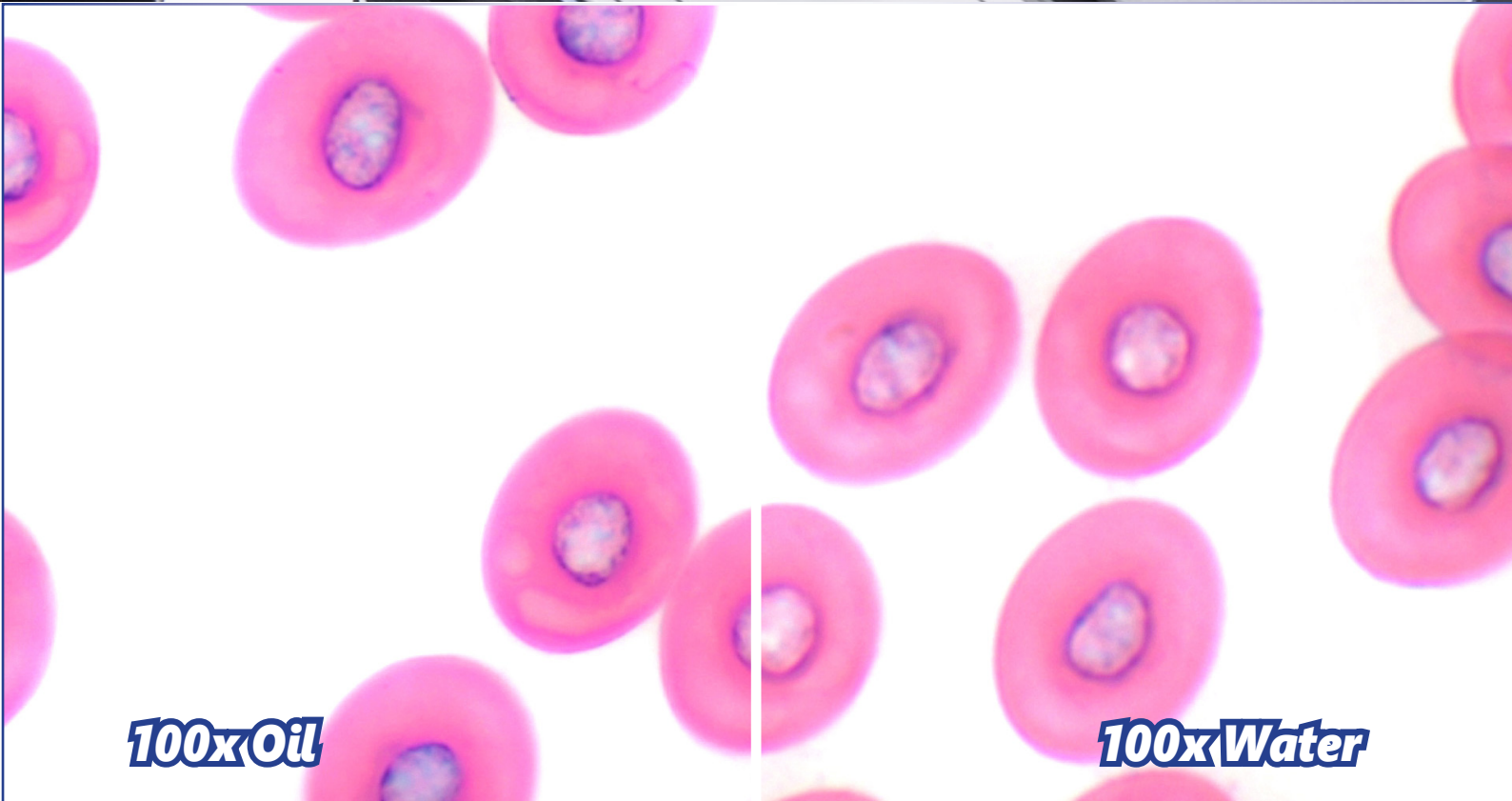

100x Oil

100x Water

X-LED³ – Only Available at OPTIKA

STATE-OF-THE-ART ILLUMINATION SYSTEM

- » Uncomparable light intensity, exclusive lens & collector design
- » Constant pure-white colour temperature at all intensity levels
- » Unmatched color fidelity, uniformity and brightness

CUT ELECTRICITY BILLS BY 90%

- » Money & energy saving, only 3.6 W
- » More efficient brightness than a 50 W halogen lamp
- » LED long lifetime (65,000 hours = 22 years at 8 hours/day usage)

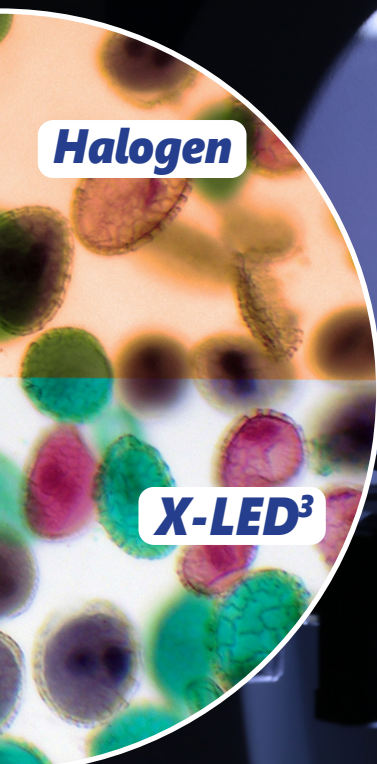

Multi-plug power supply

ALC - Only Available At OPTIKA

2

AUTOMATIC LIGHT CONTROL IN 3 STEPS

- » When another objective is used
- » When the diaphragm aperture changes
- » When processing samples with different opacity

FORGET ABOUT MANUAL LIGHT ADJUSTEMENT

- » Choose the light intensity according to your preference
- » Press the ALC button and the brightness is saved
- » The microscope will automatically regulate the light

Laboratory

STEP 1

Set the brightness according to your preferences.



STEP 2

Press the ALC button to save the brightness level.



STEP 3

Forget about the illumination!

The microscope will automatically adjust the brightness for you, in case of:

- Another objective is used
- The diaphragm aperture is changed
- Another specimen with different opacity is processed



B-380 Series

This series incorporates all the experience gathered by OPTIKA Microscopes in the field of light microscopy, adapted specifically for common laboratory applications. Suitable for routine microscopy with brightfield, darkfield (oil and dry), phase contrast, fluorescence and polarized light, designed to be extremely stable on the bench and last long.

Purposely Designed For Intense Use, Effortless

Full of features that help being more comfortable especially in case of long-term use. All the main controls are located close to each other to enable minimal movements and reinforce the advantages that the ergonomics brings to this series.

X-LED³ Exclusive Lighting Source

Special technology able to double the light intensity for incomparable performance, ensuring constant pure-white colour temperature (6,300K colour temperature). Relevant money and energy saving thanks to the incredibly low energy consumptions which allows you to cut the electricity bills by 90%! The electric consumption (3.6 W only) proves the high efficiency of this system: incredibly high light intensity combined with low consumption.

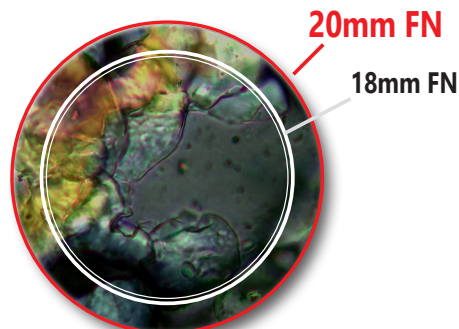

Large Specimen View (20 mm Field Number)

The **F.O.V.** (field of view) is based on a comfortable diameter of 20 mm.

This means that a wide area of the sample can be inspected and allows a natural and easy view, particularly needed in a laboratory environment.

ALC - Automatic Light Control, Only Available At OPTIKA

Incomparable Comfort With The Exclusive Automatic Light Control (ALC)

Light intensity is automatically adjusted by the microscope itself in order to maintain the same level as the one the user has previously chosen.

No matter if the aperture of the diaphragm changes, if another objective is used, and if the opacity of the sample is different...the microscope will set the light for you according to your preferences.

On **ALC Models**.

Safe And Convenient Operations

Rounded edge rackless stage has been designed with a belt-driven mechanism that allows a smooth movement without any protruding part. This design gives you a more compact solution and lowers any risk of injury after accidentally hitting the rack with your hands.



Middle-Level Routine Lab Upright Microscopes

Universal Condenser For Brightfield, Darkfield & Phase

OPTIKA B-380 phase contrast microscopes are equipped with a 5-position dedicated rotating condenser for brightfield (standard use), phase contrast (10x/20x, 40x and 100x phase diaphragms), and a darkfield position for dry objectives.



Exclusive X-LED³ Darkfield Condenser

The special condenser with integrated, exclusive X-LED³ illuminator replaces any other external and expensive lighting source required for these applications and is ideal for great-looking, rich and high-quality specimen view.

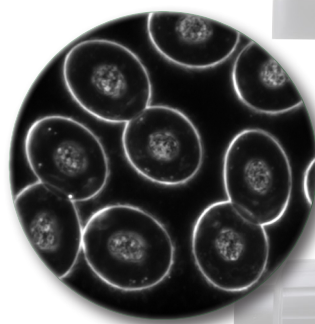

In fluorescence we can offer several options.

According to your application and to the fluorochromes you are using, we can help you to identify the best light source.

Traditional, HBO Fluorescence

- » The most used and diffused method, worldwide
- » Wide spectrum range for future upgrades

Innovative, LED Fluorescence

- » Recommended for routine applications
- » Cost-effective, money saving technology
 - » Ready for immediate operation
 - » Eliminate warm-up/cool-down times
 - » Forget lamp replacement & centering



B-380 Series

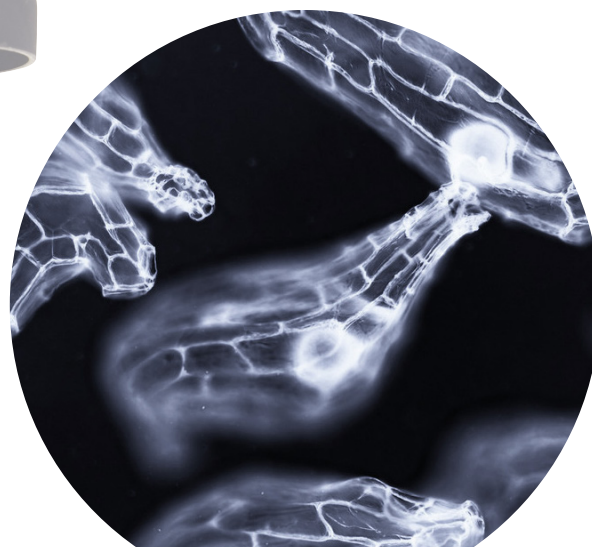

10x - Darkfield

M-185 Darkfield condenser (dry)

With M-185 optional condenser you can easily obtain a darkfield view for dry objectives.

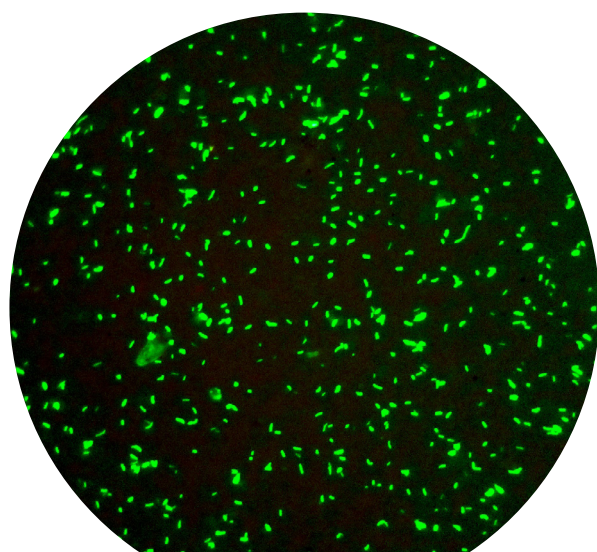

50x - Fluorescence

M-335 Objective 50x/0.75 IOS W-PLAN MET

For applications where no cover slide is required (such as sputum smear analysis for tuberculosis diagnosis), the M-335 objective provides excellent results for stunning images.



Middle-Level Routine Lab Upright Microscopes

Get the most of our accessories

M-181

Complete Phase Contrast Set with IOS W-PLAN PH obj. 10x, 20x, 40x, 100x, with Darkfield position

The B-380 series can be upgraded at any time with phase contrast kits (M-179 with W-PLAN PH objectives and M-181 with IOS W-PLAN PH objectives) including all the components you need to inspect transparent specimens such as microorganisms, thin tissue slices, lithographic patterns, fibers, glass, etc.

M-975.1 Ring with blue filter;

Increase the colour temperature of light (toward the blue).

M-977.1 Ring with green filter;

Optimize the resolution of phase contrast.

M-979.1 Ring with yellow filter;

Decrease the colour temperature of light (toward the red).

M-989.1 Ring with frosted glass filter;

Increase the uniformity of illumination, even further.

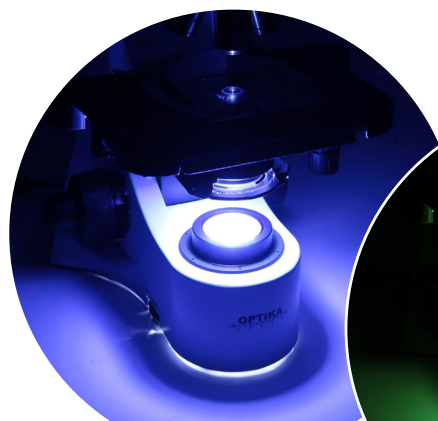

Blue filter



Green filter

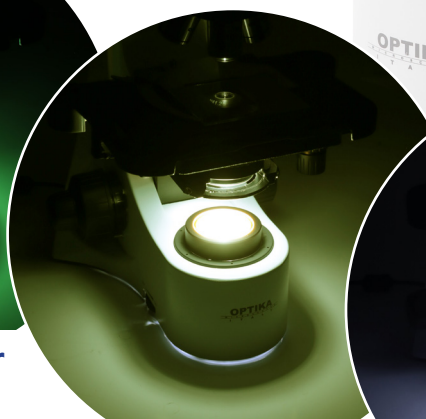

Yellow filter



Frosted glass

M-156 Koehler field diaphragm

Additional field diaphragm for upgrading the Fixed Koehler illumination system to a Full Koehler type. To be ordered on newly purchased B-380 microscope.

M-975 Blue filter;

Increase the colour temperature of light (toward the blue).

M-977 Green filter;

Optimize the resolution of phase contrast.

M-979 Yellow filter;

Decrease the colour temperature of light (toward the red).

M-989 Frosted glass filter;

Increase the uniformity of illumination, even further.

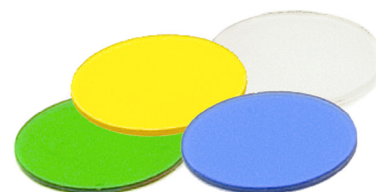

B-380 Series

Legend

1. Planachromatic Phase Contrast objectives.
2. Coded iris diaphragm for each objective.
3. B-383POL, tuff observed under polarized light.
4. Tilia three year stem at 4x magnification, B-383PL.
5. B-380 head with built-in Automatic Light Control system.
6. Head with Siedentopf adjustment system.
7. B-383POL attachment with Bertrand lens.
8. Handle for easy and comfortable transportation.
9. Coin at 4x magnification, B-383MET.
10. Coin at 50x magnification, B-383MET.
11. Innovative design of B-380 series.

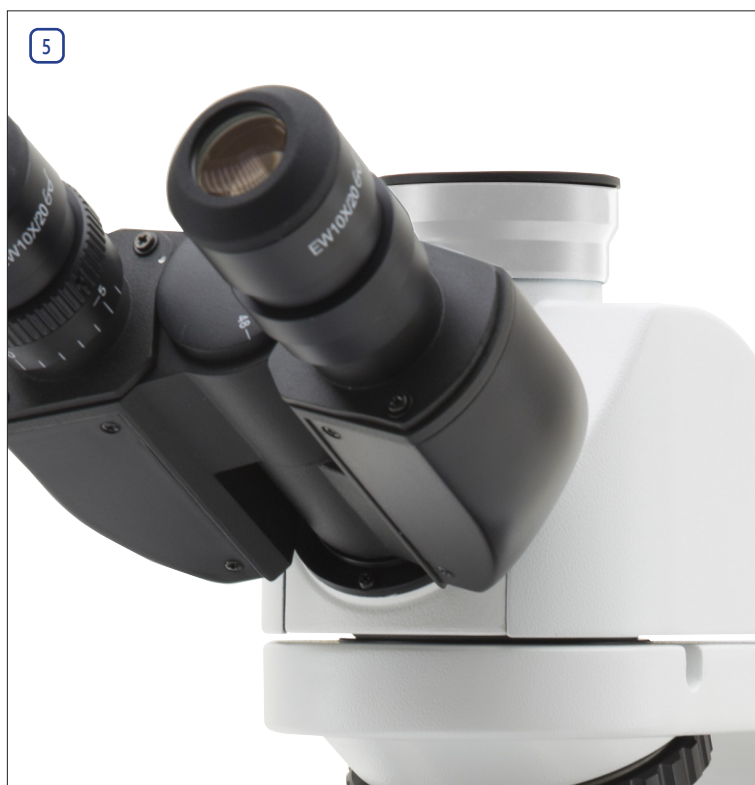
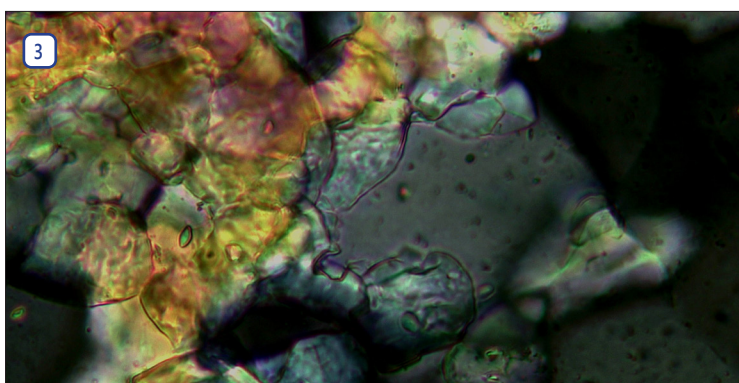

Middle-Level Routine Lab Upright Microscopes

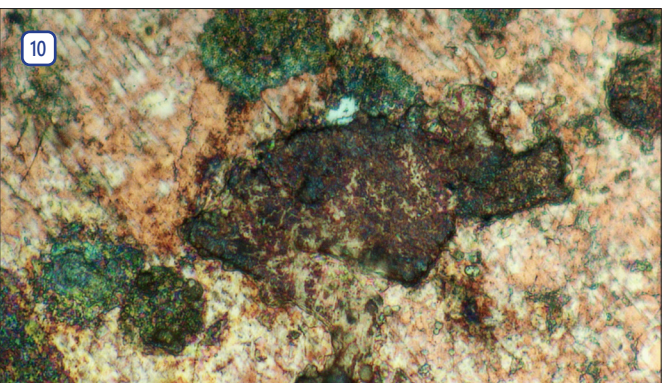
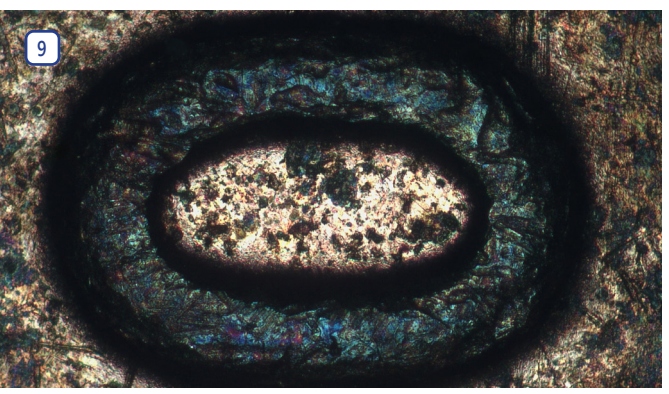

② B-380 Series - Brightfield Models

B-382PL-ALC



Brightfield binocular microscope with N-PLAN objectives, rackless stage and combining the exclusive **X-LED³** with **ALC** (Automatic Light Control) for great-looking, rich and high-quality view.

- Observation mode:** Brightfield.
- Head:** Binocular, 30° inclined, 360° rotating (when ALC cable is unplugged).
- Interpupillary distance:** Adjustable between 48 and 75 mm.
- Dioptric adjustment:** On the left eyepiece tube.
- Eyepieces:** WF10x/20 mm, high eye-point and secured by screw.
- Nosepiece:** Quintuple revolving nosepiece, rotation on ball bearings.
- Objectives:**

N-PLAN 4x/0.10	N-PLAN 10x/0.25
N-PLAN 40x/0.65	N-PLAN 100x/1.25 (Oil/Water)

All with anti-fungus treatment.
- Specimen stage:** Double layer rackless mechanical stage, 150x139 mm, 75x33 mm X-Y range.
- Focusing:** Coaxial coarse (adjustable tension) and fine focusing mechanism with limit stop to prevent the contact between objective and specimen.
- Condenser:** Abbe N.A. 1.25, with objective-coded iris diaphragm, focusable and centerable.
- Illumination (Fixed Koehler type):** X-LED³ with white 3.6 W LED (6,300K) and brightness control. **ALC** system.
Multi-plug 100-240Vac/6Vdc external power supply.

B-383PL



Brightfield trinocular microscope with N-PLAN objectives, rackless stage and the exclusive **X-LED³** for great-looking, rich and high-quality view.

- Observation mode:** Brightfield.
- Head:** Trinocular (fixed 50/50), 30° inclined, 360° rotating.
- Interpupillary distance:** Adjustable between 48 and 75 mm.
- Dioptric adjustment:** On the left eyepiece tube.
- Eyepieces:** WF10x/20 mm, high eye-point and secured by screw.
- Nosepiece:** Quintuple revolving nosepiece, rotation on ball bearings.
- Objectives:**

N-PLAN 4x/0.10	N-PLAN 10x/0.25
N-PLAN 40x/0.65	N-PLAN 100x/1.25 (Oil/Water)

All with anti-fungus treatment.
- Specimen stage:** Double layer rackless mechanical stage, 150x139 mm, 75x33 mm X-Y range.
- Focusing:** Coaxial coarse (adjustable tension) and fine focusing mechanism with limit stop to prevent the contact between objective and specimen.
- Condenser:** Abbe N.A. 1.25, with objective-coded iris diaphragm, focusable and centerable.
- Illumination (Fixed Koehler type):** X-LED³ with white 3.6 W LED (6,300K) with brightness control.
Multi-plug 100-240Vac/6Vdc external power supply.

B-380 Series - Brightfield Models

2

Laboratory

B-382PLi-ALC



Brightfield binocular microscope with IOS N-PLAN (Infinity Corrected) objectives, rackless stage and combining the exclusive **X-LED³** with **ALC** (Automatic Light Control) for great-looking, rich and high-quality view.

Observation mode: Brightfield.

Head: Binocular, 30° inclined, 360° rotating (when ALC cable is unplugged).

Interpupillary distance: Adjustable between 48 and 75 mm.

Dioptric adjustment: On the left eyepiece tube.

Eyepieces: WF10x/20 mm, high eye-point and secured by screw.

Nosepiece: Quintuple revolving nosepiece, rotation on ball bearings.

Objectives:

IOS N-PLAN 4x/0.10	IOS N-PLAN 10x/0.25
IOS N-PLAN 40x/0.65	IOS N-PLAN 100x/1.25 (Oil/Water)

All with anti-fungus treatment.

Specimen stage: Double layer rackless mechanical stage, 233x147 mm, 78x54 mm X-Y range.

Focusing: Coaxial coarse (adjustable tension) and fine focusing mechanism with limit stop to prevent the contact between objective and specimen.

Condenser: Abbe N.A. 1.25, with objective-coded iris diaphragm, focusable and centerable.

Illumination (Fixed Koehler type): X-LED³ with white 3.6 W LED (6,300K) and brightness control. **ALC** system.
Multi-plug 100-240Vac/6Vdc external power supply.

B-383PLi



Brightfield trinocular microscope with IOS N-PLAN (Infinity Corrected) objectives, rackless stage and the exclusive **X-LED³** for great-looking, rich and high-quality view.

Observation mode: Brightfield.

Head: Trinocular (fixed 50/50), 30° inclined, 360° rotating.

Interpupillary distance: Adjustable between 48 and 75 mm.

Dioptric adjustment: On the left eyepiece tube.

Eyepieces: WF10x/20 mm, high eye-point and secured by screw.

Nosepiece: Quintuple revolving nosepiece, rotation on ball bearings.

Objectives:

IOS N-PLAN 4x/0.10	IOS N-PLAN 10x/0.25
IOS N-PLAN 40x/0.65	IOS N-PLAN 100x/1.25 (Oil/Water)

All with anti-fungus treatment.

Specimen stage: Double layer rackless mechanical stage, 233x147 mm, 78x54 mm X-Y range.

Focusing: Coaxial coarse (adjustable tension) and fine focusing mechanism with limit stop to prevent the contact between objective and specimen.

Condenser: Abbe N.A. 1.25, with objective-coded iris diaphragm, focusable and centerable.

Illumination (Fixed Koehler type): X-LED³ with white 3.6 W LED (6,300K) with brightness control. Multi-plug 100-240Vac/6Vdc external power supply.

B-380 Series - Phase Contrast Models

B-382PH-ALC



Phase contrast, darkfield and brightfield binocular microscope with W-PLAN objectives, rackless stage and combining the exclusive **X-LED³** with **ALC** (Automatic Light Control) for great-looking, rich and high-quality view.

Observation mode: Brightfield, phase contrast and darkfield (dry).

Head: Binocular, 30° inclined, 360° rotating (when ALC cable is unplugged).

Interpupillary distance: Adjustable between 48 and 75 mm.

Dioptric adjustment: On the left eyepiece tube.

Eyepieces: WF10x/20 mm, high eye-point and secured by screw.

Nosepiece: Quintuple revolving nosepiece, rotation on ball bearings.

Objectives:
 N-PLAN 4x/0.10 W-PLAN PH 10x/0.25
 W-PLAN PH 40x/0.65 W-PLAN PH 100x/1.25 (Oil/Water)
 All with anti-fungus treatment.

Specimen stage: Double layer rackless mechanical stage, 150x139 mm, 75x33 mm X-Y range.

Focusing: Coaxial coarse (adjustable tension) and fine focusing mechanism with limit stop to prevent the contact between objective and specimen.

Condenser: Phase condenser (10x/20x, 40x, 100x) with darkfield (dry) and brightfield.

Illumination (Fixed Koehler type): X-LED³ with white 3.6 W LED (6,300K) and brightness control. **ALC** system.
 Multi-plug 100-240Vac/6Vdc external power supply.

B-383PH

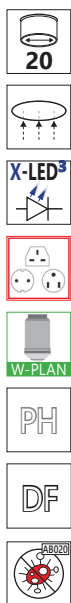

Phase contrast, darkfield and brightfield trinocular microscope with W-PLAN objectives, rackless stage and the exclusive **X-LED³** for great-looking, rich and high-quality view.

Observation mode: Brightfield, phase contrast and darkfield (dry).

Head: Trinocular (fixed 50/50), 30° inclined, 360° rotating.

Interpupillary distance: Adjustable between 48 and 75 mm.

Dioptric adjustment: On the left eyepiece tube.

Eyepieces: WF10x/20 mm, high eye-point and secured by screw.

Nosepiece: Quintuple revolving nosepiece, rotation on ball bearings.

Objectives:
 N-PLAN 4x/0.10 W-PLAN PH 10x/0.25
 W-PLAN PH 40x/0.65 W-PLAN PH 100x/1.25 (Oil/Water)
 All with anti-fungus treatment.

Specimen stage: Double layer rackless mechanical stage, 150x139 mm, 75x33 mm X-Y range.

Focusing: Coaxial coarse (adjustable tension) and fine focusing mechanism with limit stop to prevent the contact between objective and specimen.

Condenser: Phase condenser (10x/20x, 40x, 100x) with darkfield (dry) and brightfield.

Illumination (Fixed Koehler type): X-LED³ with white 3.6 W LED (6,300K) with brightness control. Multi-plug 100-240Vac/6Vdc external power supply.

B-380 Series - Phase Contrast Models

2

Laboratory

B-382Phi-ALC



Phase contrast, darkfield and brightfield binocular microscope with IOS W-PLAN (Infinity Corrected) objectives, rackless stage and combining the exclusive **X-LED³** with **ALC** (Automatic Light Control) for great-looking, rich and high-quality view.

Observation mode: Brightfield, phase contrast and darkfield (dry).

Head: Binocular, 30° inclined, 360° rotating (when ALC cable is unplugged).

Interpupillary distance: Adjustable between 48 and 75 mm.

Dioptric adjustment: On the left eyepiece tube.

Eyepieces: WF10x/20 mm, high eye-point and secured by screw.

Nosepiece: Quintuple revolving nosepiece, rotation on ball bearings.

Objectives:

IOS W-PLAN PH 10x/0.25 IOS W-PLAN PH 20x/0.40
IOS W-PLAN PH 40x/0.65 IOS W-PLAN PH 100x/1.25 (Oil)
All with anti-fungus treatment.

Specimen stage: Double layer rackless mechanical stage, 233x147 mm, 78x54 mm X-Y range.

Focusing: Coaxial coarse (adjustable tension) and fine focusing mechanism with limit stop to prevent the contact between objective and specimen.

Condenser: Phase condenser (10x/20x, 40x, 100x) with darkfield (dry) and brightfield.

Illumination (Fixed Koehler type): X-LED³ with white 3.6 W LED (6,300K) and brightness control. **ALC** system. Multi-plug 100-240Vac/6Vdc external power supply.

B-383Phi



Phase contrast, darkfield and brightfield microscope with IOS W-PLAN (Infinity Corrected) objectives, rackless stage and the exclusive **X-LED³** for great-looking, rich and high-quality view.

Observation mode: Brightfield, phase contrast and darkfield (dry).

Head: (50/50), 30° inclined, 360° rotating.

Interpupillary distance: Adjustable between 48 and 75 mm.

Dioptric adjustment: On the left eyepiece tube.

Eyepieces: WF10x/20 mm, high eye-point and secured by screw.

Nosepiece: Quintuple revolving nosepiece, rotation on ball bearings.

Objectives:

IOS W-PLAN PH 10x/0.25 IOS W-PLAN PH 20x/0.40
IOS W-PLAN PH 40x/0.65 IOS W-PLAN PH 100x/1.25 (Oil)
All with anti-fungus treatment.

Specimen stage: Double layer rackless mechanical stage, 233x147 mm, 78x54 mm X-Y range.

Focusing: Coaxial coarse (adjustable tension) and fine focusing mechanism with limit stop to prevent the contact between objective and specimen.

Condenser: Phase condenser (10x/20x, 40x, 100x) with darkfield (dry) and brightfield.

Illumination (Fixed Koehler type): X-LED³ with white 3.6 W LED (6,300K) with brightness control. Multi-plug 100-240Vac/6Vdc external power supply.

2 B-383DK - Darkfield Microscope

Laboratory upright microscope for brightfield and darkfield observations with N-PLAN objectives (and W-PLAN 100x with iris) for biology and especially darkfield fresh blood analysis and the exclusive **X-LED³** illumination system. The special condenser with integrated, exclusive X-LED3 illuminator replaces any other external and expensive lighting source required for these applications and is ideal for great-looking, rich and high-quality specimen view. Our immersion darkfield system provides the same result achieved by 150W external illuminators in combination with traditional cardioid darkfield condenser.

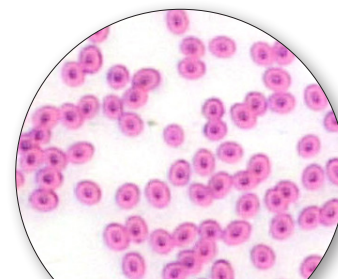

10x

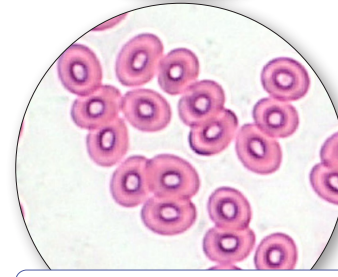

40x

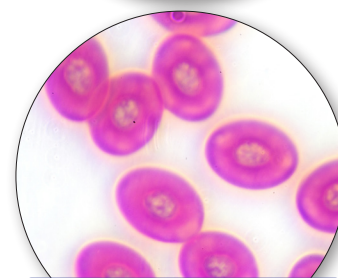

100x Brightfield

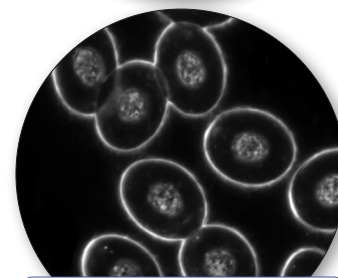

100x Darkfield

Part	Description
Observation mode:	Brightfield, oil immersion darkfield.
Head:	Trinocular (fixed 50/50), 30° inclined, 360° rotating.
Interpupillary distance:	Adjustable between 48 and 75 mm.
Dioptric adjustment:	On the left eyepiece tube.
Eyepieces:	WF10x/20 mm, high eye-point and secured by screw.
Nosepiece	Quintuple revolving nosepiece, rotation on ball bearings.
Objectives:	N-PLAN 4x/0.10 N-PLAN 10x/0.25 N-PLAN 40x/0.65 W-PLAN 100x/1.25 (oil) with iris All with anti-fungus treatment.

Part	Description
Specimen stage:	Double layer rackless mechanical stage, 150x139 mm, 75x33 mm X-Y range.
Focusing:	Coaxial coarse (adjustable tension) and fine focusing mechanism with limit stop to prevent the contact between objective and specimen.
Brightfield condenser:	Abbe N.A. 1.25, with objective-coded iris diaphragm, focusable and centerable.
Darkfield condenser:	Darkfield N.A. 1.36 (oil immersion) with built-in X-LED ³ .
Transmitted illumination (Fixed Koehler type):	X-LED ³ with white 3.6 W LED (6,300K) with brightness control. Multi-plug 100-240Vac/6Vdc external power supply.

B-383FL - HBO Fluorescence Microscope

2

Laboratory

Laboratory upright microscope for brightfield and fluorescence observations with IOS N-PLAN objectives.

The HBO fluorescence illuminator provides an outstanding flexibility of use, standing the blue and green filter sets (supplied as standard) for Auramine, FITC, GFP and YFP (with blue filter set) plus Rhodamine, Texas Red and TRITC (with the green one), yet giving the possibility to combine any other specific filter sets for future upgrade. Transmitted light through the exclusive **X-LED³** to ensure great-looking, rich and high-quality specimen view.

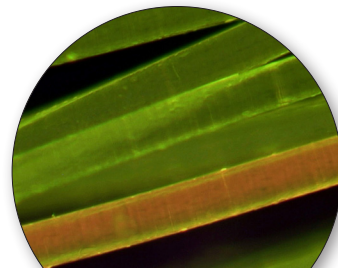

10x - Blue excitation

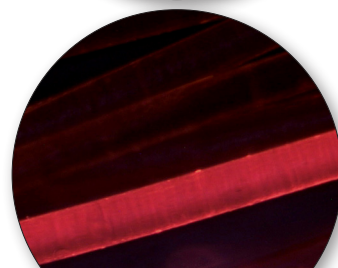

10x - Green excitation

Standard filterset

Name	Excitation filter (nm)	Dichroic mirror cut-off (nm)	Emission filter (nm)
B Blue	460 – 490	505	515LP
G Green	510 – 550	570	575LP



Part	Description
Observation mode:	Brightfield, HBO fluorescence.
Epi-illumination and filters:	HBO 100 W high pressure mercury lamp. 3-position filter holder; blue and green included.
Head:	Trinocular (fixed 50/50), 30° inclined, 360° rotating.
Interpupillary distance:	Adjustable between 48 and 75 mm.
Dioptric adjustment:	On the left eyepiece tube.
Eyepieces:	WF10x/20 mm, high eye-point and secured by screw.
Nosepiece:	Quintuple revolving nosepiece, rotation on ball bearings.
Objectives:	IOS N-PLAN 4x/0.10 IOS N-PLAN 10x/0.25 IOS N-PLAN 20x/0.40 IOS N-PLAN 40x/0.65 IOS N-PLAN 100x/1.25 (Oil/Water) All with anti-fungus treatment.

Part	Description
Specimen stage:	Double layer rackless mechanical stage, 233x147 mm, 78x54 mm X-Y range.
Focusing:	Coaxial coarse (adjustable tension) and fine focusing mechanism with limit stop to prevent the contact between objective and specimen.
Condenser:	Abbe N.A. 1.25, with objective-coded iris diaphragm, focusable and centerable.
Transmitted illumination (Fixed Koehler type):	X-LED ³ with white 3.6 W LED (6,300K) with brightness control. Multi-plug 100-240Vac/6Vdc external power supply.

B-383LD - LED Fluorescence Microscope

Entry-level laboratory upright microscope for brightfield and fluorescence observations with IOS N-PLAN objectives. The extremely powerful LED fluorescence illuminator is combined with blue excitation filter set for the visualization of the following fluorochromes: Acridine Yellow, Acridine Orange, Auramine, DiO, DTAF, FITC, GFP, YFP, etc. LED fluorescence ensures unparalleled convenience eliminating warm-up/cool-down times and all the inconveniences related lamp replacement and adjustment. Transmitted light through the exclusive **X-LED³** to ensure great-looking, rich and high-quality specimen view.

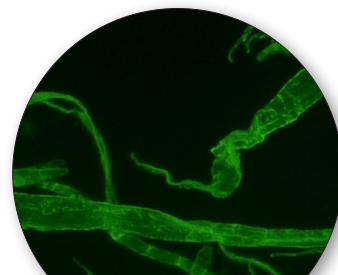

4x

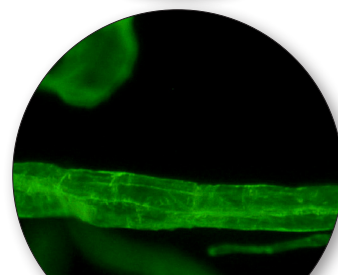

10x

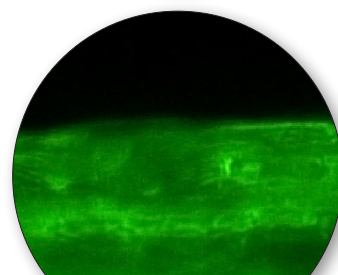

40x

Standard filterset

Name	Excitation filter (nm)	Dichroic mirror cut-off (nm)	Emission filter (nm)
B Blue	460 – 490	505	515LP

Part	Description
Observation mode:	Brightfield, LED fluorescence.
Epi-illumination and filter:	High-power blue LED with brightness control. 3-position filter holder; blue included.
Head:	Trinocular (fixed 50/50), 30° inclined, 360° rotating.
Interpupillary distance:	Adjustable between 48 and 75 mm.
Dioptric adjustment:	On the left eyepiece tube.
Eyepieces:	WF10x/20 mm, high eye-point and secured by screw.
Nosepiece:	Quintuple revolving nosepiece, rotation on ball bearings.
Objectives:	IOS N-PLAN 4x/0.10 IOS N-PLAN 10x/0.25 IOS N-PLAN 40x/0.65 IOS N-PLAN 100x/1.25 (Oil/Water) All with anti-fungus treatment.

Part	Description
Specimen stage:	Double layer rackless mechanical stage, 233x147 mm, 78x54 mm X-Y range.
Focusing:	Coaxial coarse (adjustable tension) and fine focusing mechanism with limit stop to prevent the contact between objective and specimen.
Condenser:	Abbe N.A. 1.25, with objective-coded iris diaphragm, focusable and centerable.
Transmitted illumination (Fixed Koehler type):	X-LED ³ with white 3.6 W LED (6,300K) with brightness control. Multi-plug 100-240Vac/6Vdc external power supply.

B-383POL - Polarizing Microscope

Upright microscope for brightfield and polarizing light observations with strain-free IOS N-PLAN POL objectives. Complete of polarizer and analyzer filters, Bertrand lens for conoscopic observation, compensator plates and high-precision rotatable stages. It comes with the exclusive **X-LED³** illumination system to deliver bright and clear images, along with all the accessories to perform accurate polarization analysis in biology and materials science.

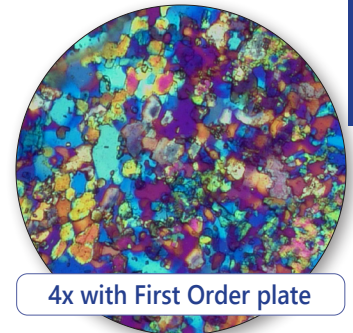

4x with First Order plate

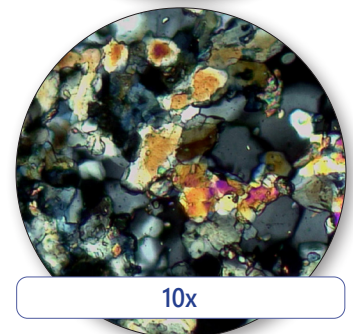

10x



10x with First Order plate

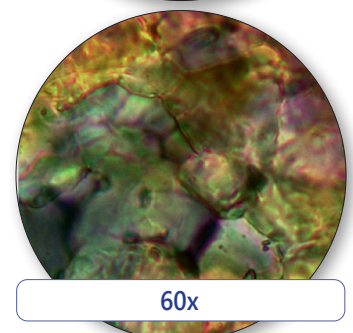

60x

Part	Description
Observation mode:	Brightfield, transmitted polarized light and conoscopy.
Bertrand lens and polarizing attachment:	Swing-out type with centering mechanism for observation in conoscopy/orthoscopy. Rotatable analyzer from 0° to 90° with graduated scale. Tint plates: 1° order red (λ); $\lambda/4$; Quartz wedge.
Head:	Trinocular (fixed 50/50), 30° inclined, 360° rotating.
Interpupillary distance:	Adjustable between 48 and 75 mm.
Dioptric adjustment:	On the left eyepiece tube.
Eyepieces:	WF10x/20 mm, high eye-point and secured by screw. One with crosshair.
Nosepiece:	Quadruple revolving nosepiece, rotation on ball bearings. Centering system for each objective.

Part	Description
Objectives (strain-free):	IOS N-PLAN POL 4x/0.10 IOS N-PLAN POL 10x/0.25 IOS N-PLAN POL 40x/0.65 IOS N-PLAN POL 60x/0.80 All with anti-fungus treatment.
Specimen stage:	Rotatable stage with locking mechanism. Vernier scale with accuracy 0.1 mm. Diameter 160 mm. Specimen slide clamps.
Focusing:	Coaxial coarse (adjustable tension) and fine focusing mechanism with limit stop to prevent the contact between objective and specimen.
Condenser:	Abbe N.A. 1.25, with objective-coded iris diaphragm, focusable and centerable. With rotating polarizing filter.
Transmitted illumination (Fixed Koehler type):	X-LED ³ with white 3.6 W LED (6.300 K) with brightness control. Multi-plug 100-240Vac/6Vdc external power supply.

B-383MET - Metallurgical Microscope

Brightfield upright microscope with IOS W-PLAN MET objectives and metallurgical attachment combining the exclusive **X-LED³** lighting source both for incident and transmitted illumination. The NCG (no cover glass) objectives are especially designed for microscopy use without a cover slip ideal for metallographic samples and other opaque specimens.

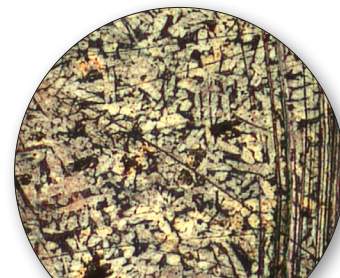

5x

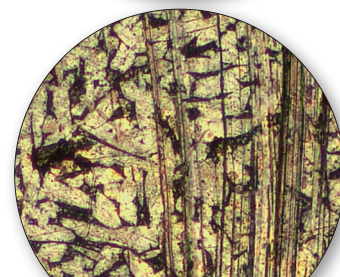

10x

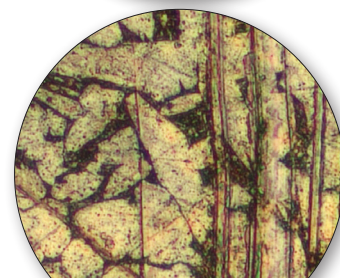

20x

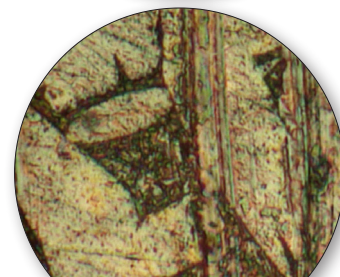

50x

Part	Description
Observation mode:	Brightfield, incident polarized light.
Epi-illumination and polarizing filters:	X-LED ³ with white 3.6 W LED (6.300 K) with brightness control. Field and aperture diaphragms, polarizer & analyzer filters.
Head:	Trinocular (fixed 50/50), 30° inclined, 360° rotating.
Interpupillary distance:	Adjustable between 48 and 75 mm.
Dioptric adjustment:	On the left eyepiece tube.
Eyepieces:	WF10x/20 mm, high eye-point and secured by screw.
Nosepiece:	Quintuple revolving nosepiece, rotation on ball bearings.

Part	Description
Objectives (strain-free):	IOS W-PLAN MET 5x/0.12 IOS W-PLAN MET 10x/0.25 IOS W-PLAN MET 20x/0.40 IOS W-PLAN MET 50x/0.75 All with anti-fungus treatment.
Specimen stage:	Double layer rackless mechanical stage, 233x147 mm, 78x54 mm X-Y range. With tempered glass plate.
Focusing:	Coaxial coarse (adjustable tension) and fine focusing mechanism with limit stop to prevent the contact between objective and specimen.
Condenser:	Abbe N.A. 1.25, with objective-coded iris diaphragm, focusable and centerable.
Transmitted illumination (Fixed Koehler type):	X-LED ³ with white 3.6 W LED (6.300 K) with brightness control. Multi-plug 100-240Vac/6Vdc external power supply.

B-380 Series - Comparison chart

Model	Head	Eyepieces	Nosepiece	Objectives	Stage	Focusing	Condenser	Illumination
B-382PL-ALC	Binocular, 30° inclined	WF 10x/20	Quintuple, reversed	N-PLAN 4x, 10x, 40x, 100x (oil/water)	Rackless double layer, 150x139mm, moving range 75x33mm	Coaxial coarse and fine, limit stop, adjustable tension	Abbe N.A. 1.25, iris diaphragm, focusable and centrable	3.6 W X-LED ³ , brightness control, ALC control. Fixed Koehler
B-383PL	Trinocular, 30° inclined, 360° rotating	WF 10x/20	Quintuple, reversed	N-PLAN 4x, 10x, 40x, 100x (oil/water)	Rackless double layer, 150x139mm, moving range 75x33mm	Coaxial coarse and fine, limit stop, adjustable tension	Abbe N.A. 1.25, iris diaphragm, focusable and centrable	3.6 W X-LED ³ , brightness control. Fixed Koehler
B-382PLi-ALC	Binocular, 30° inclined	WF 10x/20	Quintuple, reversed	IOS N-PLAN 4x, 10x, 40x, 100x (oil/water)	Rackless double layer, 233x147mm, moving range 78x54 mm	Coaxial coarse and fine, limit stop, adjustable tension	Abbe N.A. 1.25, iris diaphragm, focusable and centrable	3.6 W X-LED ³ , brightness control, ALC control. Fixed Koehler
B-383PLi	Trinocular, 30° inclined, 360° rotating	WF 10x/20	Quintuple, reversed	IOS N-PLAN 4x, 10x, 40x, 100x (oil/water)	Rackless double layer, 233x147mm, moving range 78x54 mm	Coaxial coarse and fine, limit stop, adjustable tension	Abbe N.A. 1.25, iris diaphragm, focusable and centrable	3.6 W X-LED ³ , brightness control. Fixed Koehler
B-382PH-ALC	Binocular, 30° inclined	WF 10x/20	Quintuple, reversed	W-PLAN 4x, 10xPH, 40xPH, 100xPH (oil)	Rackless double layer, 150x139mm, moving range 75x33mm	Coaxial coarse and fine, limit stop, adjustable tension	Phase condenser (10x/20x, 40x, 100x) with darkfield (dry) and brightfield	3.6 W X-LED ³ , brightness control, ALC control. Fixed Koehler
B-383PH	Trinocular, 30° inclined, 360° rotating	WF 10x/20	Quintuple, reversed	W-PLAN 4x, 10xPH, 40xPH, 100xPH (oil)	Rackless double layer, 150x139mm, moving range 75x33mm	Coaxial coarse and fine, limit stop, adjustable tension	Phase condenser (10x/20x, 40x, 100x) with darkfield (dry) and brightfield	3.6 W X-LED ³ , brightness control. Fixed Koehler
B-382PHi-ALC	Binocular, 30° inclined	WF 10x/20	Quintuple, reversed	IOS W-PLAN 10xPH, 20xPH, 40xPH, 100xPH (oil)	Rackless double layer, 233x147mm, moving range 78x54 mm	Coaxial coarse and fine, limit stop, adjustable tension	Phase condenser (10x/20x, 40x, 100x) with darkfield (dry) and brightfield	3.6 W X-LED ³ , brightness control, ALC control. Fixed Koehler
B-383PHi	Trinocular, 30° inclined, 360° rotating	WF 10x/20	Quintuple, reversed	IOS W-PLAN 10xPH, 20xPH, 40xPH, 100xPH (oil)	Rackless double layer, 233x147mm, moving range 78x54 mm	Coaxial coarse and fine, limit stop, adjustable tension	Phase condenser (10x/20x, 40x, 100x) with darkfield (dry) and brightfield	3.6 W X-LED ³ , brightness control. Fixed Koehler
B-383DK	Trinocular, 30° inclined, 360° rotating	WF 10x/20	Quintuple, reversed	N-PLAN 4x, 10x, 40x, W-PLAN 100x (oil, with iris diaphragm)	Rackless double layer, 150x139mm, moving range 75x33mm	Coaxial coarse and fine, limit stop, adjustable tension	Abbe N.A. 1.25, iris diaphragm, focusable and centrable. Additional darkfield condenser, N.A. 1.36, built-in X-LED ³	3.6 W X-LED ³ , brightness control. Fixed Koehler
B-383FL	Trinocular, 30° inclined, 360° rotating	WF 10x/20	Quintuple, reversed	IOS N-PLAN 4x, 10x, 20x, 40x, 100x (oil/water)	Rackless double layer, 233x147mm, moving range 78x54 mm	Coaxial coarse and fine, limit stop, adjustable tension	Abbe N.A. 1.25, iris diaphragm, focusable and centrable	Transmitted: 3.6 W X-LED ³ , brightness control. Fixed Koehler Incident: HBO 100 W high-pressure mercury bulb
B-383LD	Trinocular, 30° inclined, 360° rotating	WF 10x/20	Quintuple, reversed	IOS N-PLAN 4x, 10x, 40x, 100x (oil/water)	Rackless double layer, 233x147mm, moving range 78x54 mm	Coaxial coarse and fine, limit stop, adjustable tension	Abbe N.A. 1.25, iris diaphragm, focusable and centrable	Transmitted: 3.6 W X-LED ³ , brightness control. Fixed Koehler Incident: High-power blue LED
B-383POL	Trinocular, 30° inclined, 360° rotating	WF 10x/20 (one with crosshair reticle)	Quadruple, reversed	Strain-free IOS N-PLAN POL 4x, 10x, 40x, 60x	Round, 360° rotating, 160mm diameter, with sample clips and stop knob	Coaxial coarse and fine, limit stop, adjustable tension	Abbe N.A. 1.25, iris diaphragm, focusable and centrable. With rotating polarizer	3.6 W X-LED ³ , brightness control. Fixed Koehler
B-383MET	Trinocular, 30° inclined, 360° rotating	WF 10x/20	Quintuple, reversed	IOS W-PLAN MET 5x, 10x, 20x, 50x	Rackless double layer, 233x147mm, moving range 78x54 mm	Coaxial coarse and fine, limit stop, adjustable tension	Abbe N.A. 1.25, iris diaphragm, focusable and centrable	Transmitted and incident: 3.6 W X-LED ³ , brightness control. Fixed Koehler

2 B-380 Series - Accessories

Eyecups & Eyepieces

- M-001 Huygens 5x eyepiece
- M-008.1 WF10x/20 eyepiece, high eyepoint, with pointer, rubber cup
- M-160 EW10x/20 eyepiece, high eyepoint, with rubber cup
- M-161 EW15x/16 eyepiece, with rubber cup
- M-162 WF20x/10 eyepiece
- M-163 EW10x/20 micrometric eyepiece, high eyepoint, with rubber cup

Objectives

N-PLAN

- M-164 N-PLAN objective 4x/0.10
- M-165 N-PLAN objective 10x/0.25
- M-166 N-PLAN objective 20x/0.40
- M-167 N-PLAN objective 40x/0.65
- M-168 N-PLAN objective 60x/0.85
- M-169 N-PLAN objective 100x/1.25 (oil)

IOS N-PLAN

- M-144 IOS N-PLAN objective 4x/0.10
- M-145 IOS N-PLAN objective 10x/0.25
- M-146 IOS N-PLAN objective 20x/0.40
- M-147 IOS N-PLAN objective 40x/0.65
- M-149 IOS N-PLAN objective 60x/0.80
- M-148 IOS N-PLAN objective 100x/1.25 (oil)
- M-144P IOS N-PLAN POL objective 4x/0.10
- M-145P IOS N-PLAN POL objective 10x/0.25
- M-146P IOS N-PLAN POL objective 20x/0.40
- M-147P IOS N-PLAN POL objective 40x/0.65
- M-149P IOS N-PLAN POL objective 60x/0.80
- M-148P IOS N-PLAN POL objective 100x/1.25 (oil)

W-PLAN

- M-059 W-PLAN objective 100x/1.25OI - (oil) objective with iris for DF
- M-170 W-PLAN PH objective 10x/0.25
- M-171 W-PLAN PH objective 20x/0.40
- M-172 W-PLAN PH objective 40x/0.65
- M-182 W-PLAN PH objective 100x/1.25 (oil)

IOS W-PLAN

- M-634.1 IOS W-PLAN objective 50x/0.95 (oil)
- M-336 IOS W-PLAN MET objective 5x/0.12
- M-338 IOS W-PLAN MET objective 10x/0.25
- M-339 IOS W-PLAN MET objective 20x/0.40
- M-335 IOS W-PLAN MET objective 50x/0.75
- M-698.2 IOS W-PLAN MET objective 100x/0.80 (dry)
- M-1120.N IOS W-PLAN PH objective 10x/0.25
- M-1121.N IOS W-PLAN PH objective 20x/0.40
- M-1122.N IOS W-PLAN PH objective 40x/0.65
- M-1123.N IOS W-PLAN PH objective 100x/1.25 (oil)



M-181 - PH set - 10x, 20x, 40x, 100x IOS W-PLAN PH obj. & BF/DF/PH condenser



M-185 - Darkfield condenser for dry objectives



M-179 - PH set - 10x, 40x, 100x W-PLAN PH obj. & BF/DF/PH condenser

B-380 Series - Accessories

Stages

M-175	Rotating stage for polarising set (for 150x139mm rackless stage)
M-175.1	Rotating stage for polarising set (for 233x147mm rackless stage)
M-635	Heating stage (on newly purchased microscopes, for 233x147mm stage), multiplug
M-666.290	Heating stage (on newly purchased microscopes, for 150x139mm stage), multiplug

Condensers & Filters

M-174.1	Polarising set (filters only) (except for B-383POL)
M-179	PH set - 10x, 40x, 100x W-PLAN PH obj. & BF/DF/PH condenser
M-181	PH set - 10x, 20x, 40x, 100x IOS W-PLAN PH obj. & BF/DF/PH condenser
M-185	Darkfield condenser for dry objectives
M-975.1	Ring with blue filter, 45mm diameter
M-977.1	Ring with green filter, 45mm diameter
M-979.1	Ring with yellow filter, 45mm diameter
M-989.1	Ring with frosted glass filter, 45mm diameter

Camera Adapters

M-115	0.35x C-Mount projection lens
M-114	0.5x C-Mount projection lens
M-118	0.75x C-Mount projection lens
M-173	C-Mount projection lens for APS-C/full frame reflex cameras (trino)
M-620	0.35x focusable C-Mount adapter (biological microscopes)
M-620.1	0.5x focusable C-Mount adapter (biological microscopes)
M-620.2	0.65x focusable C-Mount adapter (biological microscopes)
M-620.3	1x focusable C-Mount adapter (biological & stereomicroscopes)
M-699	Universal adapter for C-Mount projection lens (trino)

Miscellaneous

15008	Immersion oil, 10ml
15009	Immersion oil, 100ml
15104	Cleaning kit
DC-002	Plastic dust cover, medium, 490(l)x490(h) mm (except for B-383POL, B-383MET, B-383LD1, B-383LD2 and B-383FL)
DC-003	TNT dust cover, medium, 600(l)x550(h) mm (only for B-383POL, B-383MET, B-383LD1, B-383LD2 and B-383FL)
M-005	Micrometric slide, 26x76mm, with 2 scales (1mm/100 & 10mm/100)
M-069	Solar charger
M-151	HBO 100W high-pressure mercury bulb for fluorescence (only for B-383FL)
M-151.1	HBO 100W high-pressure mercury bulb for fluorescence (OSRAM) (only for B-383FL)
M-156	Koehler field diaphragm (on newly purchased microscopes) (except for B-383POL)
M-1380	Centering telescope, 23mm diameter
VP-380	IQ/OQ/PQ manual for B-380 series
AB-020	Antibacterial surface treatment, only for newly purchased microscope



How to connect the cameras to our microscopes.

Please refer to the Adapter reference list on Digital section.

15104 - Cleaning kit

It cleans glass quickly and effectively, without leaving residue or odor. Ideal for precision lens or prism cleaning.



M-069 - Solar charger

Included battery: rechargeable – Lithium-Poly.
Capacity: 2500 mAh. - Output voltage: 5 Vdc.
Autonomy: over 6 hours at medium intensity (X-LED³).
Charging models: with solar panel (12h), with external USB power supply (2.5h)



v 6.6.0 - OPTIKA reserves the right to make corrections, modifications, enhancements, improvements and other changes to its products at any time without notice.

Headquarters and Manufacturing Facilities

OPTIKA® S.r.l. Via Rigla, 30 - 24010 Ponteranica (BG) - ITALY - Tel.: +39 035.571.392 - info@optikamicroscopes.com

Optika Sales branches

OPTIKA® Spain spain@optikamicroscopes.com
OPTIKA® China china@optikamicroscopes.com
OPTIKA® India india@optikamicroscopes.com

OPTIKA® USA usa@optikamicroscopes.com
OPTIKA® Central America america@optikamicroscopes.com

B-510 Series



Advanced Routine Lab Upright Microscopes

Born To Be Professional

HIGH-GRADE CONFIGURATIONS FOR PROFESSIONALS

- » Wide range to fulfill specific lab requirements
- » Valuable solutions for life and material sciences
- » Compliant with several observation methods

AN AFFORDABLE PARTNER WITH HIGH-END FEATURES

- » IOS W-PLAN objectives for flat images on 22 mm FN
- » Full Koehler illumination for enhanced images
- » Rounded edge, rackless stage to prevent scratches



Optically Impressive

MAINTAINING GOOD EYESIGHT

- » 10x/22 eyepieces for large specimen view
- » Comfortable rubber cup to get rid of annoying external light
- » High eye-point for glasses wearers, dioptic adjustment (left eyepiece)

B-510 & IOS W-PLAN: THE PERFECT COMBINATION

- » IOS Infinity corrected optical system
- » Full planarity optics on 22 mm (W-PLAN) according to ISO 19012-1
- » High-grade Semi-Apo lens available ideal for fluorescence



An Extensive Range of Different Configurations

THE MODELS FOR ASBESTOS TESTING IN ENVIRONMENTAL MONITORING

- » B-510ASB measures fiber concentrations in air and includes 40xPH lens and 12.5x Walton & Beckett eyepieces
- » B-510POL & B-510POL-I for bulk/fiber class identification

B-510DK - THE DEDICATED MODEL FOR FRESH BLOOD ANALYSIS

- » Exclusive X-LED³ darkfield cardioid condenser with high N.A. 1.36 and the new IOS W-PLAN 100x oil iris objective
- » Brightfield condenser also supplied

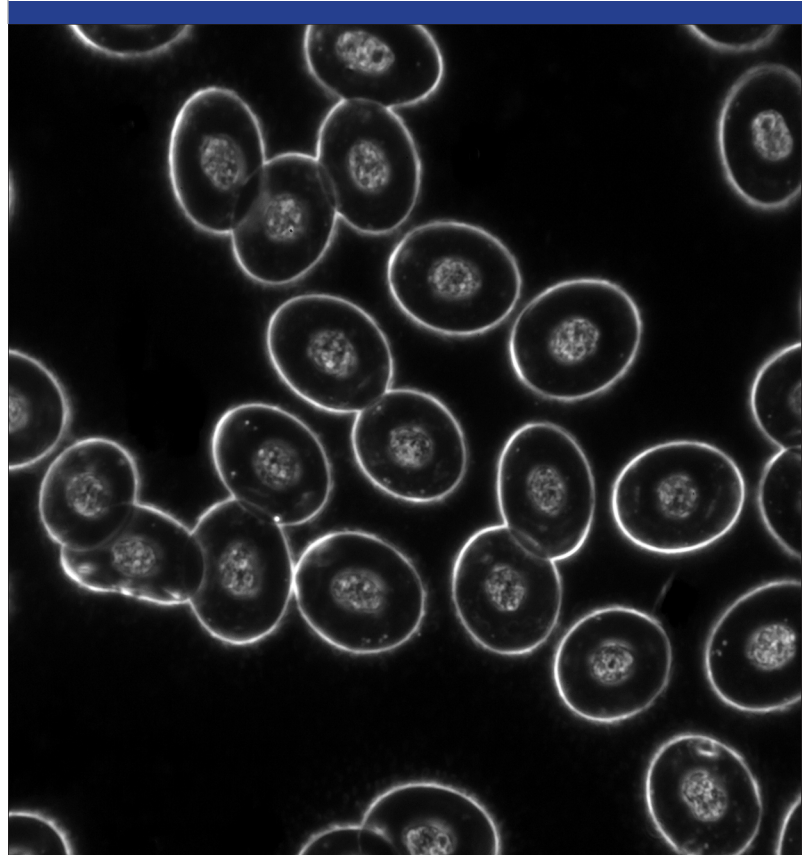
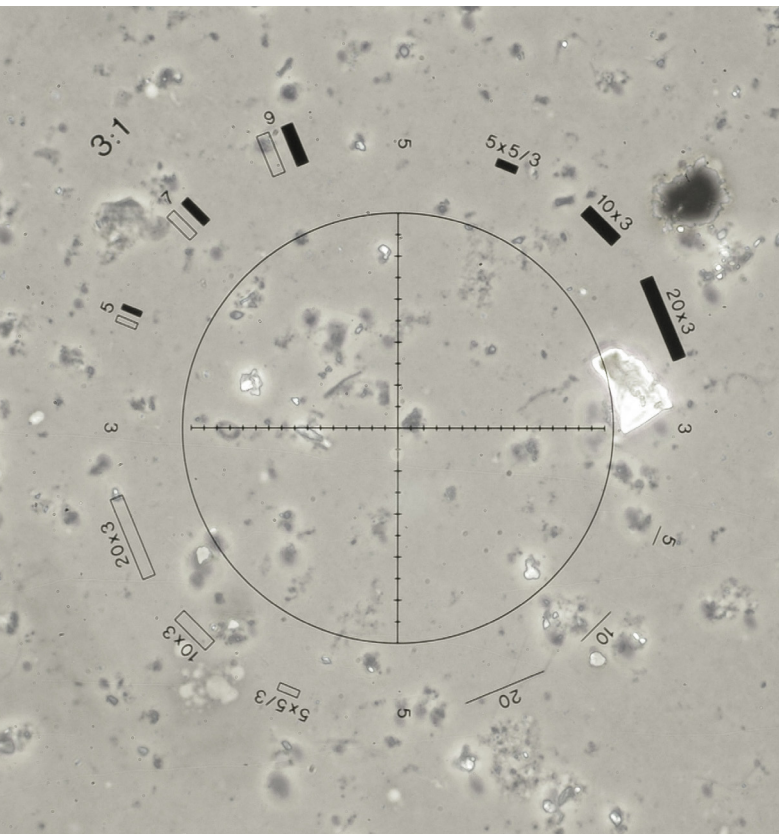

Multiple Observation Methods

BRIGHTFIELD

METALLOGRAPHY

DARKFIELD

POLARIZATION

FLUORESCENCE

PHASE CONTRAST

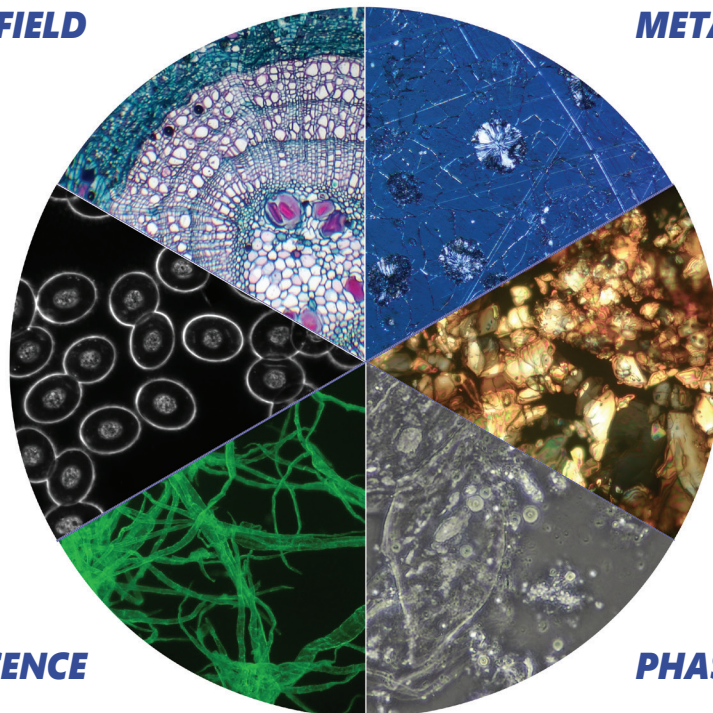

Many Specimens, Many Observers - Intense Productivity

2

INCREASE YOUR SAMPLE THROUGHPUT

- » Large, resistant stage to easily and quickly process 2 samples
- » Ergonomic design and controls for extended operation
- » Convenient handle for easy transportation

DISCUSSION BRIDGES FOR SIMULTANEOUS OBSERVATIONS AND TEACHING

- » RGB pointer with brightness adjustment for the main observer
- » Face-to-face attachment with 1 extra viewing head, 20mm FN
- » Side attachment with 1, 2 & 4 extra viewing heads, 20mm FN

Laboratory



Multi-Head Discussion Microscopes

With discussion bridges, up to 5 people/colleagues can observe the same image on B-510. Ideal for teaching and training students, especially in the medical field. The main observer and additional viewers will benefit of an extremely homogeneous light conditions, with a three-colour pointer with settable intensity to highlight points of interest.

X-LED³ - Only Available at OPTIKA

STATE-OF-THE-ART ILLUMINATION SYSTEM

- » Uncomparable light intensity, exclusive lens & collector design
- » Constant pure-white color temperature at all intensity levels
- » Unmatched color fidelity, uniformity and brightness

CUT ELECTRICITY BILLS BY 90%

- » Money & energy saving, only 3.6 W
- » More efficient brightness than a 50 W halogen lamp
- » LED long lifetime (65,000 hours = 22 years at 8 hours/day usage)

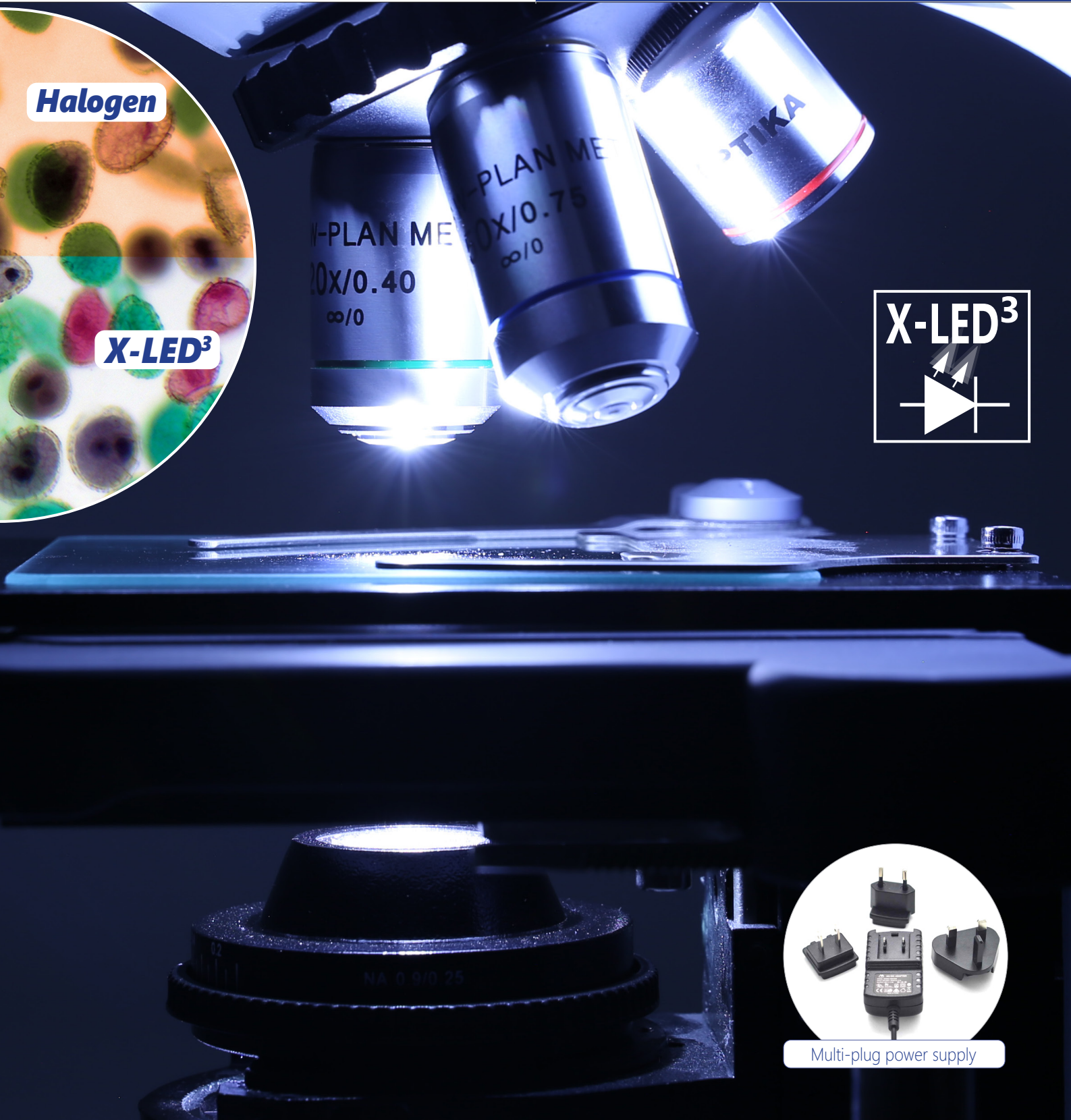

Halogen

X-LED³

X-LED³

Multi-plug power supply

Go Digital - Vivid Colors & Contrast For Stunning Images

2

STAY CONNECTED WITH YOUR SPECIMEN, EASILY

- » Trinocular port to be always updated with the latest technology cameras, even in the future
- » Wide range of cameras matching all the needs, including the more specific ones
- » Modern C-mount focusable professional adapters for all kinds of cameras

PROFESSIONAL IMAGE ANALYSIS

- » Multi-language software for live-view, picture and video in different file formats
- » Advanced functions for pictures processing (EDF, stitching, multi-fluorescence combine)
- » Powerful tools to perform measurements and generate custom reports

Laboratory



B-510 Series

OPTIKA B-510 Series meets a wide variety of analysis applications, thanks to the comprehensive range of microscope models equipped with enhanced and impressive optics, a wide field of view of 22 mm, the state-of-the-art, exclusive X-LED lighting source and Koehler illuminator to produce high sample contrast and homogeneous bright light.

A Perfect Downgrading of Top-Level Series

Many components of B-510 come from the B-810/1000 Series, the top-level in OPTIKA range, to ensure the state-of-the-art performance and at the same time an incredible level of reliability and durability. Its excellent quality/price ratio is achieved through an intelligent rationalization of production costs and choice of materials.

X-LED³ Exclusive Lighting Source

Special technology able to double the light intensity for incomparable performance, ensuring constant pure-white colour temperature (6,300K colour temperature).

Relevant money and energy saving thanks to the incredibly low energy consumptions which allows you to cut the electricity bills by 90%!

The electric consumption (3.6 W only) proves the high efficiency of this system: incredibly high light intensity combined with low consumption.

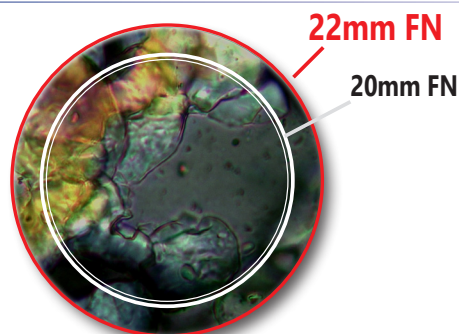

Large Specimen View (22 mm Field Number)

The **F.O.V.** (field of view) is based on a comfortable diameter of 22 mm.

This means that an extra wide area of the sample can be inspected and allows a natural and easy view, particularly needed in a laboratory environment.

Safe And Convenient Operations

Rounded edge rackless stage has been designed with a belt-driven mechanism that allows a smooth movement without any protruding part.

This design gives you a more compact solution and lowers any risk of injury after accidentally hitting the rack with your hands.

The electric consumption (3.6 W only) proves the high efficiency of this system: incredibly high light intensity combined with low consumption.



OPTIKA
MICROSCOPES
ITALY

Advanced Routine Lab Upright Microscopes

Universal Condenser For Brightfield, Darkfield & Phase

OPTIKA B-510 phase contrast microscopes are equipped with a 5-position dedicated rotating condenser for brightfield (standard use), phase contrast (10x/20x, 40x and 100x phase diaphragms), and a darkfield position for dry objectives.



Exclusive X-LED³ Darkfield Condenser

The special condenser with integrated, exclusive X-LED³ illuminator replaces any other external and expensive lighting source required for these applications and is ideal for great-looking, rich and high-quality specimen view.

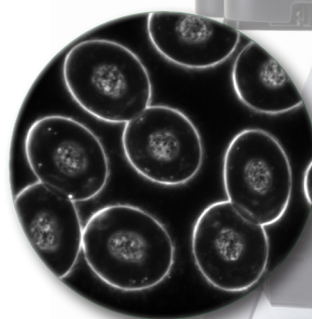

In fluorescence we can offer several options.

According to your application and to the fluorochromes you are using, we can help you to identify the best light source.

Traditional, HBO Fluorescence

- » The most used and diffused method, worldwide
- » Wide spectrum range for future upgrades

Innovative, LED Fluorescence

- » Recommended for routine applications
- » Cost-effective, money saving technology
 - » Ready for immediate operation
 - » Eliminate warm-up/cool-down times
 - » Forget lamp replacement & centering



B-510BF / B-510ERGO - Brightfield Microscope

Advanced routine laboratory microscope for brightfield observations with IOS W-PLAN objectives and rackless stage. The high-efficiency **X-LED³** makes it reliable for all transmitted light observations for great-looking, rich and high-quality view.



B-510BF



B-510ERGO

Part	Description
Observation mode:	Brightfield.
Head:	B-510BF: Trinocular (fixed 50/50), 30° inclined, 360° rotating. B-510ERGO: Binocular ergonomical head, 30°- 60° inclined, 360° rotating.
Interpupillary distance:	Adjustable between 50 and 75 mm.
Dioptric adjustment:	On the left eyepiece tube.
Eyepieces:	WF10x/22 mm, high eye-point and with rubber cups.
Nosepiece:	Quintuple revolving nosepiece, rotation on ball bearings.
Objectives:	IOS W-PLAN 4x/0.10 IOS W-PLAN 10x/0.25 IOS W-PLAN 40x/0.65 IOS W-PLAN 100x/1.25 (Oil) All with anti-fungus treatment.

Part	Description
Specimen stage:	Double layer rackless mechanical stage, 233x147 mm, 78x54 mm X-Y range.
Focusing:	Coaxial coarse (adjustable tension) and fine focusing mechanism with limit stop to prevent the contact between objective and specimen.
Condenser:	Swing-out N.A. 0.2/0.9, with iris diaphragm, focusable and centerable.
Transmitted illumination (Full Koehler type):	X-LED ³ with white 3.6 W LED (6,300K) with brightness control. Multi-plug 100-240Vac/6Vdc external power supply.

B-510PH - Phase Contrast Microscope

Advanced routine laboratory microscope for brightfield, darkfield and phase contrast observations with IOS W-PLAN PH objectives and rackless stage. Especially dedicated to phase contrast observation, the microscope ensures a high image sharpness even with complex specimens. The high-efficiency **X-LED³** makes it reliable for all transmitted light observations.

- 22
-
-
-
-
-
-
-
-

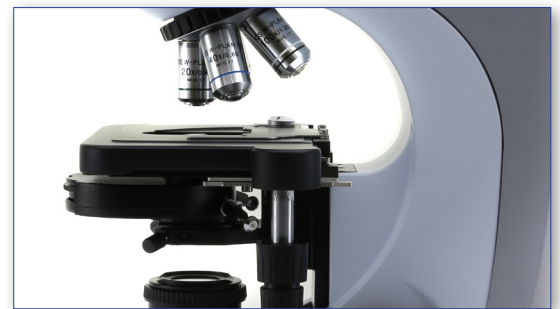
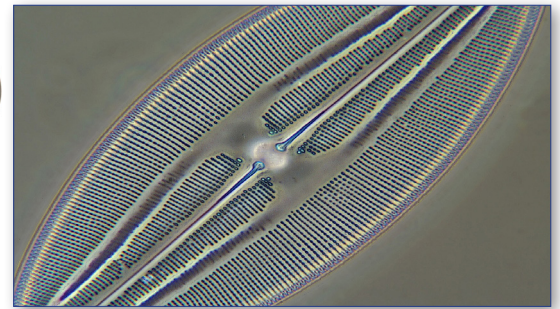

Part	Description
Observation mode:	Brightfield, phase contrast and darkfield (dry).
Head:	Trinocular (fixed 50/50), 30° inclined, 360° rotating.
Interpupillary distance:	Adjustable between 50 and 75 mm.
Dioptric adjustment:	On the left eyepiece tube.
Eyepieces:	WF10x/22 mm, high eye-point and with rubber cups.
Nosepiece:	Quintuple revolving nosepiece, rotation on ball bearings.
Objectives:	IOS W-PLAN PH 10x/0.25 IOS W-PLAN PH 20x/0.40 IOS W-PLAN PH 40x/0.65 IOS W-PLAN PH 100x/1.25 (Oil) All with anti-fungus treatment.

Part	Description
Specimen stage:	Double layer rackless mechanical stage, 233x147 mm, 78x54 mm X-Y range.
Focusing:	Coaxial coarse (adjustable tension) and fine focusing mechanism with limit stop to prevent the contact between objective and specimen.
Condenser:	Phase condenser (10x/20x, 40x, 100x) with darkfield (dry) and brightfield.
Transmitted illumination (Full Koehler type):	X-LED ³ with white 3.6 W LED (6,300K) with brightness control. Multi-plug 100-240Vac/6Vdc external power supply.

B-510ASB - Asbestos Analysis Microscope

Advanced routine laboratory microscope for brightfield and phase contrast observations with IOS W-PLAN objectives and rackless stage. Ideal for Asbestos analysis in accordance to international rules with 12.5x eyepieces and Walton & Becket graticule to perform perfect asbestos fibers analysis at a glance. The high-efficiency **X-LED³** makes it reliable for all transmitted light observations.

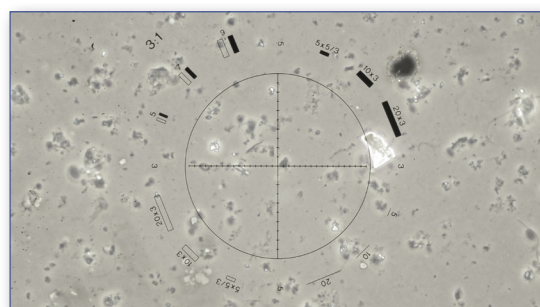

Part	Description
Observation mode:	Brightfield, phase contrast.
Head:	Trinocular (fixed 50/50), 30° inclined, 360° rotating.
Interpupillary distance:	Adjustable between 50 and 75 mm.
Dioptric adjustment:	On the left eyepiece tube.
Eyepieces:	WF10x/22 mm, high eye-point and WF12.5x/15 mm with dioptric adjustment, one with Walton & Beckett graticule.
Nosepiece:	Quintuple revolving nosepiece, rotation on ball bearings.
Objectives:	IOS W-PLAN 4x/0.10 IOS W-PLAN 10x/0.25 IOS W-PLAN PH 40x/0.65 IOS W-PLAN 100x/1.25 (Oil) All with anti-fungus treatment.

Part	Description
Specimen stage:	Double layer rackless mechanical stage, 233x147 mm, 78x54 mm X-Y range.
Focusing:	Coaxial coarse (adjustable tension) and fine focusing mechanism with limit stop to prevent the contact between objective and specimen.
Condenser:	Abbe N.A. 1.25, with objective-coded iris diaphragm, focusable and centerable. With 40x phase contrast slider.
Transmitted illumination (Full Koehler type):	X-LED ³ with white 3.6 W LED (6,300K) with brightness control. Multi-plug 100-240Vac/6Vdc external power supply.

B-510DK - Immersion Darkfield Microscope

Advanced routine laboratory microscope for brightfield and darkfield observations with IOS W-PLAN objectives (including 100x with iris) and rackless stage for biology and especially darkfield fresh blood analysis and the exclusive **X-LED³** illumination system. The special condenser with integrated, exclusive X-LED³ illuminator replaces any other external and expensive lighting source required for these applications and is ideal for great-looking, rich and high-quality specimen view. Our immersion darkfield system provides the same result achieved by 150W external illuminators in combination with traditional cardioid darkfield condenser.

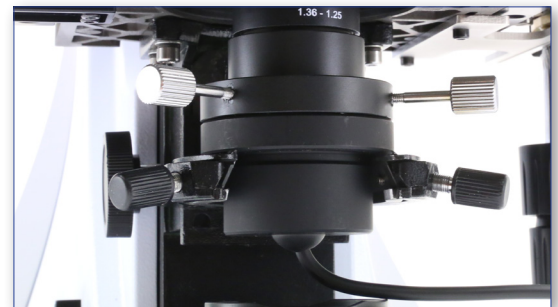
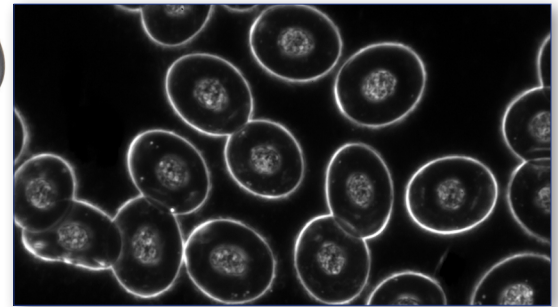

Part	Description
Observation mode:	Brightfield, oil immersion darkfield.
Head:	Trinocular (fixed 50/50), 30° inclined, 360° rotating.
Interpupillary distance:	Adjustable between 50 and 75 mm.
Dioptric adjustment:	On the left eyepiece tube.
Eyepieces:	WF10x/22 mm, high eye-point and with rubber cups.
Nosepiece:	Quintuple revolving nosepiece, rotation on ball bearings.
Objectives:	IOS W-PLAN 4x/0.10 IOS W-PLAN 10x/0.25 IOS W-PLAN 40x/0.65 IOS W-PLAN 100x/1.25 (oil) with iris All with anti-fungus treatment.

Part	Description
Specimen stage:	Double layer rackless mechanical stage, 233x147 mm, 78x54 mm X-Y range.
Focusing:	Coaxial coarse (adjustable tension) and fine focusing mechanism with limit stop to prevent the contact between objective and specimen.
Brightfield condenser:	Darkfield N.A. 1.36 (oil immersion) with built-in X-LED ³ .
Transmitted illumination (Full Koehler type):	X-LED ³ with white 3.6 W LED (6,300K) with brightness control. Multi-plug 100-240Vac/6Vdc external power supply.

B-510FL - HBO Fluorescence Microscope

Advanced routine laboratory microscope for brightfield and fluorescence observations with Semi-Apo IOS W-PLAN F objectives to enhance the visibility of the sample and increase the overall contrast. The **HBO fluorescence** illuminator provides an outstanding flexibility of use, standing the blue and green filter sets (supplied as standard) for Auramine, FITC, GFP and YFP (with blue filter set) plus Rhodamine, Texas Red and TRITC (with the green one), yet giving the possibility to combine any other specific filter sets for future upgrade. Transmitted light through the exclusive **X-LED³** to ensure great-looking, rich and high-quality specimen view.

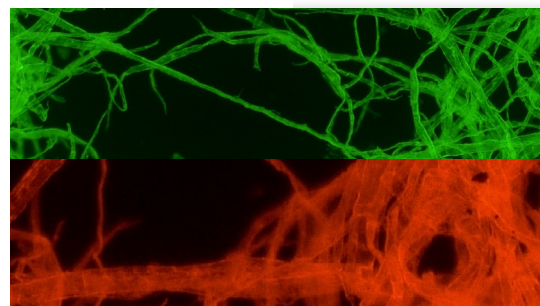

Standard filterset

Name	Excitation filter (nm)	Dichroic mirror cut-off (nm)	Emission filter (nm)
B Blue	460 - 490	505	515LP
G Green	510 - 550	570	575LP



Additional filterset (optional)

Name	Excitation filter (nm)	Dichroic mirror cut-off (nm)	Emission filter (nm)
V (Violet)	390 - 420	440	455LP
UV	325 - 375	415	435LP

Part	Description
Observation mode:	Brightfield, HBO fluorescence.
Epi-illumination and filter:	HBO 100 W high pressure mercury lamp. 4-position filter holder; blue & green included.
Head:	Trinocular (3-position 100/0, 50/50, 0/100), 30° inclined, 360° rotating.
Interpupillary distance:	Adjustable between 50 and 75 mm.
Dioptric adjustment:	On the left eyepiece tube.
Eyepieces:	WF10x/22 mm, high eye-point and with rubber cups.
Nosepiece:	Quintuple revolving nosepiece, rotation on ball bearings.
Objectives:	IOS W-PLAN F 4x/0.13 IOS W-PLAN F 10x/0.30 IOS W-PLAN F 20x/0.50 IOS W-PLAN F 40x/0.75 All with anti-fungus treatment.

Part	Description
Specimen stage:	Double layer rackless mechanical stage, 233x147 mm, 78x54 mm X-Y range.
Focusing:	Coaxial coarse (adjustable tension) and fine focusing mechanism with limit stop to prevent the contact between objective and specimen.
Condenser:	Swing-out N.A. 0.2/0.9, with iris diaphragm, focusable and centerable.
Transmitted illumination (Full Koehler type):	X-LED ³ with white 3.6 W LED (6,300K) with brightness control. Multi-plug 100-240Vac/6Vdc external power supply.

B-510LD4 - LED Fluorescence Microscope

Advanced routine fluorescence microscope for transmitted brightfield and fluorescence observations with IOS W-PLAN objectives. The extremely powerful LED Fluorescence Illuminators are combined with corresponding excitation filter sets for the visualization of most fluorochromes. LED fluorescence ensures unparalleled convenience eliminating warm-up/cool-down times and all the inconveniences related lamp replacement and adjustment. Transmitted light through the exclusive **X-LED³** to ensure great-looking, rich and high-quality specimen view.

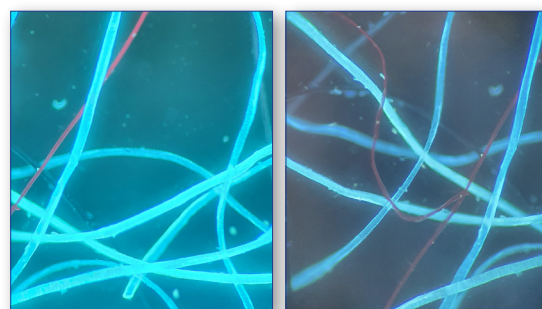
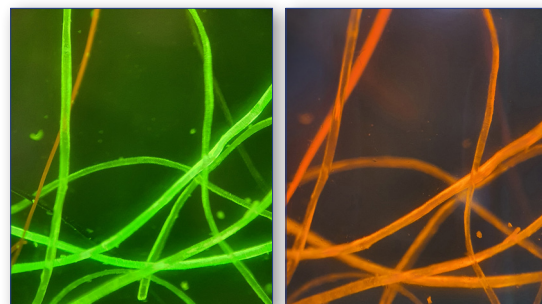

A new milestone achieved in Fluorescence Microscopy

- » Full-modular Fluorescence System
- » Interchangeable LED-Filtersets
- » 4 LED-Filtersets slots
- » 10% higher light intensity than HBO
- » 35% higher light intensity than Metal-Halide
- » Adjustable light intensity
- » The selection of filtersets automatically involves the switching on of the corresponding LEDs
- » Cost-effective, money saving technology
- » Ready for immediate operation
- » Eliminate warm-up/cool-down times
- » Forget lamp replacement & centering

Part	Description
Observation mode:	Brightfield, LED fluorescence.
Epi-illumination and filter:	High-power LED with brightness control. 4-position filter holder; none included.
Head:	Trinocular (3-position 100/0, 50/50, 0/100), 30° inclined, 360° rotating.
Interpupillary distance:	Adjustable between 50 and 75 mm.
Dioptric adjustment:	On the left eyepiece tube.
Eyepieces:	WF10x/22 mm, high eye-point and with rubber cups.
Nosepiece:	Quintuple revolving nosepiece, rotation on ball bearings.
Object.: B-510LD4:	IOS W-PLAN 4x/0.10 IOS W-PLAN 10x/0.25 IOS W-PLAN 40x/0.65 IOS W-PLAN 100x/1.25 (Oil)
B-510LD4-SA:	IOS W-PLAN F 4x/0.13 IOS W-PLAN F 10x/0.30 IOS W-PLAN F 40x/0.75 IOS W-PLAN F 100x/1.3 (Oil)
	All with anti-fungus treatment.

Part	Description
Specimen stage:	Double layer rackless mechanical stage, 233x147 mm, 78x54 mm X-Y range.
Focusing:	Coaxial coarse (adjustable tension) and fine focusing mechanism with limit stop to prevent the contact between objective and specimen.
Condenser:	Swing-out N.A. 0.2/0.9, with iris diaphragm, focusable and centerable.
Transmitted illumination (Full Koehler type):	X-LED ³ with white 3.6 W LED (6,300K) with brightness control. Multi-plug 100-240Vac/6Vdc external power supply.

B-510LD4 - LED Fluorescence Microscope

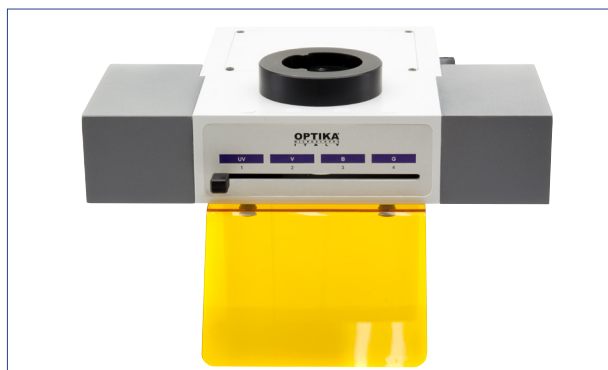

OPTIKA LED Fluorescence attachment is a revolutionary solution.

It consists of a 4-position selector for the use of 4 fluorescent illuminators, called LED Fluorescence Cubes.

Each Cube is composed of a filterset mounted on a filterblock and a high power LED with emission corresponding to the filters installed. In this way the selection of each filter controls the lighting up of the corresponding LED.

The microscope is supplied without any LED Fluorescence Cube. A selection of 9 types is available, as shown in the table below.

B-510LD4

Trinocular brightfield microscope, 1000x,
IOS W-PLAN objectives



B-510LD4-SA

Trinocular brightfield microscope, 1000x,
IOS W-PLAN F (Semi-Apo) objectives. **For UV Fluorescence**



M-1220 ... M-1228

LED Fluorescence Cubes (LED + Filterset)

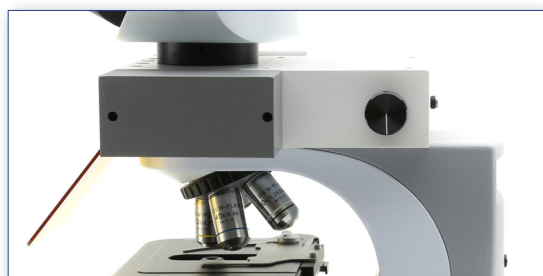
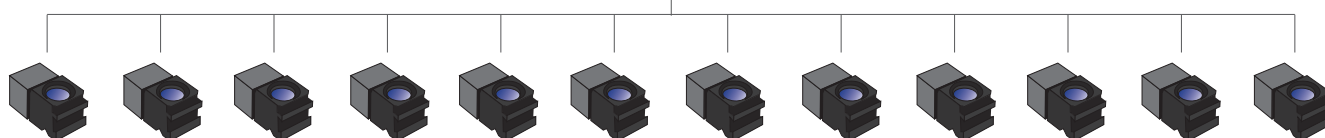

LED Fluorescence Cubes available (LED + Filterset)

Name	LED emission (nm)	Excitation filter (nm)	Dichroic mirror cut-off (nm)	Emission filter (nm)
M-1220 - Blue	460	455 - 495	500	510LP
M-1220.1 - Blue (pass band)	460	455 - 495	500	518-542
M-1221 - Green	523	510 - 550	570	575LP
M-1221.1 - Green (pass band)	523	510 - 550	570	585-625
M-1222 - Violet	405	390 - 420	440	450LP
M-1223 - UV	365	325 - 375	415	435LP
M-1223.1 - UV (pass band)	365	340 - 390	405	420-470
M-1224 - Red 1	623	590 - 650	660	665LP
M-1225 - Red 2	623	595 - 645	655	665 - 715
M-1226 - Deep Red	660	623 - 678	685	690 - 750
M-1227 - Far Red	740	720 - 760	770	780LP
M-1228 - Amber	590	582 - 603	610	615 - 645

B-510POL - Polarizing Microscope

2

Advanced routine laboratory microscope for transmitted light in brightfield and polarized light observations with strain-free IOS W-PLAN POL objectives. Complete of polarizer and analyzer filters, Bertrand lens for conoscopic observation, compensator plates and high-precision rotatable stages. It comes with the exclusive **X-LED³** illumination system to deliver bright and clear images, along with all the accessories to perform accurate polarization analysis in biology and materials science.

Laboratory

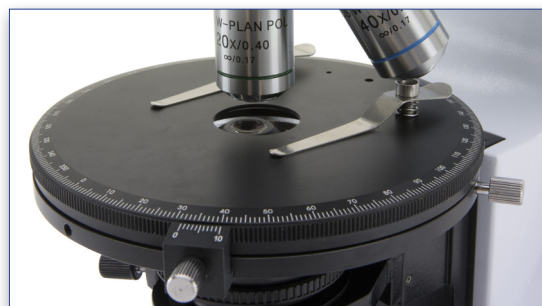
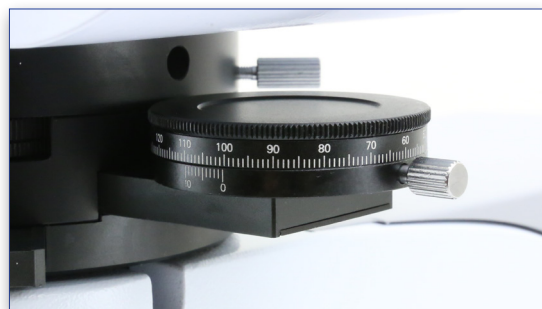
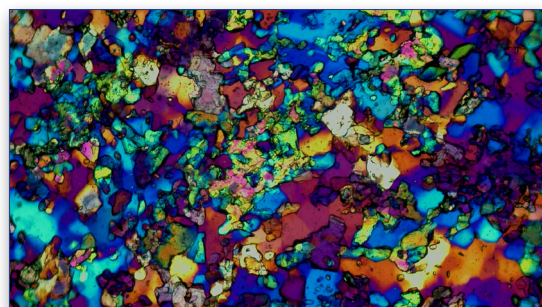

Part	Description
Observation mode:	Brightfield, transmitted polarized light and conoscopy.
Bertrand lens and polarizing attachment:	Swing-out type with centering mechanism for observation in conoscopy/orthoscopy. Rotatable analyzer from 0° to 90° with graduated scale. Tint plates: 1° order red (λ); $\lambda/4$; Quartz wedge.
Head:	Trinocular (fixed 50/50), 30° inclined, 360° rotating.
Interpupillary distance:	Adjustable between 50 and 75 mm.
Dioptric adjustment:	On the left eyepiece tube.
Eyepieces:	WF10x/22 mm, high eye-point and with rubber cups. One with crosshair.
Nosepiece:	Quadruple revolving nosepiece, rotation on ball bearings. Centering system for each objective.

Part	Description
Objectives (strain-free):	IOS W-PLAN POL 4x/0.10 IOS W-PLAN POL 10x/0.25 IOS W-PLAN POL 20x/0.45 IOS W-PLAN POL 40x/0.65 All with anti-fungus treatment.
Specimen stage:	Rotatable stage with locking mechanism and centering knobs. Vernier scale with accuracy 0.1 mm. Diameter 145 mm. Specimen slide clamps.
Focusing:	Coaxial coarse (adjustable tension) and fine focusing mechanism with limit stop to prevent the contact between objective and specimen.
Condenser:	Swing-out N.A. 0.2/0.9, with iris diaphragm, focusable and centerable. With rotating polarizing filter.
Transmitted illumination (Full Koehler type):	X-LED ³ with white 3.6 W LED (6.300 K) with brightness control. Multi-plug 100-240Vac/6Vdc external power supply.

2 B-510POL-I - Polarizing Microscope

Advanced routine laboratory microscope for brightfield and polarized light observations in transmitted and incident light with strain-free IOS LWD W-PLAN POL objectives. Complete of polarizer and analyzer filters, Bertrand lens for conoscopic observation, compensator plates and high-precision rotatable stages. It comes with the exclusive **X-LED³** illumination system to deliver bright and clear images, along with all the accessories to perform accurate polarization analysis in biology and materials science.

- 22
-
-
-
-
-
-
-

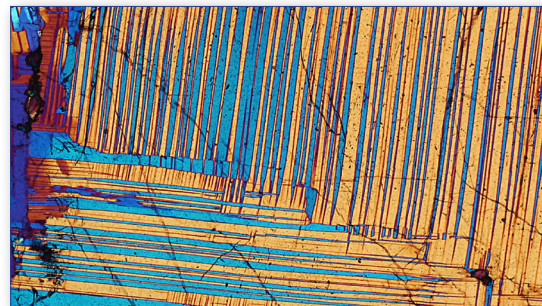

Incident/transmitted light Objectives included

Description
IOS LWD W-PLAN POL 5x/0.12, W.D. 15.5 mm
IOS LWD W-PLAN POL 10x/0.25, W.D. 10.0 mm
IOS LWD W-PLAN POL 20x/0.40, W.D. 5.8 mm
IOS LWD W-PLAN POL 50x/0.75, W.D. 0.32 mm

Part	Description
Observation mode:	Brightfield, transmitted/incident polarized light and conoscopy.
Epi-illumination and filters:	X-LED ³ with white 8 W LED (6.300 K) with brightness control. With polarizer and rotating analyzer for incident illumination, aperture and field diaphragm. With additional filter holder.
Bertrand lens and polarizing attachment:	Swing-out type with centering mechanism for observation in conoscopy/orthoscopy. Rotatable analyzer from 0° to 90° with graduated scale. Tint plates: 1° order red (λ); $\lambda/4$; Quartz wedge.
Head:	Trinocular (fixed 50/50), 30° inclined, 360° rotating.
Interpupillary distance:	Adjustable between 50 and 75 mm.
Dioptric adjustment:	On the left eyepiece tube.
Eyepieces:	WF10x/22 mm, high eye-point and with rubber cups. One with crosshair.
Nosepiece:	Quadruple revolving nosepiece, rotation on ball bearings. Centering system for each objective.

Part	Description
Objectives (strain-free):	IOS LWD W-PLAN POL 5x/0.12 IOS LWD W-PLAN POL 10x/0.25 IOS LWD W-PLAN POL 20x/0.40 IOS LWD W-PLAN POL 50x/0.75 All with anti-fungus treatment.
Specimen stage:	Rotatable stage with locking mechanism and centering knobs. Vernier scale with accuracy 0.1 mm. Diameter 145 mm. Specimen slide clamps.
Focusing:	Coaxial coarse (adjustable tension) and fine focusing mechanism with limit stop to prevent the contact between objective and specimen.
Condenser:	Swing-out N.A. 0.2/0.9, with iris diaphragm, focusable and centerable. With rotating polarizing filter.
Transmitted illumination (Full Koehler type):	X-LED ³ with white 3.6 W LED (6.300 K) with brightness control. Multi-plug 100-240Vac/6Vdc external power supply.

B-510MET - Metallurgical Microscope

2

Advanced routine laboratory microscope with IOS W-PLAN MET objectives and metallurgical attachment with the exclusive **X-LED³** lighting source for incident illumination only. The NCG (no cover glass) objectives are especially designed for microscopy use without a cover slip ideal for metallographic samples and other opaque specimens.

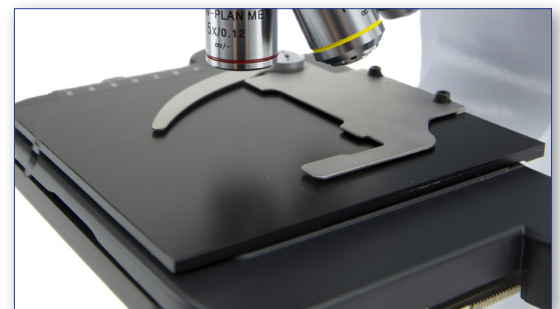
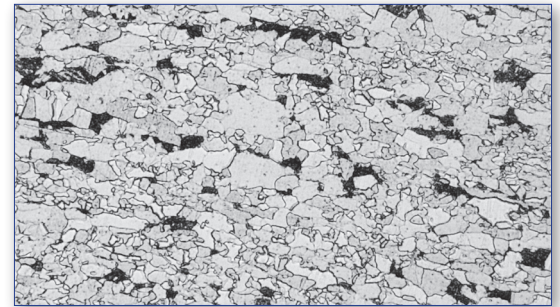

Part	Description
Observation mode:	Brightfield, simple polarized light, oblique illumination on incident light.
Epi-illumination and polarizing filters:	X-LED ³ with white 8 W LED (6.300 K) with brightness control. With aperture and field diaphragms, and oblique illumination system. With polarizer and analyzer. Multi-plug 100-240Vac/6Vdc external power supply.
Head:	Trinocular (fixed 50/50), 30° inclined, 360° rotating.
Interpupillary distance:	Adjustable between 50 and 75 mm.
Dioptric adjustment:	On the left eyepiece tube.
Eyepieces:	WF10x/22 mm, high eye-point and with rubber cups.
Nosepiece:	Quintuple revolving nosepiece, rotation on ball bearings.

Part	Description
Objectives (strain-free):	IOS W-PLAN MET 5x/0.12 IOS W-PLAN MET 10x/0.25 IOS W-PLAN MET 20x/0.40 IOS W-PLAN MET 50x/0.75 All with anti-fungus treatment.
Specimen stage:	Double layer rackless mechanical stage, 233x147 mm, 78x54 mm X-Y range.
Focusing:	Coaxial coarse (adjustable tension) and fine focusing mechanism with limit stop to prevent the contact between objective and specimen.

Laboratory

B-510METR - Metallurgical Microscope

Advanced routine laboratory microscope with IOS W-PLAN MET objectives and metallurgical attachment with the exclusive **X-LED³** lighting source for both transmitted and incident illumination. The NCG (no cover glass) objectives are especially designed for microscopy use without a cover slip ideal for metallographic samples and other opaque specimens.

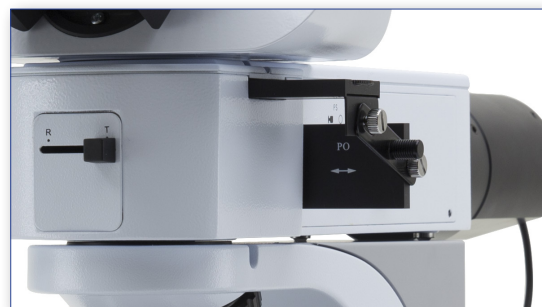
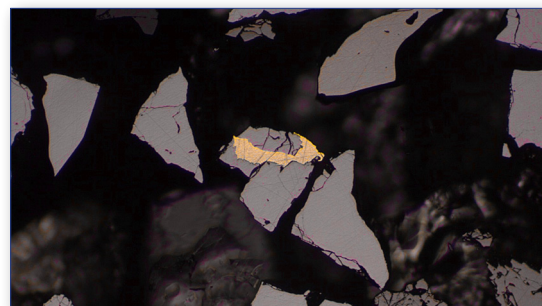

Part	Description
Observation mode:	Brightfield on transmitted light. Brightfield, simple polarized light, oblique illumination on incident light.
Epi-illumination and polarizing filters:	X-LED ⁸ with white 8 W LED (6.300 K) with brightness control. With aperture and field diaphragms, and oblique illumination system. With polarizer and analyzer.
Head:	Trinocular (fixed 50/50), 30° inclined, 360° rotating.
Interpupillary distance:	Adjustable between 50 and 75 mm.
Dioptric adjustment:	On the left eyepiece tube.
Eyepieces:	WF10x/22 mm, high eye-point and with rubber cups.
Nosepiece:	Quintuple revolving nosepiece, rotation on ball bearings.

Part	Description
Objectives (strain-free):	IOS W-PLAN MET 5x/0.12 IOS W-PLAN MET 10x/0.25 IOS W-PLAN MET 20x/0.40 IOS W-PLAN MET 50x/0.75 All with anti-fungus treatment.
Specimen stage:	Double layer rackless mechanical stage, 233x147 mm, 78x54 mm X-Y range. With tempered glass plate.
Focusing:	Coaxial coarse (adjustable tension) and fine focusing mechanism with limit stop to prevent the contact between objective and specimen.
Condenser:	Swing-out N.A. 0.2/0.9, with iris diaphragm, focusable and centerable.
Transmitted illumination (Full Koehler type):	X-LED ³ with white 3.6 W LED (6.300 K) with brightness control. Multi-plug 100-240Vac/6Vdc external power supply.

B-510 - Discussion Microscopes

Advanced routine laboratory microscope for brightfield observations with IOS W-PLAN objectives and rackless stage. Ideal for discussion groups and teaching purpose for multiple observers, up to five users simultaneously. A three-color LED pointer facilitates the indication and identification of the object observed. The high-efficiency **X-LED³** makes it reliable for all transmitted light observations for great-looking, rich and high-quality view.



B-510-2F



B-510-2



B-510-3



B-510-5

Part	Description
Observation mode:	Brightfield
Head:	Trinocular (fixed photo port 50/50), 30° inclined, 360° rotating.
Interpupillary distance:	Adjustable between 50 and 75 mm.
Dioptric adjustment:	On the left eyepiece tube.
Eyepieces:	Main head: WF10x/22 mm, high eye-point and with rubber cups. Additional head(s): WF10x/20 mm, high eye-point.
Nosepiece:	Quintuple revolving nosepiece, rotation on ball bearings.
Objectives:	IOS W-PLAN 4x/0.10 IOS W-PLAN 10x/0.25 IOS W-PLAN 40x/0.65 IOS W-PLAN 100x/1.25 (Oil) All with anti-fungus treatment.

Part	Description
Specimen stage:	Double layer rackless mechanical stage, 233x147 mm, 78x54 mm X-Y range.
Focusing:	Coaxial coarse (adjustable tension) and fine focusing mechanism with limit stop to prevent the contact between objective and specimen.
Condenser:	Swing-out N.A. 0.2/0.9, with iris diaphragm, focusable and centerable.
Transmitted illumination (Full Koehler type):	X-LED ³ with white 3.6 W LED (6,300K) with brightness control. Multi-plug 100-240Vac/6Vdc external power supply.

B-510 Series - Comparison chart

Model	Head	Eyepieces	Nosepiece	Attachment	Objectives
B-510BF	Trinocular (50/50), 30° inclined, 360° rotating	WF10x/22mm, high eye-point	Quintuple, reversed	-	IOS W-PLAN 4x, 10x, 40x, 100x (oil)
B-510ERGO	Binocular ergonomical, 30°- 60° inclined 360° rotating	WF10x/22mm, high eye-point	Quintuple, reversed	-	IOS W-PLAN 4x, 10x, 40x, 100x (oil)
B-510PH	Trinocular (50/50), 30° inclined, 360° rotating	WF10x/22mm, high eye-point	Quintuple, reversed	-	IOS W-PLAN PH 10x, 20x, 40x, 100x (oil)
B-510ASB	Trinocular (50/50), 30° inclined, 360° rotating	WF10x/22mm, high eye-point WF12.5x/15mm w/W&B reticle	Quintuple, reversed	-	IOS W-PLAN 4x, 10x, 40xPH, 100x (oil)
B-510DK	Trinocular (50/50), 30° inclined, 360° rotating	WF10x/22mm, high eye-point	Quintuple, reversed	-	IOS W-PLAN 4x, 10x, 40x, 100x with iris diaphragm (oil)
B-510FL	Trinocular (100/0, 50/50, 0/100), 30° inclined, 360° rotating	WF10x/22mm, high eye-point	Quintuple, reversed	Epi-Florescence attachment, with 4-position filterset slider. Equipped with Blue (FITC) and Green (TRITC) filtersets	IOS W-PLAN F 4x, 10x, 20x, 40x (oil)
B-510LD4	Trinocular (3-position 100/0, 50/50, 0/100), 30° inclined, 360° rotating.	WF10x/22mm, high eye-point	Quintuple, reversed	Epi-Florescence attachment, with 3-position filterset slider. Equipped with Blue filterset (FITC)	B-510LD4: IOS W-PLAN 4x, 10x, 40x, 100x (oil) B-510LD4-SA: IOS W-PLAN F 4x, 10x, 40x, 100x (oil)
B-510POL	Trinocular (50/50), 30° inclined, 360° rotating	WF10x/22mm, high eye-point	Quadruple, reversed. Objective positions centrable.	Swing-out Bertrand lens with centering mechanism for observation in conoscopy/orthoscopy. Rotatable analyzer from 0° to 90° with graduated scale. Tint plates: 1° order red (λ); $\lambda/4$; Quartz wedge	IOS W-PLAN POL 4x, 10x, 20x, 40x
B-510POL-I	Trinocular (50/50), 30° inclined, 360° rotating	WF10x/22mm, high eye-point	Quadruple, reversed. Objective positions centrable.	Incident light attachment with Polarizer for incident illumination, with Aperture & Field diaphragms and additional filter holder. Swing-out Bertrand lens with centering mechanism for observation in conoscopy/orthoscopy. Rotatable analyzer from 0° to 90° with graduated scale. Tint plates: 1° order red (λ); $\lambda/4$; Quartz wedge	IOS LWD W-PLAN POL 5x, 10x, 20x, 50x
B-510MET	Trinocular (50/50), 30° inclined, 360° rotating	WF10x/22mm, high eye-point	Quintuple, reversed	Incident light attachment with Polarizer and rotating Analyzer for incident illumination, with Aperture & Field diaphragms and 2 additional filter holders. Oblique illumination	IOS W-PLAN MET 5x, 10x, 20x, 50x
B-510METR	Trinocular (50/50), 30° inclined, 360° rotating	WF10x/22mm, high eye-point	Quintuple, reversed	Incident light attachment with Polarizer and rotating Analyzer for incident illumination, with Aperture & Field diaphragms and 2 additional filter holders; Epi/Transmitted light selector. Oblique illumination	IOS W-PLAN MET 5x, 10x, 20x, 50x
B-510-2F	Trinocular (50/50), 30° inclined, 360° rotating	WF10x/22mm, high eye-point	Quintuple, reversed	Discussion bridge for 2 observers, Face-to-Face type. 2nd binocular head with WF10x/20mm eyepieces. Equipped with RGB discussion pointer	IOS W-PLAN 4x, 10x, 40x, 100x (oil)
B-510-2	Trinocular (50/50), 30° inclined, 360° rotating	WF10x/22mm, high eye-point	Quintuple, reversed	Discussion bridge for 2 observers, Side-by-Side type. 2nd binocular head with WF10x/20mm eyepieces. Equipped with RGB discussion pointer	IOS W-PLAN 4x, 10x, 40x, 100x (oil)
B-510-3	Trinocular (50/50), 30° inclined, 360° rotating	WF10x/22mm, high eye-point	Quintuple, reversed	Discussion bridge for 3 observers. Additional binocular heads with WF10x/20mm eyepieces. Equipped with RGB discussion pointer	IOS W-PLAN 4x, 10x, 40x, 100x (oil)
B-510-5	Trinocular (50/50), 30° inclined, 360° rotating	WF10x/22mm, high eye-point	Quintuple, reversed	Discussion bridge for 5 observers. Additional binocular heads with WF10x/20mm eyepieces. Equipped with RGB discussion pointer	IOS W-PLAN 4x, 10x, 40x, 100x (oil)

B-510 Series - Comparison chart

Stage	Focusing	Condenser	Incident Illumination	Transmitted Illumination
Double layer, 233x147 mm, moving range 78x54 mm, X-axis rackless	Coaxial coarse and fine, limit stop, adjustable tension	Swing-out type, sliding-in, N.A. 0.2/0.9, with centering system	-	X-LED ³ with white 3.6 W LED (6,300K), brightness control. Full Koehler type.
Double layer, 233x147 mm, moving range 78x54 mm, X-axis rackless	Coaxial coarse and fine, limit stop, adjustable tension	Swing-out type, sliding-in, N.A. 0.2/0.9, with centering system	-	X-LED ³ with white 3.6 W LED (6,300K), brightness control. Full Koehler type.
Double layer, 233x147 mm, moving range 78x54 mm, X-axis rackless	Coaxial coarse and fine, limit stop, adjustable tension	Phase condenser (10x/20x, 40x, 100x) with darkfield (dry) and brightfield	-	X-LED ³ with white 3.6 W LED (6,300K), brightness control. Full Koehler type.
Double layer, 233x147 mm, moving range 78x54 mm, X-axis rackless	Coaxial coarse and fine, limit stop, adjustable tension	Abbe N.A. 1.25, with objective-coded iris diaphragm, focusable and centerable. With 40x phase contrast slider.	-	X-LED ³ with white 3.6 W LED (6,300K), brightness control. Full Koehler type.
Double layer, 233x147 mm, moving range 78x54 mm, X-axis rackless	Coaxial coarse and fine, limit stop, adjustable tension	Swing-out type, sliding-in, N.A. 0.2/0.9, with centering system. Additional darkfield condenser, N.A. 1.36, built-in X-LED ³	-	X-LED ³ with white 3.6 W LED (6,300K), brightness control. Full Koehler type.
Double layer, 233x147 mm, moving range 78x54 mm, X-axis rackless	Coaxial coarse and fine, limit stop, adjustable tension	Swing-out type, sliding-in, N.A. 0.2/0.9, with centering system	High Pressure HBO 100 W mercury bulb	X-LED ³ with white 3.6 W LED (6,300K), brightness control. Full Koehler type.
Double layer, 233x147 mm, moving range 78x54 mm, X-axis rackless	Coaxial coarse and fine, limit stop, adjustable tension	Swing-out type, sliding-in, N.A. 0.2/0.9, with centering system	High-power blue LED with brightness control	X-LED ³ with white 3.6 W LED (6,300K), brightness control. Full Koehler type.
Rotating stage with locking mechanism and centering knobs. Vernier scale with accuracy 0.1 mm. Diameter 145 mm; Specimen slide clamps	Coaxial coarse and fine, limit stop, adjustable tension	Swing-out type, sliding-in, N.A. 0.2/0.9, with centering system. With rotating polarizing filter	-	X-LED ³ with white 3.6 W LED (6,300K), brightness control. Full Koehler type.
Rotating stage with locking mechanism and centering knobs. Vernier scale with accuracy 0.1 mm. Diameter 145 mm; Specimen slide clamps	Coaxial coarse and fine, limit stop, adjustable tension	Swing-out type, sliding-in, N.A. 0.2/0.9, with centering system. With rotating polarizing filter	X-LED ³ with white 8 W LED (6,300K), brightness control	X-LED ³ with white 3.6 W LED (6,300K), brightness control. Full Koehler type.
Double layer, 233x147 mm, moving range 78x54 mm, X-axis rackless; with metal plate for metallurgical samples	Coaxial coarse and fine, limit stop, adjustable tension	-	X-LED ³ with white 8 W LED (6,300K), brightness control	-
Double layer, 233x147 mm, moving range 78x54 mm, X-axis rackless; with glass plate for metallurgical samples	Coaxial coarse and fine, limit stop, adjustable tension	Swing-out type, sliding-in, N.A. 0.2/0.9, with centering system	X-LED ³ with white 8 W LED (6,300K), brightness control	X-LED ³ with white 3.6 W LED (6,300K), brightness control. Full Koehler type.
Double layer, 233x147 mm, moving range 78x54 mm, X-axis rackless	Coaxial coarse and fine, limit stop, adjustable tension	Swing-out type, sliding-in, N.A. 0.2/0.9, with centering system	-	X-LED ³ with white 3.6 W LED (6,300K), brightness control. Full Koehler type.
Double layer, 233x147 mm, moving range 78x54 mm, X-axis rackless	Coaxial coarse and fine, limit stop, adjustable tension	Swing-out type, sliding-in, N.A. 0.2/0.9, with centering system	-	X-LED ³ with white 3.6 W LED (6,300K), brightness control. Full Koehler type.
Double layer, 233x147 mm, moving range 78x54 mm, X-axis rackless	Coaxial coarse and fine, limit stop, adjustable tension	Swing-out type, sliding-in, N.A. 0.2/0.9, with centering system	-	X-LED ³ with white 3.6 W LED (6,300K), brightness control. Full Koehler type.
Double layer, 233x147 mm, moving range 78x54 mm, X-axis rackless	Coaxial coarse and fine, limit stop, adjustable tension	Swing-out type, sliding-in, N.A. 0.2/0.9, with centering system	-	X-LED ³ with white 3.6 W LED (6,300K), brightness control. Full Koehler type.

2 B-510 Series - Accessories

Eyecups & Eyepieces

M-601	WF15x/16 eyepiece, high eyepoint
M-690	Eyecups (pair)
M-780	PL10x/22 eyepiece, high eyepoint, with rubber cup
M-781	PL10x/22 micrometric eyepiece, high eyepoint, with rubber cup
AA-01	12.5x/18 eyepieces (pair), high eyepoint, focusable, W&B reticle

Objectives

IOS W-PLAN

M-1049	IOS W-PLAN objective 2x/0.05
M-1125	IOS W-PLAN objective 4x/0.10
M-1126	IOS W-PLAN objective 10x/0.25
M-1127	IOS W-PLAN objective 20x/0.40
M-1128	IOS W-PLAN objective 40x/0.65
M-634.1	IOS W-PLAN objective 50x/0.95 (oil)
M-1129	IOS W-PLAN objective 60x/0.80
M-1130	IOS W-PLAN objective 100x/1.25 (oil)
M-1130.1	IOS W-PLAN objective 100x/1.25OI - (oil) with iris for DF

IOS W-PLAN F

M-1060	IOS W-PLAN F objective 4x/0.13
M-1061	IOS W-PLAN F objective 10x/0.30
M-1062	IOS W-PLAN F objective 20x/0.50
M-1063	IOS W-PLAN F objective 40x/0.75
M-1064	IOS W-PLAN F objective 100x/1.30 (oil)

IOS W-PLAN MET

M-336	IOS W-PLAN MET objective 5x/0.12
M-338	IOS W-PLAN MET objective 10x/0.25
M-339	IOS W-PLAN MET objective 20x/0.40
M-335	IOS W-PLAN MET objective 50x/0.75
M-698.2	IOS W-PLAN MET objective 100x/0.80 (dry)

IOS W-PLAN PH

M-1120.N	IOS W-PLAN PH objective 10x/0.25
M-1121.N	IOS W-PLAN PH objective 20x/0.40
M-1122.N	IOS W-PLAN PH objective 40x/0.65
M-1123.N	IOS W-PLAN PH objective 100x/1.25 (oil)

IOS W-PLAN POL

M-1131	IOS W-PLAN POL objective 4x/0.10
M-1132	IOS W-PLAN POL objective 10x/0.25
M-1133	IOS W-PLAN POL objective 20x/0.45
M-1134	IOS W-PLAN POL objective 40x/0.65
M-1135	IOS W-PLAN POL objective 60x/0.80
M-1136	IOS LWD W-PLAN POL objective 5x/0.12
M-1137	IOS LWD W-PLAN POL objective 10x/0.25
M-1138	IOS LWD W-PLAN POL objective 20x/0.40
M-1139	IOS LWD W-PLAN POL objective 50x/0.75



M-1037 - Gout analysis kit



M-635 - Heating stage (on newly purchased microscopes, for 233x147mm), multiplug

B-510 Series - Accessories

Stages

- M-175.1 Rotating stage for polarising set (for 233x147mm rackless stage)
- M-635 Heating stage (on newly purchased microscopes, for 233x147mm), multiplug

Condensers & Filters

- M-181 PH set - 10x, 20x, 40x, 100x IOS W-PLAN PH obj. & BF/DF/PH condenser
- M-185 Darkfield condenser for dry objectives (except for B-510DK, B-510MET and B-510METR)
- M-636 Polarising set (filters only) (except for B-510POL & B-510POL-I)
- M-637 Fluorescence filter set V (filterblock not needed) (only for B-510FL)
- M-638 Fluorescence filter set UV-DAPI (filterblock not needed) (only for B-510FL)
- M-975 Blue filter, 45mm diameter
- M-977 Green filter, 45mm diameter
- M-979 Yellow filter, 45mm diameter
- M-989 Frosted glass filter, 45mm diameter
- M-1220 Blue LED Fluorescence Cube (LED+Filterset), (only for B-510LD4)
- M-1220.1 Blue (pass band) LED Fluorescence Cube (LED+Filterset), (only for B-510LD4)
- M-1221 Green LED Fluorescence Cube (LED+Filterset), (only for B-510LD4)
- M-1221.1 Green (pass band) LED Fluorescence Cube (LED+Filterset), (only for B-510LD4)
- M-1222 Violet LED Fluorescence Cube (LED+Filterset), (only for B-510LD4)
- M-1223 UV LED Fluorescence Cube (LED+Filterset), (only for B-510LD4)
- M-1223.1 UV (pass band) LED Fluorescence Cube (LED+Filterset), (only for B-510LD4)
- M-1224 Red 1 LED Fluorescence Cube (LED+Filterset), (only for B-510LD4)
- M-1225 Red 2 LED Fluorescence Cube (LED+Filterset), (only for B-510LD4)
- M-1226 Deep Red LED Fluorescence Cube (LED+Filterset), (only for B-510LD4)
- M-1227 Far Red LED Fluorescence Cube (LED+Filterset), (only for B-510LD4)
- M-1228 Amber LED Fluorescence Cube (LED+Filterset), (only for B-510LD4)

Camera Adapters

- M-113.1 Ring adapter, 30mm (for monocular and binocular microscopes)
- M-115 0.35x C-Mount projection lens
- M-114 0.5x C-Mount projection lens
- M-118 0.75x C-Mount projection lens
- M-173 C-Mount projection lens for APS-C/full frame reflex cameras (trino)
- M-620 0.35x focusable C-Mount adapter (biological microscopes)
- M-620.1 0.5x focusable C-Mount adapter (biological microscopes)
- M-620.2 0.65x focusable C-Mount adapter (biological microscopes)
- M-620.3 1x focusable C-Mount adapter (biological & stereomicroscopes)
- M-699 Universal adapter for C-Mount projection lens (trino)

Miscellaneous

- 15008 Immersion oil, 10ml
- 15009 Immersion oil, 100ml
- 15104 Cleaning kit
- AA-02 HSE-NPL Mark II phase contrast test slide, with certification (only for B-510ASB)
- DC-003 TNT dust cover, medium, 600(l)x550(h) mm
- M-005 Micrometric slide, 26x76mm, with 2 scales (1mm/100 & 10mm/100)
- M-069 Solar charger (except for B-510MET, B-510METR and B-510POL-I)
- M-151 HBO 100W high-pressure mercury bulb for fluorescence (only for B-510FL)
- M-151.1 HBO 100W high-pressure mercury bulb for fluorescence (OSRAM) (only for B-510FL)
- M-1004.N Centering telescope, 30mm diameter (except for B-510MET, B-510METR, B-510POL and B-510POL-I)
- M-1037 Gout analysis kit (only for B-510BF, B-510ERGO and B-510PH)
- VP-510 IQ/OQ/PQ manual for B-510 series
- AB-020 Antibacterial surface treatment, only for newly purchased microscope



How to connect the cameras to our microscopes.

Please refer to the Adapter reference list on Digital section.

15104 - Cleaning kit

It cleans glass quickly and effectively, without leaving residue or odor. Ideal for precision lens or prism cleaning.



M-069 - Solar charger

Included battery: rechargeable – Lithium-Poly. Capacity: 2500 mAh. - Output voltage: 5 Vdc. Autonomy: over 6 hours at medium intensity (X-LED³). Charging models: with solar panel (12h), with external USB power supply (2.5h)



v 6.6.0 - OPTIKA reserves the right to make corrections, modifications, enhancements, improvements and other changes to its products at any time without notice.

Headquarters and Manufacturing Facilities

OPTIKA® S.r.l. Via Rigla, 30 - 24010 Ponteranica (BG) - ITALY - Tel.: +39 035.571.392 - info@optikamicroscopes.com

Optika Sales branches

OPTIKA® Spain spain@optikamicroscopes.com
OPTIKA® China china@optikamicroscopes.com
OPTIKA® India india@optikamicroscopes.com

OPTIKA® USA usa@optikamicroscopes.com
OPTIKA® Central America america@optikamicroscopes.com

OPTIKA[®]
M I C R O S C O P E S
I T A L Y

B-810 & B-1000



Research Lab Upright Microscopes

② B-810/B-1000 - Research Lab Upright Microscopes



B-810/B-1000 - Research Lab Upright Microscopes

OPTIKA Microscopes, thanks to the long experience achieved in microscopy development, has conceived the new B-1000: a major leap in our technological offer. As a flagship instrument, B-1000 originates from customer most demanding feedbacks and needs. Its modularity and versatility will allow to find the perfect place in any clinical or basic research laboratory. All controls are easily accessible and comfortable also for extended periods of observation.

B-1000 is built on IOS Infinity Corrected optical system, which gives both top-notch optical performances, and the possibility to extend your instrument with the broad range of accessories and modules. X-LED illumination is the best solution to have pure white light, very intense even at higher magnification, and optimum power efficiency given by solid state source.

If you are looking for our best solution to your present and future professional demands, B-1000 is the answer.

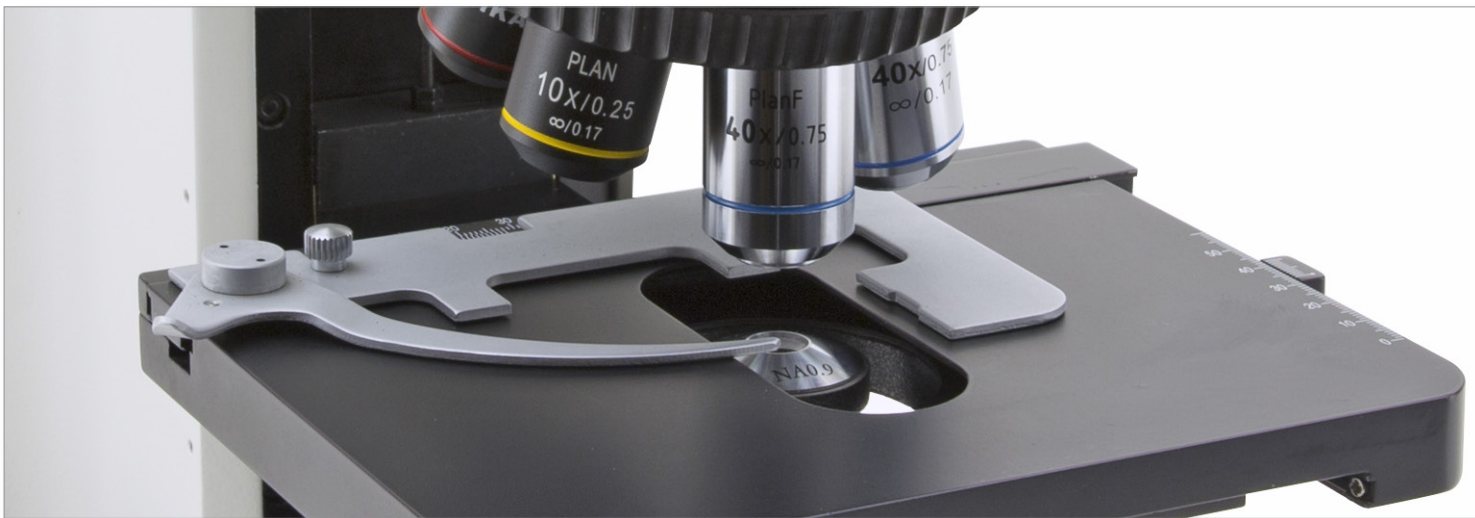

Highest category of optical equipment among our product range guarantees a sharp and clear view in any situation, while top level mechanical design offers sturdiness and long lifetime.



B-810/B-1000 - Research Lab Upright Microscopes

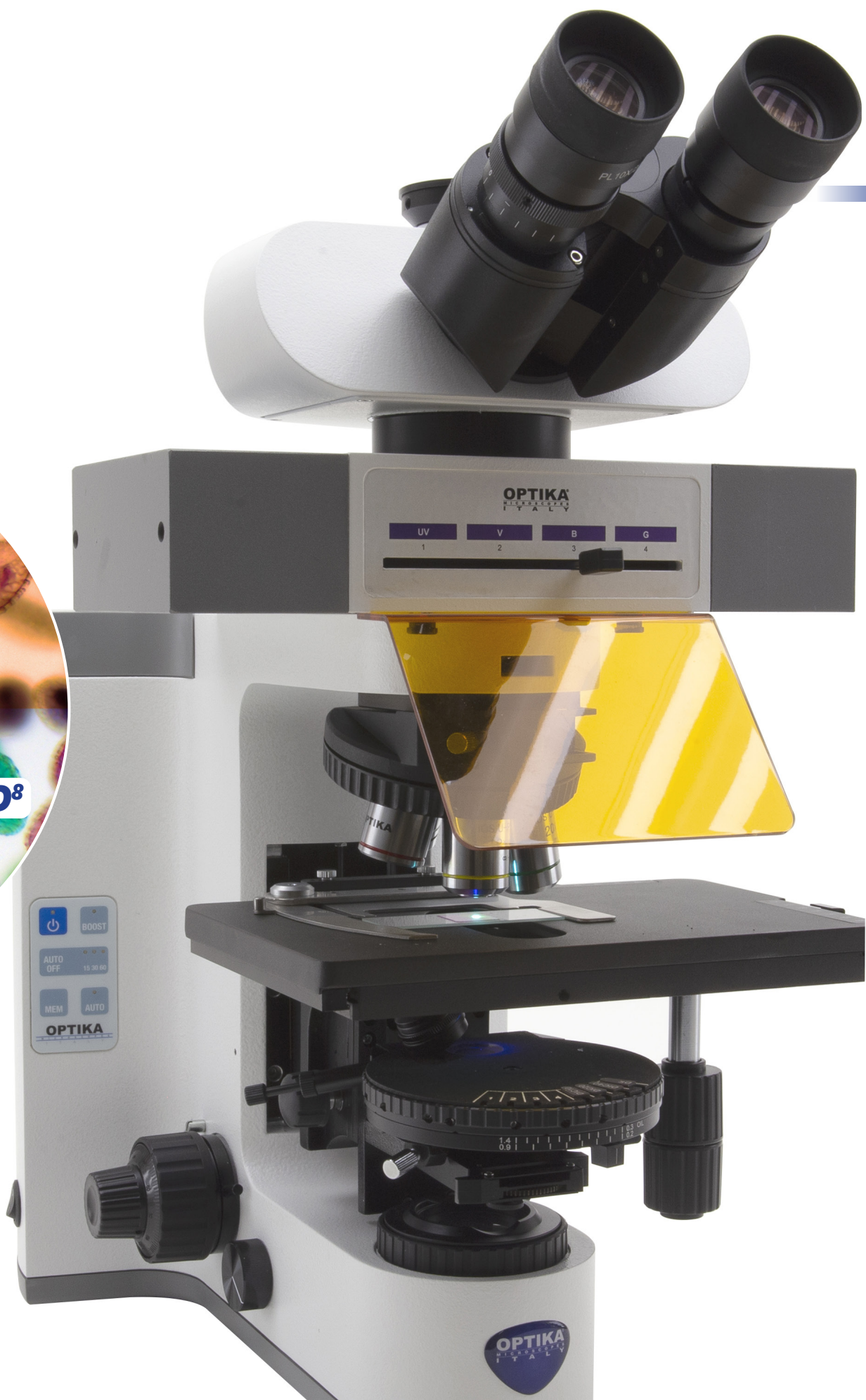
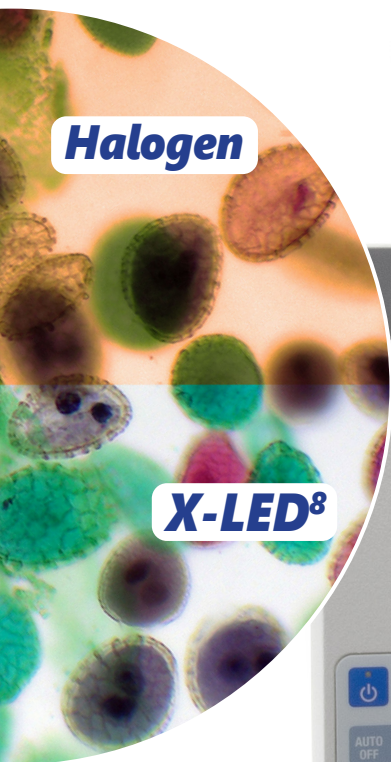

B-810/B-1000 - Research Lab Upright Microscopes

2

Laboratory

Solid Stand – Extra Stability

A completely new design and a die-cast aluminum stand offer solidity and durability, even for the most demanding laboratory use.

This new microscope can seamlessly be upgraded with many attachments that extend its field of use.

X-LED White Illumination

X-LED illumination system is based on a pure white high-efficiency LED and a special optics. It guarantees constant color temperature, no heat, and an extreme electrical consumption efficiency. The whole system is pre-aligned and boasts a lifetime of 50,000 hours.

X-LED benefits

Powerful pure white LED illumination, ideal for brightfield, darkfield and phase contrast applications. Constant color temperature through all the intensity levels. No heat generation, avoiding damage of the specimen. Factory pre-centering assures uniform illumination over the field of view, yet providing perfect Koehler alignment. Very long lifetime and high power efficiency.

Light under control

Intelligent control of the microscope illumination: the "AUTO-OFF" function automatically switches the light off after a user-selectable time period. "BOOST" gives an extra high level of illumination for light-demanding applications. "AUTO" allows to store an illumination level, and to maintain it throughout the inspection.

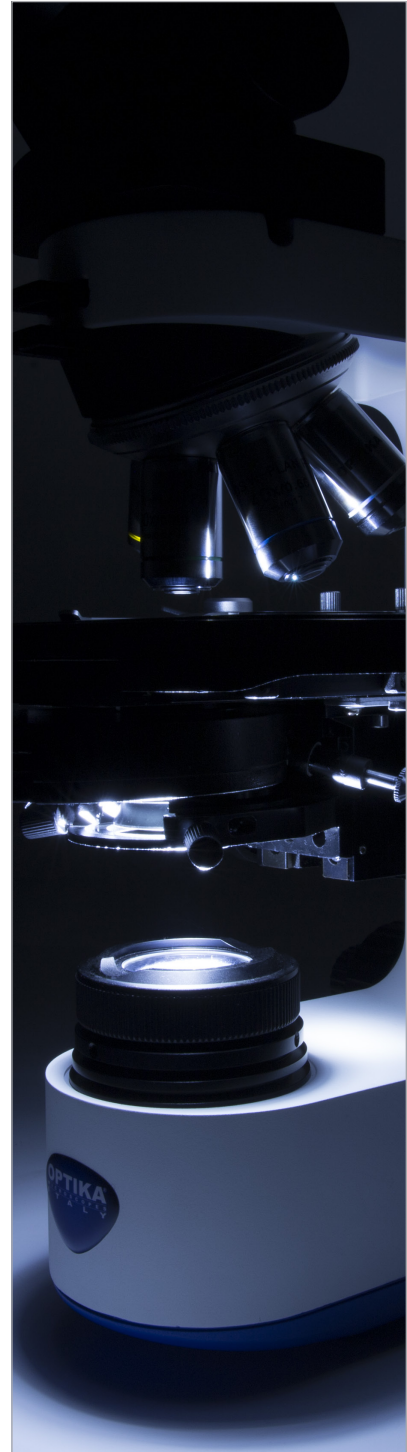

Ergonomy

Low position focus and stage controls allow a fast and comfortable operation. Frequently used controls as light intensity adjustment and diaphragm are also placed in the lower part of the stand and enable operation without having to take the eyes off the specimen. All optical heads are equipped with high-point eyepieces and dioptic adjustment, for the best viewing experience.

B-810/B-1000 - Research Lab Upright Microscopes



Modularity – Build your own solution

Many worlds in one instrument. Modularity allows to build the desired solution (brightfield, darkfield, phase contrast, material science, fluorescence, motorized automation and so on). B-1000 has the flexibility to help your work the best way.

Comfortable Stage

Refined belt-driven stage, with a wide working surface and a highly precise XY movement.

High Quality IOS Optical System

Infinity corrected optical system, based on planachromatic, fluorite and semi-apochromatic objectives, designed to give sharp and clear images, both for the user and the digital camera. Quintuple and sextuple nosepieces give the flexibility to build the objectives that best suits your needs. The system is completed with wide field, high-point eyepieces, with a field number of 24mm.

Ready for Digital Imaging

Range of adapters can accommodate for C-mount digital cameras, as well as reflex cameras. Focus adjustment gives perfectly clear digital images. Our cameras include specific software for capturing, measuring, marking and storing your images. Pro View software allows to perform image acquisition, post-processing, measurements and storage of your images. User can save a preset for later work, or even create a multi-focus composition.



B-810/B-1000 - Research Lab Upright Microscopes

2

Laboratory

Remote-controlled microscope

The stage can be remote-controlled through a dedicated software: X, Y, Z axes, as well as nosepiece, can be moved with a single click. Communication protocol is available for interfacing with custom software, such as automated analysis or autofocus.

X-Y-Z motorized stage
Motorized nosepiece

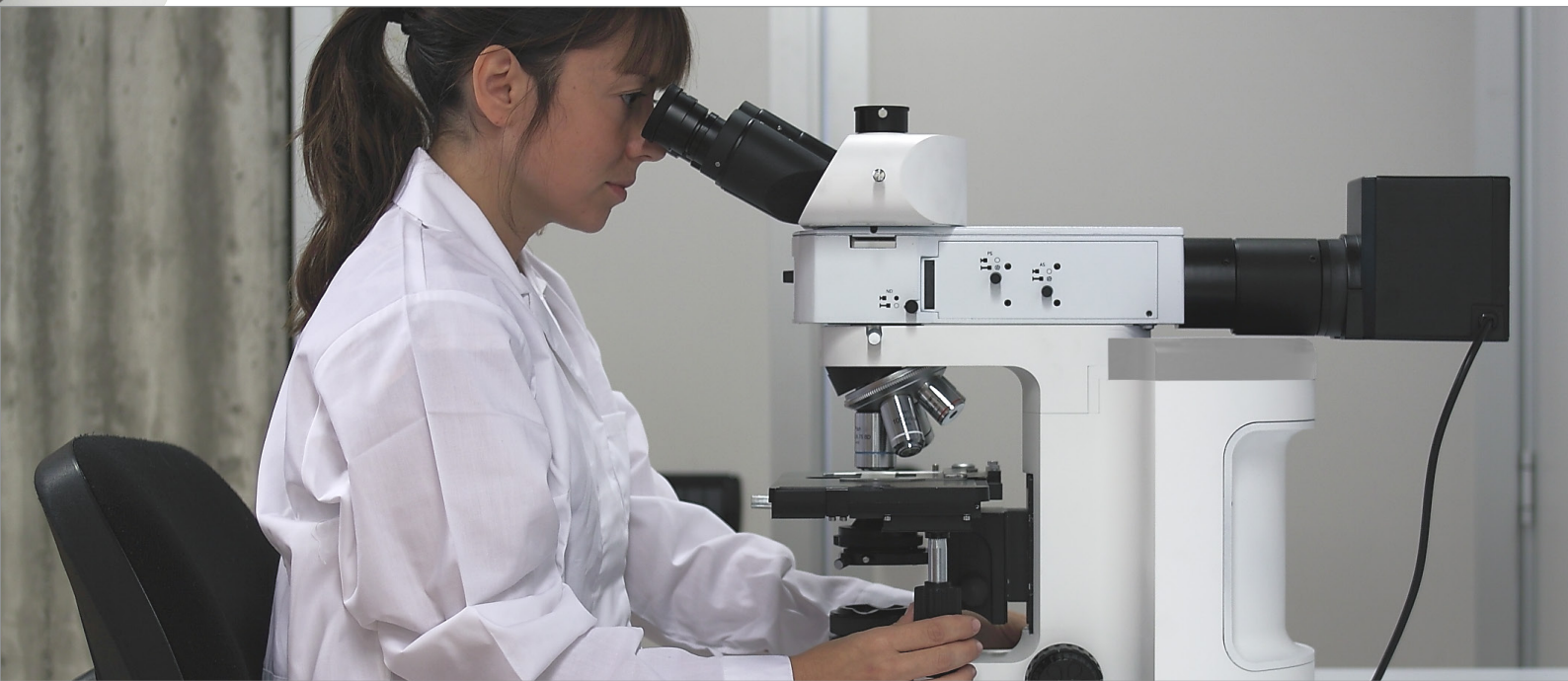

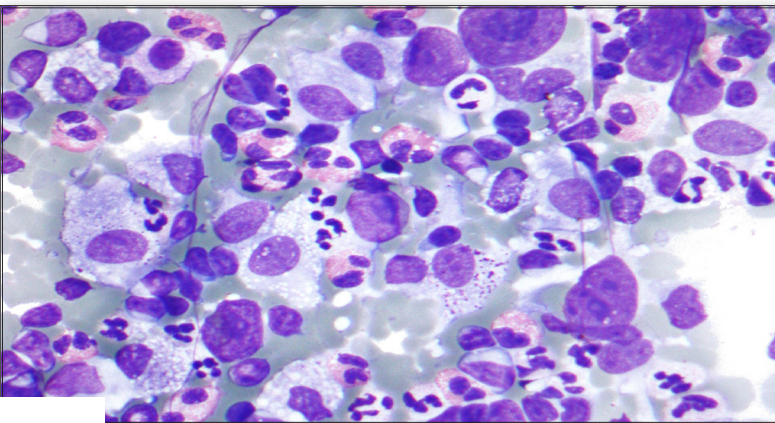

Pathology / Cytology

Since B-810 / B-1000 use white LED illumination, they can maintain the same color temperature even if the brightness is changed. "AUTO" function automatically adjusts the light intensity when the objective is changed or the aperture diaphragm is set to a different value.

These features, along with motorized stage and ergonomic controls, make your workflow easier.

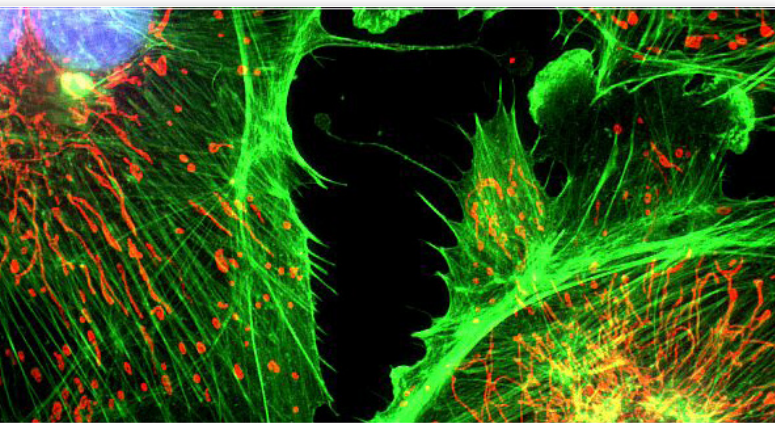

Fluorescence Microscopy

A new attachment for epi-fluorescence provides the ultimate solution in the field of fluorescence diagnostic. Vibration-free six positions filter wheel with shutter, field and aperture diaphragms offer all you need for a complete analysis. Custom filtersets are available and mounted on request. For application where efficiency, rapidity and ease of use are crucial, this model offers also a LED epi-fluorescence attachment, with very high power standard illuminators.

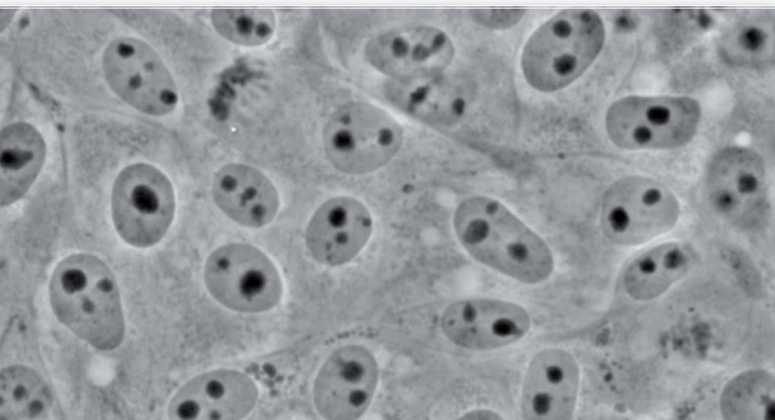

Phase Contrast Microscopy

The bright LED illuminator brings a comfortable view in phase contrast with all magnifications. Universal wheel condenser allows to quickly switch between brightfield, darkfield and phase contrast.

Ideal for clinical laboratories or fibers (e.g. asbestos) analysis.

Darkfield Microscopy

Ideal for observing blood cells, diatoms, small insects, bone, fibers, unstained bacteria, yeast, protozoa, mineral and chemical crystals, colloidal particles, dust-count specimens, and thin sections of polymers and ceramics.

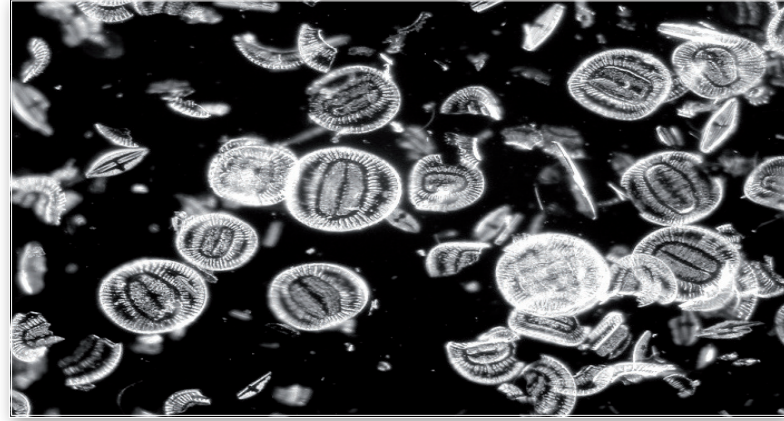

Material Science

A new attachment designed specifically for metallographic inspection, with dedicated objectives set, for the most complete epi-illumination analysis: brightfield, darkfield and polarizing view observations.

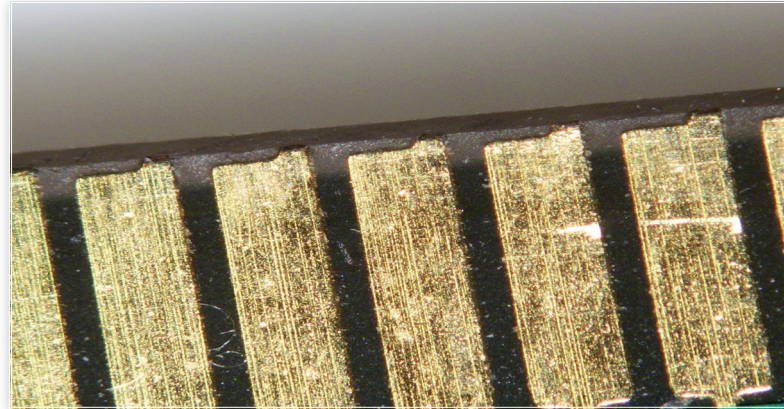

Polarizing Microscopy

Polarized light microscopy is used in geological applications or also for both natural and industrial minerals, composites such as concretes, ceramics, mineral fibers and polymers, and crystalline or biological molecules such as DNA, starch, wood and urea.

Attachments for a full polarization analysis are available (both for transmitted and incident light), so it's possible to look at color fringes right away.

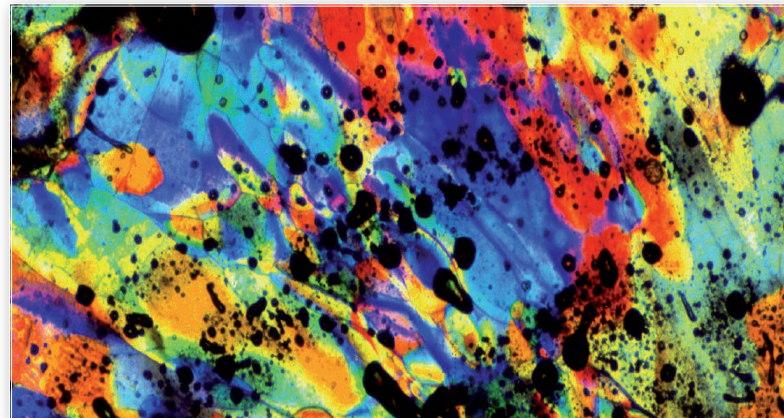

B-810/B-1000 - Design and Production

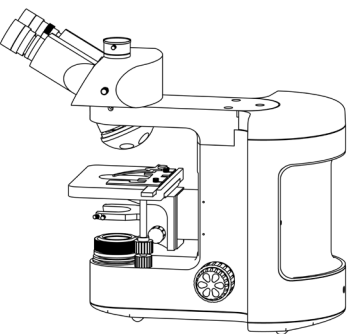
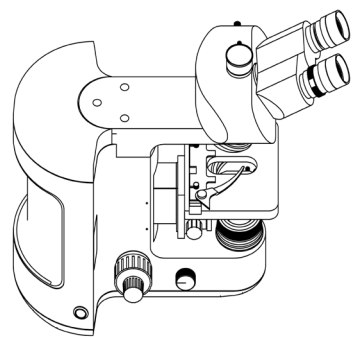
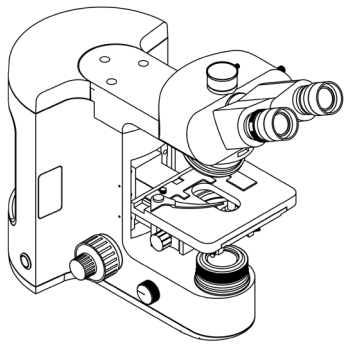
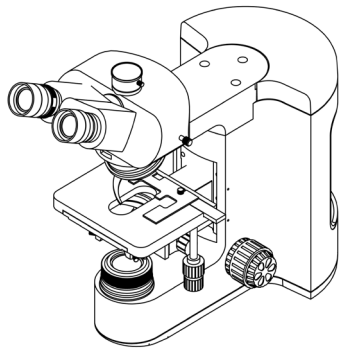

B-810/B-1000 - Design and Production

OPTIKA workshop provides the facilities for precise and reliable optomechanical manufacturing, essential for this kind of instruments.

CNC machining department, equipped with 5-axis milling machine and lathe.



Die-cast stands ready to be processed.



Work in progress inside the milling machine.



Microscope stands exiting from the internal varnishing facility.



All processes are carefully monitored through the application of **ISO 9001 Quality System standards**.

② B-810/B-1000 - Components

Eyepieces



M-1001

PL10x/22 eyepieces (pair), high eyepoint, with rubber cup (retractable)



M-1002

PL10x/24 eyepieces (pair), high eyepoint, with rubber cup (retractable); for B-1000 only



M-1003

PL15x/16 eyepieces (pair), high eyepoint



M-781

PL10x/22 eyepiece, high eyepoint, with micrometric scale (10mm/100um) & rubber cup (retractable)



AA-01

12.5x/15 eyepieces (pair), high eyepoint, with dioptic adjustment, one with W&B graticule for Asbestos



M-1004.N

Centering telescope



Heads



M-1010

Trinocular head, two positions (100/0, 50/50) for B-1000



M-1011

Trinocular head, three positions (100/0, 50/50, 0/100) for B-1000



M-1012

Binocular ERGO head for B-1000



M-1013

Trinocular ERGO head, two positions (100/0, 50/50) for B-1000



M-1188

Trinocular head, single position (50/50) for B-810



2 B-810/B-1000 - Components

Bodies



M-1187

Main body with focus system and X-LED³ illumination for B-810.



M-1021B

Main body with focus system and X-LED⁸ illumination, for general purposes for B-1000.



M-1021M

Main body with focus system and X-LED⁸ illumination, for brightfield metallurgical B-1000.



M-1022M

Main body with focus system (incident light only) for brightfield metallurgical B-1000.



M-1021MD

Main body with focus system and X-LED⁸ illumination, for brightfield/darkfield metallurgical B-1000B-1000.



M-1022MD

Main body with focus system (incident light only), for brightfield/darkfield metallurgical B-1000.



M-1156

Upgrade (controller) for any kind of motorization (stage, Z-axis, nosepiece, or all of them together); for B-1000

M-1149

Motorization of Z-axis for B-1000

Nosepieces



M-1040

Quintuple reversed nosepiece, for RMS objectives; for B-810



M-1041

Sextuple reversed nosepiece, for RMS objectives; for B-810



M-1042

Sextuple reversed nosepiece, for RMS objectives with DIC slot; for B-1000



M-1043

Sextuple motorized reversed nosepiece, for RMS objectives with DIC slot; for B-1000



M-1044

Quintuple reversed nosepiece, with centrable positions for POL objectives; for B-1000



2 B-810/B-1000 - Components

W-PLAN Objectives

Laboratory



Plan Objectives - IOS W-PLAN Series



- M-1049** IOS W-PLAN 2x/0.05
- M-1125** IOS W-PLAN 4x/0.10
- M-1126** IOS W-PLAN 10x/0.25
- M-1127** IOS W-PLAN 20x/0.40
- M-1128** IOS W-PLAN 40x/0.65
- M-1129** IOS W-PLAN 60x/0.80
- M-1130** IOS W-PLAN objective 100x/1.25 (oil)
- M-1130.1** IOS W-PLAN objective 100x/1.25 (Iris)

Plan Objectives - IOS W-PLAN PH Series

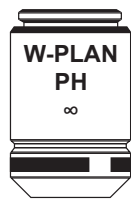

- M-1120.N** IOS W-PLAN PH 10x/0.25
- M-1121.N** IOS W-PLAN PH 20x/0.40
- M-1122.N** IOS W-PLAN PH 40x/0.65
- M-1123.N** IOS W-PLAN PH 100x/1.25 (oil)

Plan Semi-APO Objectives - IOS W-PLAN F Series



- M-1060** IOS W-PLAN F 4x/0.13
- M-1061** IOS W-PLAN F 10x/0.30
- M-1062** IOS W-PLAN F 20x/0.50
- M-1063** IOS W-PLAN F 40x/0.75
- M-1064** IOS W-PLAN F 100x/1.30 (oil)

Plan Objectives - IOS U-PLAN POL Series



- M-1080** IOS U-PLAN POL 4x/0.10
- M-1081** IOS U-PLAN POL 10x/0.25
- M-1081.5** IOS U-PLAN POL 20x/0.45
- M-1082** IOS U-PLAN POL 40x/0.65
- M-1083** IOS U-PLAN POL 60x/0.85

Plan Objectives - IOS LWD W-PLAN MET Series



- M-1099** IOS LWD W-PLAN MET 2.5x/0.08 (with depolarizer)

U-PLAN Objectives



Plan Semi-APO Objectives - **IOS U-PLAN F Series**



- M-1075** IOS U-PLAN F 4x/0.13
- M-1076** IOS U-PLAN F 10x/0.30
- M-1077** IOS U-PLAN F 20x/0.50
- M-1078** IOS U-PLAN F 40x/0.75
- M-1079** IOS U-PLAN F 100x/1.30 (oil)

Plan APO Objectives - **IOS U-PLAN APO Series**



- M-1301** IOS U-PLAN APO 2x/0.08
- M-1302** IOS U-PLAN APO 4x/0.13
- M-1303** IOS U-PLAN APO 10x/0.40
- M-1304** IOS U-PLAN APO 20x/0.75
- M-1305** IOS U-PLAN APO 40x/0.95
- M-1306** IOS U-PLAN APO 60x/0.90
- M-1307** IOS U-PLAN APO 100x/1.35

Plan Semi-APO Objectives - **IOS U-PLAN F PH Series**



- M-1310** IOS U-PLAN F PH 4x/0.13
- M-1311** IOS U-PLAN F PH 10x/0.40
- M-1312** IOS U-PLAN F PH 20x/0.75
- M-1313** IOS U-PLAN F PH 40x/0.95
- M-1314** IOS U-PLAN F PH 60x/0.90
- M-1315** IOS U-PLAN F PH 100x/1.35

M-1157 universal condenser required

Plan Objectives - **IOS LWD U-PLAN POL Series**

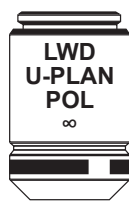

- M-1090** IOS LWD U-PLAN POL 5x/0.15
- M-1091** IOS LWD U-PLAN POL 10x/0.30
- M-1092** IOS LWD U-PLAN POL 20x/0.45
- M-1093** IOS LWD U-PLAN POL 50x/0.55

Plan Objectives - **IOS LWD U-PLAN MET Series**



- M-1100** IOS LWD U-PLAN MET 5x/0.15
- M-1101** IOS LWD U-PLAN MET 10x/0.30
- M-1102** IOS LWD U-PLAN MET 20x/0.45
- M-1103** IOS LWD U-PLAN MET 50x/0.55
- M-1104** IOS LWD U-PLAN MET 100x/0.80 (dry)

Plan Semi-APO Objectives - **IOS LWD U-PLAN F MET Series**



- M-1171** IOS LWD U-PLAN F MET 5x/0.15
- M-1172** IOS LWD U-PLAN F MET 10x/0.30
- M-1173** IOS LWD U-PLAN F MET 20x/0.50
- M-1174** IOS LWD U-PLAN F MET 50x/0.80
- M-1175** IOS LWD U-PLAN F MET 100x/0.90 (dry)

Plan Objectives - **IOS LWD U-PLAN MET BD (Darkfield) Series**

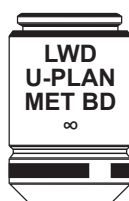

- M-1094** IOS LWD U-PLAN MET BD 5x/0.15
- M-1095** IOS LWD U-PLAN MET BD 10x/0.30
- M-1096** IOS LWD U-PLAN MET BD 20x/0.45
- M-1097** IOS LWD U-PLAN MET BD 50x/0.55
- M-1098** IOS LWD U-PLAN MET BD 100x/0.80 (dry)

Plan Semi-APO Objectives - **IOS LWD U-PLAN F MET BD Series**

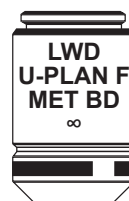

- M-1180** IOS LWD U-PLAN F MET BD 5x/0.15
- M-1181** IOS LWD U-PLAN F MET BD 10x/0.30
- M-1182** IOS LWD U-PLAN F MET BD 20x/0.50
- M-1183** IOS LWD U-PLAN F MET BD 50x/0.80
- M-1184** IOS LWD U-PLAN F MET BD 100x/0.90 (dry)

2 B-810/B-1000 - Components

Stages

Laboratory



M-1140

Standard mechanical stage; 175x145mm for B-1000



M-1141

Rackless mechanical stage; movement knobs with friction adjustment control; 242x157mm; for B-1000.



M-1143

MPC (Mineral Solid Surface) rackless mechanical stage; movement knobs with friction adjustment control; 242x157mm; for B-1000.



M-1148

Metallurgical stage with glass, for metallurgical model; 175x145mm; for B-1000



M-1190

Rackless mechanical stage; 220x149mm; for B-810



Stages



M-1145 + M-1146

Rotating Stage, centrable + attachable XY stage; dia. 172mm; for B-1000

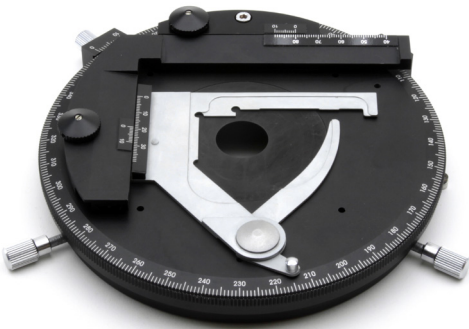

M-1147

Motorized mechanical stage; 242x157mm; for B-1000

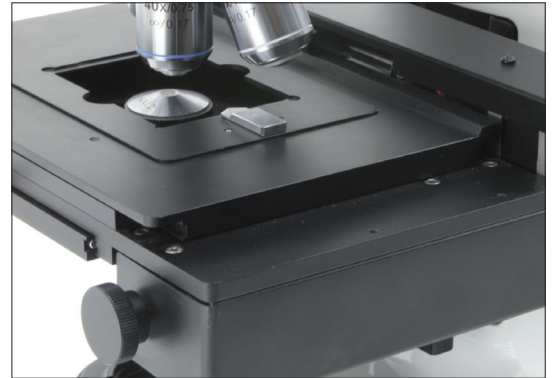

M-1144

Heating stage, with digital temperature controller; 175x145mm; for B-1000.



M-1190H

Heating stage, with digital temperature controller; 220x149mm; for B-810.

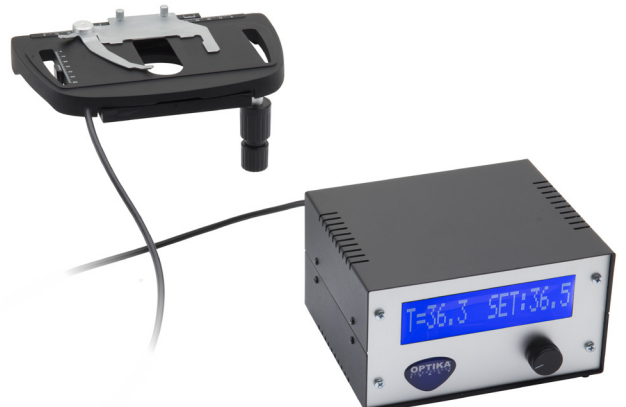

② B-810/B-1000 - Components

Condensers



M-1189

0.90 N.A. swing-out condenser for B-810



M-1150

0.90 N.A. swing-out condenser for B-1000



M-1191

1.2 N.A. swing-out condenser for B-810



M-1151

1.2 N.A. swing-out condenser for B-1000



M-1155

0.9/0.25 N.A. swing-out condenser (to be used with objective M-1049) for B-1000



M-1154

0.70 N.A. swing-out MET condenser for B-1000



Condensers

M-1157 8-Position universal condenser for B-1000



Parts for the universal condenser M-1157

- M-1205** Top lens 0.2 N.A.
- M-1206** Top lens 0.9 N.A.
- M-1207** Top lens 1.4 N.A.
- M-1208** DIC 10x prism
- M-1209** DIC 20x prism
- M-1210** DIC 40x/60x prism
- M-1212** 10x/20x phase ring
- M-1213** 40x/60x phase ring
- M-1214** 100x phase ring
- M-1215** 4x phase ring
- M-1216** Darkfield stop (dry)
- M-1217** Darkfield stop (oil)

M-1153
0.90 N.A. swing-out POL
condenser for B-1000



M-618
Darkfield condenser for dry
objectives for B-1000



M-185
Darkfield condenser for dry
objectives for B-810



M-1124.NO
Phase contrast condenser
with insert slide
10x/20x-40x for B-810



M-1124
Phase contrast condenser
with insert slide
10x/20x-40x for B-1000



M-1152.NO
Phase contrast condenser
10x, 20x, 40x, 100x, BF, DF
for B-810



M-1152.N
Phase contrast condenser
10x, 20x, 40x, 100x, BF, DF
for B-1000



② B-810/B-1000 - Components

Attachments

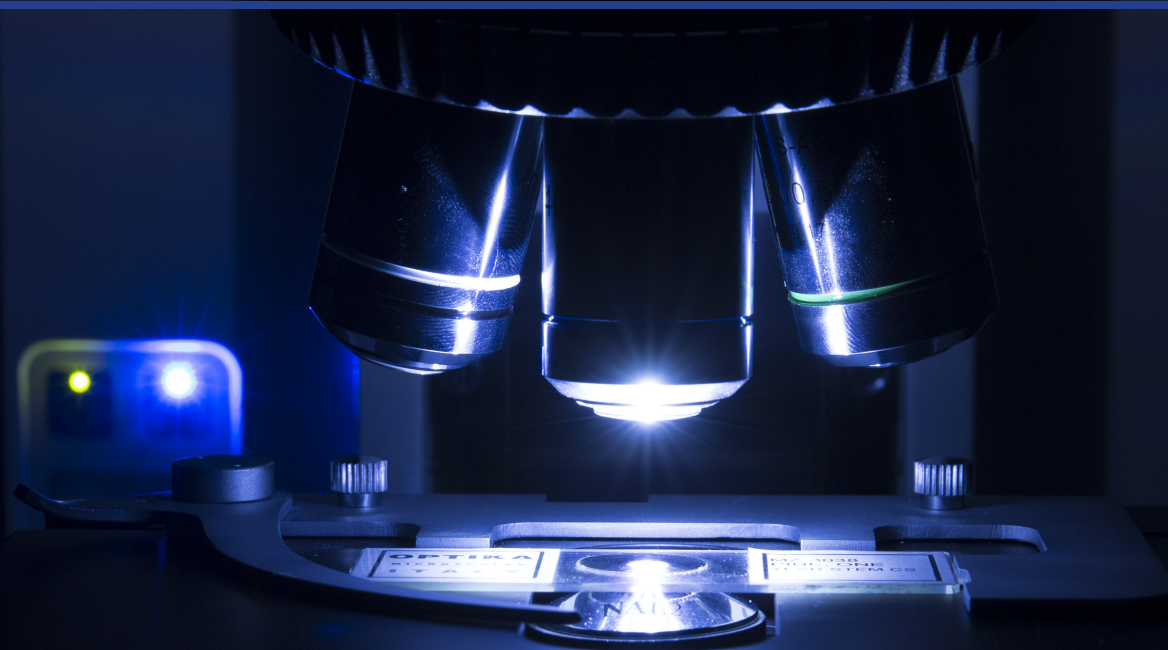

Fluorescence attachments

M-1031M

4-position LED Fluorescence attachment. Without LED-Filtersets (see B-1000 4FLD page for choice); for B-1000



M-1032

6-position HBO Fluorescence attachment, with standard Blue and Green filtersets (FITC & TRITC). With Aperture & Field Diaphragms; for B-1000.



Polarizing attachments

M-1033

Bertrand lens with analyzer and slot for sliders (with Lambda, 1/4 Lambda and Quartz Edge); for B-1000



M-1034

8W X-LED incident polarizing attachment. With Aperture & Field Diaphragms; for B-1000



ALC attachments

M-1030

Automatic Light Control (ALC) system for B-1000

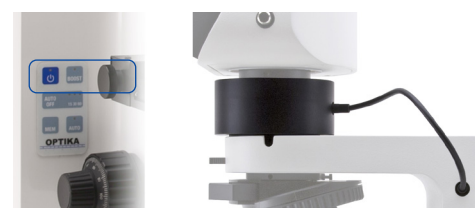

Attachments



Metallurgical attachments

M-1039

Metallurgical attachment for incident brightfield observation, 18 W LED. Equipped with Polarizer and rotating Analyzer. With Aperture & Field Diaphragms. For B-1000.



M-1039MD

Metallurgical attachment for incident brightfield and darkfield observation, 18 W LED. Equipped with Polarizer and rotating Analyzer; with Aperture & Field Diaphragms. Built-in MET nosepiece with 6-positions for 26 mm-Darkfield Metallurgical Objectives. 3 ring adapters for RMS objectives included. For B-1000.



B-810/B-1000 - Components

Discussion Bridges for B-1000



M-1163



M-1159



M-1160



M-1161



M-1162

M-1159

Discussion Bridge with 1 extra head.
Face-to-Face type

M-1160

Discussion Bridge with 1 extra head.
Side-by-Side type

M-1161

Discussion Bridge with 2 extra heads

M-1162

Discussion Bridge with 4 extra heads

M-1163

Discussion Bridge with 9 extra heads

All Discussion Bridges are equipped with extra heads with WF10x/20mm eyepieces

Application Sets

Koehler DIC transmitted

- M-550** - Interferential green filter IF550.
- M-190P** - Polarizer for transmitted light.
- M-1201** - Analyzer for transmitted light.
- M-1202** - DIC prism for transmitted light.



Usable objective series: **IOS W-PLAN F**, **IOS U-PLAN F**. (See page 164)

Transmitted Koehler DIC combined with Fluo HBO

- M-550** - Interferential green filter IF550.
- M-190P** - Polarizer for transmitted light.
- M-1203** - Analyzer for reflected light.
- M-1202** - DIC prism for transmitted light.



Usable objective series: **IOS W-PLAN F**, **IOS U-PLAN F**. (See page 164)

Nomarski DIC transmitted

- M-1157** - 8-Position universal condenser.
- M-1206** - Top lens 0.9 N.A.
- M-1208** - DIC 10x prism for universal condenser.
- M-1209** - DIC 20x prism for universal condenser.
- M-1210** - DIC 40x/60x prism for universal condenser.
- M-1201** - Analyzer for transmitted light.
- M-1202** - DIC prism for transmitted light.



Usable objective series: **IOS U-PLAN F**, **IOS U-PLAN APO**, **IOS U-PLAN F PH**. (See page 162)

Transmitted Nomarski DIC combined with Fluo HBO

- M-1157** - 8-Position universal condenser.
- M-1206** - Top lens 0.9 N.A.
- M-1208** - DIC 10x prism for universal condenser.
- M-1209** - DIC 20x prism for universal condenser.
- M-1210** - DIC 40x/60x prism for universal condenser.
- M-1203** - Analyzer for reflected light.
- M-1202** - DIC prism for transmitted light.



Usable objective series: **IOS U-PLAN F**, **IOS U-PLAN APO**, **IOS U-PLAN F PH**. (See page 162)

Nomarski DIC reflected for metallurgical appl.

- M-870** - DIC prism for metallurgical reflected light.



Usable objective series: **IOS LWD U-PLAN F MET Series**
IOS LWD U-PLAN F MET BD Series.

(See page 162)

GOUT analysis kit

- M-1037** - GOUT analysis kit



B-810 - Brightfield & Phase Contrast Microscope

B-810 is the result of the long experience gathered by OPTIKA Microscopes in the field of light microscopy, offering an extremely valuable product for routine and research laboratory brightfield & phase contrast applications.

Ergonomic design for comfortable long-term use and smooth operation with minimal movements meets the concept of modularity, to offer a the possibility to create a tailored version and match all the personal requirements.

It is qualified as an particularly performing and robust solution, considering the field of view of 22 mm, the state-of-the-art, exclusive **X-LED³** lighting source (3.6 W) and the sturdy dye-cast frame for high stability combined with a wide variety of heads, objectives and condensers to get the most out of a microscope.



B-800
Series

OPTIKA

OPTIKA
MICROSCOPES
BY A.S.

B-810 - Configuration Chart

Build the microscope that suites your needs by choosing among the components



2 B-1000BF - Brightfield Microscope

The modular OPTIKA B-1000 helps you working in a comfortable way during extended periods of use and let you perform reliable, accurate and rapid diagnosis benefiting from modularity, which gives the chance to create customized configurations tailored on customer needs.

Versatile, robust, durable and sturdy, B-1000 offers premium quality optics (including Semi-Apo objectives), the state-of-the-art, exclusive **X-LED[®]** (8 W) illumination system, designed by OPTIKA and the Koehler diaphragm. B-1000 gives multiple options as manual or motorized configuration, with the possibility of **ALC** (Automatic Light Control) and a variety of objectives, stages and condensers.



B-1000BF - Configuration Chart

Build the microscope that suites your needs by choosing among the components



* Code M-1156 must be added only **once** for any motorized configuration

2 B-1000PH - Phase Contrast Microscope

The modular OPTIKA B-1000 is available in phase contrast and helps you working in a comfortable way during extended periods of use performing reliable, accurate and rapid diagnosis benefiting from modularity, which gives the chance to create customized configurations tailored on customer needs. Versatile, robust, durable and sturdy, B-1000 offers premium quality optics, the state-of-the-art, exclusive **X-LED⁸** (8 W) illumination system, designed by OPTIKA and the Koehler diaphragm. B-1000 gives multiple options as manual or motorized configuration, with the possibility of **ALC** (Automatic Light Control) and a variety of objectives, stages and condensers.



B-1000PH - Configuration Chart

Build the microscope that suites your needs by choosing among the components

M-781
PL10x/22 eyepiece,
high eyepoint,
with micrometric scale
(10mm/100um) & rubber cup
(retractable)



M-1001
PL10x/22 eyepieces
(pair), high eyepoint,
with rubber cup
(retractable)



M-1002
PL10x/24 eyepieces
(pair), high eyepoint,
with rubber cup
(retractable)



M-1004.N
Centering telescope



M-1003
PL15x/16 eyepieces
(pair),
high eyepoint



AA-01
12.5x/18 eyepieces (pair),
high eyepoint, with dioptric
adjustment, one with W&B
reticle for Asbestos



M-1011
Trinocular head, three positions
(100/0, 50/50, 0/100)



M-1012
Binocular ERGO head



M-1013
Trinocular ERGO head,
two positions (100/0, 50/50)



M-1030
Automatic Light Control (ALC) system

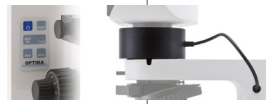

M-1021B
Main body with focus system and X-LED[®] illumination,
for general purposes



M-1021B+M-1156*+M-1149
Main body with motorized system and X-LED[®] illumination,
for general purposes



M-1042
Sextuple reversed nosepiece,
for RMS objectives with DIC slot



M-1043+M-1156*
Sextuple motorized reversed nosepiece,
for RMS objectives with DIC slot



IOS W-PLAN PH



M-1120.N 10x
M-1121.N 20x
M-1122.N 40x
M-1123.N 100x

M-1140
Standard mechanical stage



M-1141
Rackless mechanical stage



M-1143
MPC (Mineral Solid Surface)
rackless mechanical stage



M-1147+M-1156*
Motorized mechanical stage



M-1144
Heating stage, with digital
temperature controller



M-1124
Phase contrast condenser with
insert slide 10x-40x



M-1152.N
Phase contrast condenser 10x, 20x, 40x,
100x, BF, DF



M-977
Green filter, 45mm



* Code M-1156 must be added only **once** for any motorized configuration

2 OPTIKA B-1000FL-HBO - HBO Fluorescence Microscope

The modular OPTIKA B-1000 can stand a HBO fluorescence attachment, helping you working in a comfortable way during extended periods of use and performing reliable, accurate and rapid diagnosis benefiting from modularity, which gives the chance to create customized configurations tailored on customer needs. Versatile, robust, durable and sturdy, B-1000 offers premium quality optics (including Semi-Apo objectives), the state-of-the-art, exclusive **X-LED⁸** (8 W) illumination system, designed by OPTIKA and the Koehler diaphragm.

B-1000 gives multiple options as manual or motorized configuration, with a variety of objectives, stages and condensers.

Standard filterset

Name	Excitation filter (nm)	Dichroic mirror cut-off (nm)	Emission filter (nm)
B Blue	460 - 490	500	520LP
G Green	510 - 550	570	590LP

Additional filterset (optional)

Name	Excitation filter (nm)	Dichroic mirror cut-off (nm)	Emission filter (nm)
V (Violet)	400 - 410	455	455LP
UV	330 - 385	400	420LP



B-1000FL-HBO - Configuration Chart

Build the microscope that suites your needs by choosing among the components

M-781
PL10x/22 eyepiece, high eyepoint,
with micrometric scale (10mm/100um)
& rubber cup (retractable)



M-1001
PL10x/22 eyepieces (pair),
high eyepoint, with rubber cup
(retractable)



M-1003
PL15x/16 eyepieces (pair),
high eyepoint



M-1011
Trinocular head, three positions
(100/0, 50/50, 0/100)



M-1012
Binocular ERGO head



M-1032
6-position HBO Fluorescence attachment, with standard Blue and
Green filtersets (FITC & TRITC)



M-1165
Fluorescence filterset
V (filterblock included)



M-1166
Fluorescence filterset
UV (filterblock included)



M-1021B
Main body with focus system and X-LED[®] illumination,
for general purposes



M-1021B+M-1156*+M-1149
Main body with motorized system and X-LED[®]
illumination, for general purposes



M-1042
Sextuple reversed nosepiece,
for RMS objectives with DIC slot



M-1043+M-1156*
Sextuple motorized reversed nosepiece,
for RMS objectives with DIC slot



IOS W-PLAN F



M-1060 4x
M-1061 10x
M-1062 20x
M-1063 40x
M-1064 100x

IOS U-PLAN F



M-1075 4x
M-1076 10x
M-1077 20x
M-1078 40x
M-1079 100x

M-1140
Standard mechanical stage



M-1141
Rackless mechanical stage



M-1143
MPC (Mineral Solid Surface)
rackless mechanical stage



M-1147+M-1156*
Motorized mechanical stage



M-1144
Heating stage, with digital
temperature controller

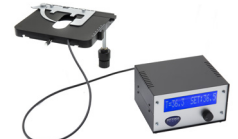

M-1150
0.90 N.A. swing-out
condenser



M-1151
1.2 N.A. swing-out condenser



M-618
Darkfield condenser
for dry objectives



* Code M-1156 must be added only **once** for any motorized configuration

2 B-1000LD4 - LED Fluorescence Microscope

The modular OPTIKA B-1000 can stand a LED fluorescence attachment, helping you working in a comfortable way during extended periods of use and performing reliable, accurate and rapid diagnosis benefiting from modularity, which gives the chance to create customized configurations tailored on customer needs. Versatile, robust, durable and sturdy, B-1000 offers premium quality optics (including Apo and Semi-Apo objectives), the state-of-the-art, exclusive **X-LED³** (8 W) illumination system, designed by OPTIKA and the Koehler diaphragm. B-1000 gives multiple options as manual or motorized configuration, with a variety of objectives, stages and condensers.

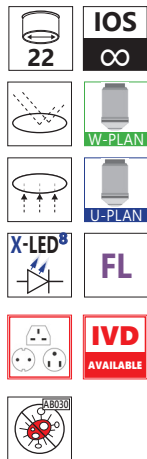

A new milestone achieved in Fluorescence Microscopy

- » Full-modular Fluorescence System
- » Interchangeable LED-Filtersets
- » 4 LED-Filtersets slots
- » 10% higher light intensity than HBO
- » 35% higher light intensity than Metal-Halide
- » Adjustable light intensity
- » The selection of filtersets automatically involves the switching on of the corresponding LEDs
- » Recommended for research applications
- » Cost-effective, money saving technology
- » Ready for immediate operation
- » Eliminate warm-up/cool-down times
- » Forget lamp replacement & centering

LED Fluorescence Cubes available (LED + Filterset)

Name	LED emission (nm)	Excitation filter (nm)	Dichroic mirror cut-off (nm)	Emission filter (nm)
M-1220 - Blue	460	455 - 495	500	510LP
M-1220.1 - Blue (pass band)	460	455 - 495	500	518-542
M-1221 - Green	523	510 - 550	570	575LP
M-1221.1 - Green (pass band)	523	510 - 550	570	585-625
M-1222 - Violet	405	390 - 420	440	450LP
M-1223 - UV	365	325 - 375	415	435LP
M-1223.1 - UV (pass band)	365	340 - 390	405	420-470
M-1224 - Red 1	623	590 - 650	660	665LP
M-1225 - Red 2	623	595 - 645	655	665 - 715
M-1226 - Deep Red	660	623 - 678	685	690 - 750
M-1227 - Far Red	740	720 - 760	770	780LP
M-1228 - Amber	590	582 - 603	610	615 - 645

B-1000LD4 - Configuration Chart

Build the microscope that suites your needs by choosing among the components

M-781
PL10x/22 eyepiece, high eyepoint,
with micrometric scale (10mm/100um)
& rubber cup (retractable)



M-1001
PL10x/22 eyepieces (pair),
high eyepoint, with rubber cup
(retractable)



M-1003
PL15x/16 eyepieces (pair),
high eyepoint



M-1011
Trinocular head, three positions
(100/0, 50/50, 0/100)



M-1012
Binocular ERGO head



M-1031M
4-position LED Fluorescence attachment,
without LED Fluorescence Filtersets

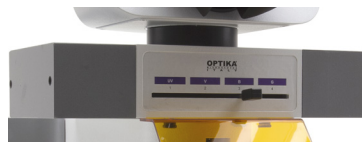

M-1220 ... M-1228
LED Fluorescence Cubes
(LED + Filterset)

M-1021B
Main body with focus system and X-LED[®]
illumination, for general purposes



M-1021B+M-1156*+M-1149
Main body with motorized system and X-LED[®]
illumination, for general purposes



M-1042
Sextuple reversed nosepiece,
for RMS objectives with DIC slot



M-1043+M-1156*
Sextuple motorized reversed nosepiece,
for RMS objectives with DIC slot



IOS W-PLAN



M-1049 2x
M-1125 4x
M-1126 10x
M-1127 20x
M-1128 40x
M-1129 60x
M-1130 100x

IOS W-PLAN F



M-1060 4x
M-1061 10x
M-1062 20x
M-1063 40x
M-1064 100x

IOS U-PLAN F



M-1075 4x
M-1076 10x
M-1077 20x
M-1078 40x
M-1079 100x

M-1140
Standard mechanical stage



M-1141
Rackless mechanical stage



M-1143
MPC (Mineral Solid Surface)
rackless mechanical stage



M-1147+M-1156*
Motorized mechanical stage

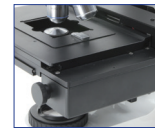

M-1144
Heating stage, with digital
temperature controller

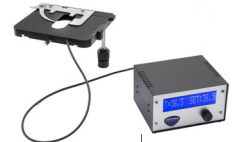

M-1150
0.90 N.A. swing-out
condenser



M-1151
1.2 N.A. swing-out condenser



M-1155
0.9/0.25 N.A. swing-out condenser
(to be used with objective M-1049)



M-618
Darkfield condenser
for dry objectives



* Code M-1156 must be added only **once** for any motorized configuration

2 B-1000POL - Polarizing Microscope

The modular OPTIKA B-1000 is available with transmitted polarized light, helping you working in a comfortable way during extended periods of use and performing reliable, accurate and rapid diagnosis benefiting from modularity, which gives the chance to create customized configurations tailored on customer needs. Versatile, robust, durable and sturdy, B-1000 offers premium quality optics, the state-of-the-art, exclusive **X-LED⁸** (8 W) illumination system, designed by OPTIKA and the Koehler diaphragm.

B-1000 gives multiple options as manual or motorized configuration.



Dedicated version for transmitted
(X-LED⁸, 8 W)
illumination and polarization analysis.

B-1000POL - Configuration Chart

Build the microscope that suites your needs by choosing among the components

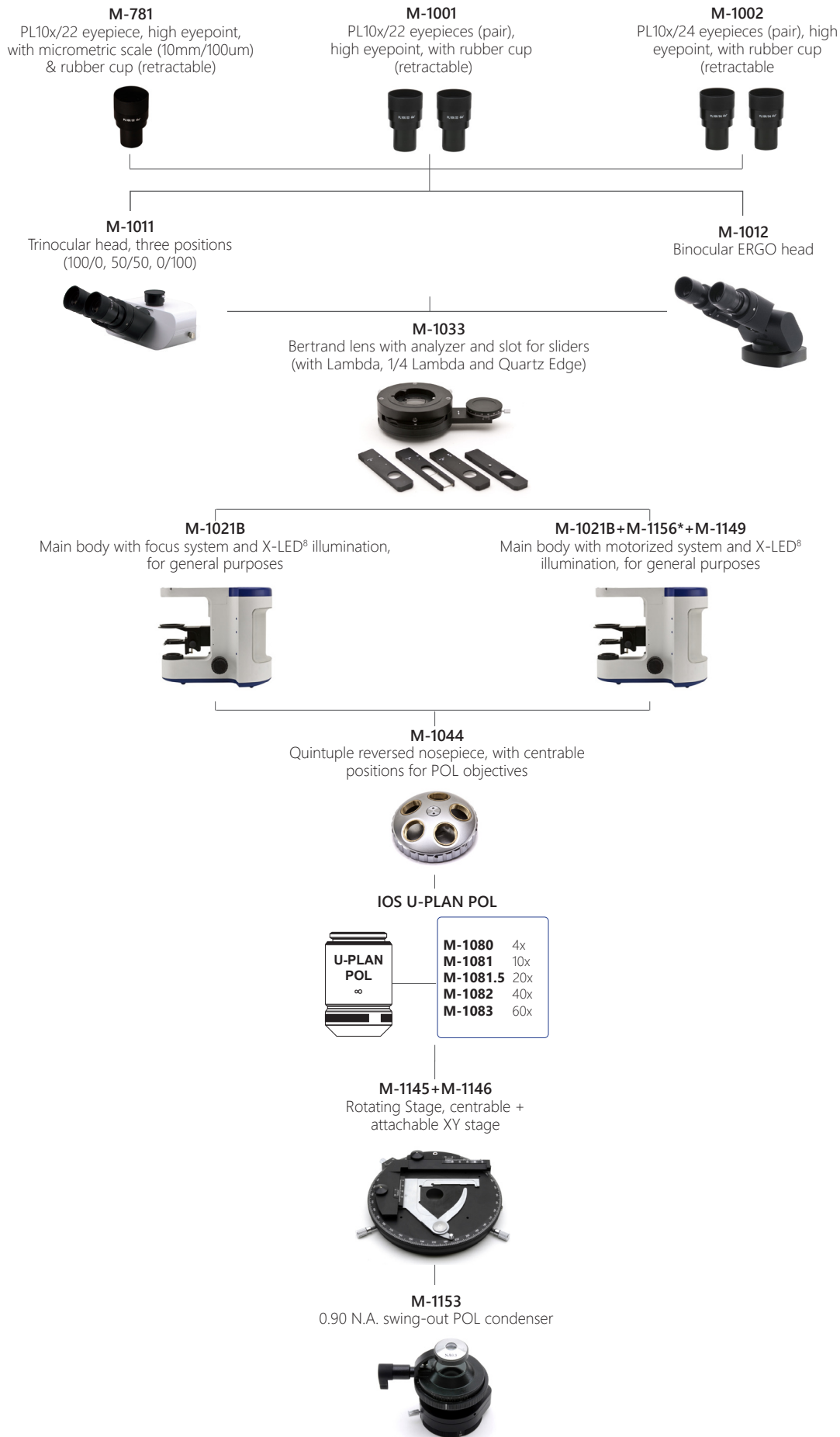

* Code M-1156 must be added only **once** for any motorized configuration

2 OPTIKA B-1000POL-I - Polarizing Microscope

The modular OPTIKA B-1000 is available with transmitted and incident polarized light, helping you working in a comfortable way during extended periods of use and performing reliable, accurate and rapid diagnosis benefiting from modularity, which gives the chance to create customized configurations tailored on customer needs. Versatile, robust, durable and sturdy, B-1000 offers premium quality optics, the state-of-the-art, exclusive **X-LED[®]** (8 W) illumination system, designed by OPTIKA and the Koehler diaphragm. B-1000 gives multiple options as manual or motorized configuration.

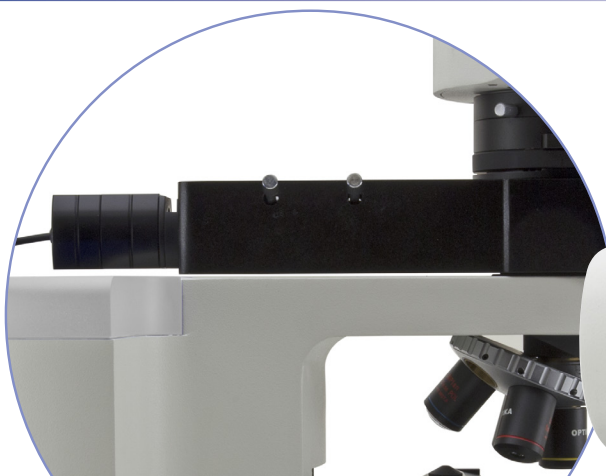

Dedicated version for transmitted and incident illumination (**X-LED[®]**, 8 W)



B-1000POL-I - Configuration Chart

Build the microscope that suites your needs by choosing among the components

M-781
PL10x/22 eyepiece, high eyepoint,
with micrometric scale (10mm/100um)
& rubber cup (retractable)



M-1001
PL10x/22 eyepieces (pair),
high eyepoint, with rubber cup
(retractable)



M-1011
Trinocular head, three positions
(100/0, 50/50, 0/100)



M-1012
Binocular ERGO head



M-1033
Bertrand lens with analyzer and slot for sliders
(with Lambda, 1/4 Lambda and Quartz Edge)



M-1034
Incident polarizing attachment



M-1021B
Main body with focus system and X-LED[®] illumination,
for general purposes



M-1021B+M-1156*+M-1149
Main body with motorized system and X-LED[®]
illumination, for general purposes



M-1044
Quintuple reversed nosepiece, with centrable
positions for POL objectives



IOS LWD U-PLAN POL



M-1090 5x
M-1091 10x
M-1092 20x
M-1093 50x

M-1145+M-1146
Rotating Stage, centrable +
attachable XY stage



M-1153
0.90 N.A. swing-out POL condenser



* Code M-1156 must be added only **once** for any motorized configuration

② B-1000METBF - Brightfield Metallurgical Microscope

The modular OPTIKA B-1000METBF offers superior quality **brightfield incident light**, helping you working in a comfortable way during extended periods of use and performing reliable, accurate and rapid diagnosis benefiting from modularity, which gives the chance to create customized configurations tailored on customer needs. Versatile, robust, durable and sturdy, B-1000 offers premium quality optics, the state-of-the-art, exclusive **X-LED³** (8 W) transmitted illumination (Koehler system). The incident light relies on an incredibly bright 18 W LED illumination, designed by OPTIKA. B-1000 gives multiple options as manual or motorized configuration.



B-1000METBF - Configuration Chart

Build the microscope that suites your needs by choosing among the components

M-781
PL10x/22 eyepiece, high eyepoint,
with micrometric scale (10mm/100um)
& rubber cup (retractable)



M-1001
PL10x/22 eyepieces (pair),
high eyepoint, with rubber cup
(retractable)



M-1003
PL15x/16 eyepieces (pair),
high eyepoint



M-1011
Trinocular head, three positions
(100/0, 50/50, 0/100)



M-1012
Binocular ERGO head



M-1039
Metallurgical attachment, 18 W LED



M-1021M
Main body with focus system
and X-LED[®] illumination,
for metallurgical model

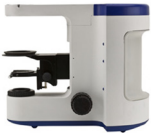

M-1021M+M-1156*+M-1149
Main body with motorized focus system
and X-LED[®] illumination,
for metallurgical model



M-1022M
Main body with focus system,
for metallurgical model with
incident light only



M-1022M+M-1156*+M-1149
Main body with motorized focus
system, for metallurgical model with
incident light only



M-1042
Sextuple reversed nosepiece,
for RMS objectives with DIC slot



M-1043+M-1156*
Sextuple motorized reversed nosepiece,
for RMS objectives with DIC slot



IOS LWD W-PLAN MET



M-1099 2.5x

IOS LWD U-PLAN MET



M-1100 5x
M-1101 10x
M-1102 20x
M-1103 50x
M-1104 100x

IOS LWD U-PLAN F MET



M-1171 5x
M-1172 10x
M-1173 20x
M-1174 50x
M-1175 100x

M-1148
Mechanical stage with glass,
for metallurgical model



M-1147+M-1156*
Motorized mechanical stage



M-1154
0.70 N.A. swing-out MET condenser



* Code M-1156 must be added only **once** for any motorized configuration

2 OPTIKA B-1000METDK - Darkfield Metallurgical Microscope

The modular OPTIKA B-1000METDK offers superior quality **brightfield and darkfield incident light**, helping you working in a comfortable way during extended periods of use and performing reliable, accurate and rapid diagnosis benefiting from modularity, which gives the chance to create customized configurations tailored on customer needs. Versatile, robust, durable and sturdy, B-1000 offers premium quality optics, the state-of-the-art, exclusive **X-LED³** (8 W) transmitted illumination (Koehler system). The incident light relies on an incredibly bright 18 W LED illumination, designed by OPTIKA. B-1000 gives multiple options as manual or motorized configuration.



B-1000METDK - Configuration Chart

Build the microscope that suites your needs by choosing among the components

M-781
PL10x/22 eyepiece, high eyepoint, with micrometric scale (10mm/100um) & rubber cup (retractable)



M-1001
PL10x/22 eyepieces (pair), high eyepoint, with rubber cup (retractable)



M-1003
PL15x/16 eyepieces (pair), high eyepoint



M-1011
Trinocular head, three positions (100/0, 50/50, 0/100)



M-1012
Binocular ERGO head



M-1039MD
Metallurgical attachment 18 W LED (Built-in MET nosepiece with 6-positions)



M-1021MD
Main body with focus system and X-LED8 illumination, for brightfield/darkfield metallurgical B-1000



M-1021MD+M-1156*+M-1149
Main body with motorized focus system and X-LED8 illumination, for brightfield/darkfield metallurgical B-1000



M-1022MD
Main body with focus system (incident light only), for brightfield/darkfield metallurgical B-1000



M-1022MD+M-1156*+M-1149
Main body with motorized focus system (incident light only), for brightfield/darkfield metallurgical B-1000

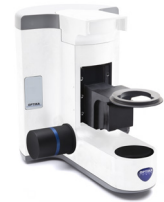

IOS LWD W-PLAN MET



M-1099 2.5x

IOS LWD U-PLAN MET



M-1100 5x
M-1101 10x
M-1102 20x
M-1103 50x
M-1104 100x

IOS LWD U-PLAN F MET



M-1171 5x
M-1172 10x
M-1173 20x
M-1174 50x
M-1175 100x

IOS LWD U-PLAN MET BD



M-1094 5x
M-1095 10x
M-1096 20x
M-1097 50x
M-1098 100x

IOS LWD U-PLAN F MET BD



M-1180 5x
M-1181 10x
M-1182 20x
M-1183 50x
M-1184 100x

M-1148
Mechanical stage with glass, for metallurgical model



M-1147+M-1156*
Motorized mechanical stage



M-1154
0.70 N.A. swing-out MET condenser



* Code M-1156 must be added only **once** for any motorized configuration

B-1000 Multi-Head - Discussion Microscopes

The modular OPTIKA B-1000 helps you working in a comfortable way during extended periods of use and let you perform reliable, accurate and rapid diagnosis benefiting from modularity, which gives the chance to create customized configurations tailored on customer needs.

Versatile, robust, durable and sturdy, B-1000 offers premium quality optics (including Semi-Apo objectives), the state-of-the-art, exclusive **X-LED** illumination system, designed by OPTIKA and the Koehler diaphragm. B-1000 gives multiple options as manual or motorized configuration, with a variety of objectives, stages and condensers. Ideal for discussion groups and teaching purpose for multiple observers, up to ten users simultaneously.

A three-color LED pointer facilitates the indication and identification of the object observed (except the model B-1000Ti-10).



B-1000Ti-2 - multi-head microscope for 2 users

B-1000Ti-3 - multi-head microscope for 3 users

B-1000Ti-5 - multi-head microscope for 5 users

B-1000Ti-10 - multi-head microscope for 10 users



B-1000 Multi-Head - Configuration Chart

Build the microscope that suites your needs by choosing among the components

M-781
PL10x/22 eyepiece, high eyepoint, with micrometric scale (10mm/100um) & rubber cup (retractable)



M-1001
PL10x/22 eyepieces (pair), high eyepoint, with rubber cup (retractable)



M-1003
PL15x/16 eyepieces (pair), high eyepoint



M-1011
Trinocular head, three positions (100/0, 50/50, 0/100)



M-1012
Binocular ERGO head



- M-1159** - Multi-head attachment, 1 extra head (face-to-face)
- M-1160** - Multi-head attachment, 1 extra head
- M-1161** - Multi-head attachment, 2 extra head
- M-1162** - Multi-head attachment, 4 extra head
- M-1163** - Multi-head attachment, 9 extra head

M-1021B
Main body with focus system and X-LED[®] illumination, for general purposes



M-1021B+M-1156*+M-1149
Main body with motorized system and X-LED[®] illumination, for general purposes



M-1042
Sextuple reversed nosepiece, for RMS objectives with DIC slot



M-1043+M-1156*
Sextuple motorized reversed nosepiece, for RMS objectives with DIC slot



IOS W-PLAN PH



- M-1120.N** 10x
- M-1121.N** 20x
- M-1122.N** 40x
- M-1123.N** 100x

IOS W-PLAN



- M-1049** 2x
- M-1125** 4x
- M-1126** 10x
- M-1127** 20x
- M-1128** 40x
- M-1129** 60x
- M-1130** 100x

IOS W-PLAN F



- M-1060** 4x
- M-1061** 10x
- M-1062** 20x
- M-1063** 40x
- M-1064** 100x

IOS U-PLAN F



- M-1075** 4x
- M-1076** 10x
- M-1077** 20x
- M-1078** 40x
- M-1079** 100x

M-1140
Standard mechanical stage



M-1141
Rackless mechanical stage



M-1143
MPC (Mineral Solid Surface) rackless mechanical stage



M-1147+M-1156*
Motorized mechanical stage



M-1144
Heating stage, with digital temperature controller



M-1150
0.90 N.A. swing-out condenser



M-1152.N
Phase contrast condenser 10x, 20x, 40x, 100x, BF, DF



M-1124
Phase contrast condenser with insert slide 10x-40x



M-1151
1.2 N.A. swing-out condenser



M-1155
0.9/0.25 N.A. swing-out condenser (to be used with objective M-1049)



M-618
Darkfield condenser for dry objectives



M-977
Green filter, 45mm



* Code M-1156 must be added only **once** for any motorized configuration

B-810/B-1000 - Accessories

Eyecups & Eyepieces

M-690 Eyecups (pair)

Condensers & Filters

- M-613 Polarizing set (filters only) (except for B-1000FL-LED, B-1000MET, B-1000POL, and B-1000POL-I)
 M-615 Lambda filter for polarizing set (except for B-1000FL-LED, B-1000MET, B-1000POL, and B-1000POL-I)
 M-617.1NO Phase contrast set with IOS W-PLAN objective 40x (only for B-810)
 M-617.1N Phase contrast set with IOS W-PLAN objective 40x (only for B-1000)
 M-975 Blue filter, 45mm diameter (except for B-1000MET)
 M-977 Green filter, 45mm diameter (except for B-1000MET)
 M-979 Yellow filter, 45mm diameter (except for B-1000MET)
 M-989 Frosted glass filter, 45mm diameter (except for B-1000MET)
 M-1164 Empty fluorescence filterblock (only for B-1000FL-HBO)
 M-1165 Fluorescence filter set V (filterblock included) (only for B-1000FL-HBO)
 M-1166 Fluorescence filter set UV-DAPI (filterblock included) (only for B-1000FL-HBO)
 M-1220 Blue LED Fluorescence Cube (LED+Filterset), (only for B-1000LD4)
 M-1220.1 Blue (pass band) LED Fluorescence Cube (LED+Filterset), (only for B-1000LD4)
 M-1221 Green LED Fluorescence Cube (LED+Filterset), (only for B-1000LD4)
 M-1221.1 Green (pass band) LED Fluorescence Cube (LED+Filterset), (only for B-1000LD4)
 M-1222 Violet LED Fluorescence Cube (LED+Filterset), (only for B-1000LD4)
 M-1223 UV LED Fluorescence Cube (LED+Filterset), (only for B-1000LD4)
 M-1223.1 UV (pass band) LED Fluorescence Cube (LED+Filterset), (only for B-1000LD4)
 M-1224 Red 1 LED Fluorescence Cube (LED+Filterset), (only for B-1000LD4)
 M-1225 Red 2 LED Fluorescence Cube (LED+Filterset), (only for B-1000LD4)
 M-1226 Deep Red LED Fluorescence Cube (LED+Filterset), (only for B-1000LD4)
 M-1227 Far Red LED Fluorescence Cube (LED+Filterset), (only for B-1000LD4)
 M-1228 Amber LED Fluorescence Cube (LED+Filterset), (only for B-1000LD4)
 M-ND25 Neutral density filter, 25% transmission (only for B-1000FL-HBO)

Camera Adapters

- M-113.1 Ring adapter, 30mm (for monocular and binocular microscopes)
 M-115 0.35x C-Mount projection lens
 M-114 0.5x C-Mount projection lens
 M-118 0.75x C-Mount projection lens
 M-173 C-Mount projection lens for APS-C/full frame reflex cameras (trino)
 M-620 0.35x focusable C-Mount adapter (biological microscopes)
 M-620.1 0.5x focusable C-Mount adapter (biological microscopes)
 M-620.2 0.65x focusable C-Mount adapter (biological microscopes)
 M-620.3 1x focusable C-Mount adapter (biological & stereomicroscopes)
 M-699 Universal adapter for C-Mount projection lens (trino)

Miscellaneous

- 15008 Immersion oil, 10ml
 15009 Immersion oil, 100ml
 15104 Cleaning kit
 AA-02 HSE-NPL Mark II phase contrast test slide, with certification (only for B-810 & B-1000PH)
 DC-005 TNT dust cover, extra large, 820(l)x550(h) mm
 M-005 Micrometric slide, 26x76mm, with 2 scales (1mm/100 & 10mm/100)
 M-151 HBO 100W high-pressure mercury bulb for fluorescence
 M-151.1 HBO 100W high-pressure mercury bulb for fluorescence (OSRAM)
 VP-1000 IQ/OQ/PQ manual for B-1000 series (Brightfield)
 VP-1000MET IQ/OQ/PQ manual for B-1000 series (Metallographic)
 VP-1000POL IQ/OQ/PQ manual for B-1000 series (Polarizing)
 VP-810 IQ/OQ/PQ manual for B-810 series
 VP-1000PH IQ/OQ/PQ manual for B-1000 series (Phase Contrast)
 VP-1000FL IQ/OQ/PQ manual for B-1000 series (Fluorescence)
 AB-030 Antibacterial surface treatment, only for newly purchased microscope

15104 - Cleaning kit

It cleans glass quickly and effectively, without leaving residue or odor. Ideal for precision lens or prism cleaning.



How to connect the cameras to our microscopes.

Please refer to the Adapter reference list on Digital section.

v 6.6.0 - OPTIKA reserves the right to make corrections, modifications, enhancements, improvements and other changes to its products at any time without notice.

Headquarters and Manufacturing Facilities

OPTIKA® S.r.l. Via Rigla, 30 - 24010 Ponteranica (BG) - ITALY - Tel.: +39 035.571.392 - info@optikamicroscopes.com

Optika Sales branches

OPTIKA® Spain spain@optikamicroscopes.com
OPTIKA® China china@optikamicroscopes.com
OPTIKA® India india@optikamicroscopes.com

OPTIKA® USA usa@optikamicroscopes.com
OPTIKA® Central America camerica@optikamicroscopes.com

OPTIKA®
MICROSCOPES
I T A L Y

IM-3 Series



Routine Lab Inverted Microscopes

Your Preferred Inverted Microscope for Routine

ROUTINE IN UNIVERSITIES, LABS & INDUSTRIES

- » Wide range to fulfill specific lab requirements
- » Valuable solutions for life and material sciences
- » Compliant with several observation methods

AN AFFORDABLE PARTNER WITH HIGH-END FEATURES

- » IOS LWD W-PLAN objectives for flat images on 22 mm FN
- » Fast, efficient investigation with no particular sample prep
- » Trinocular port with beam splitter for most light-demanding needs



Optically Impressive

MAINTAINING GOOD EYESIGHT

- » 10x/22 eyepieces for large specimen view
- » Comfortable rubber cup to get rid of annoying external light
- » High eye-point for glasses wearers, dioptic adjustment (left eyepiece)

IM-3 & IOS W-PLAN: THE PERFECT COMBINATION

- » IOS Infinity corrected optical system
- » Full planarity optics on 22 mm (W-PLAN) according to ISO 19012-1
- » High-grade Semi-Apo lens available ideal for fluorescence

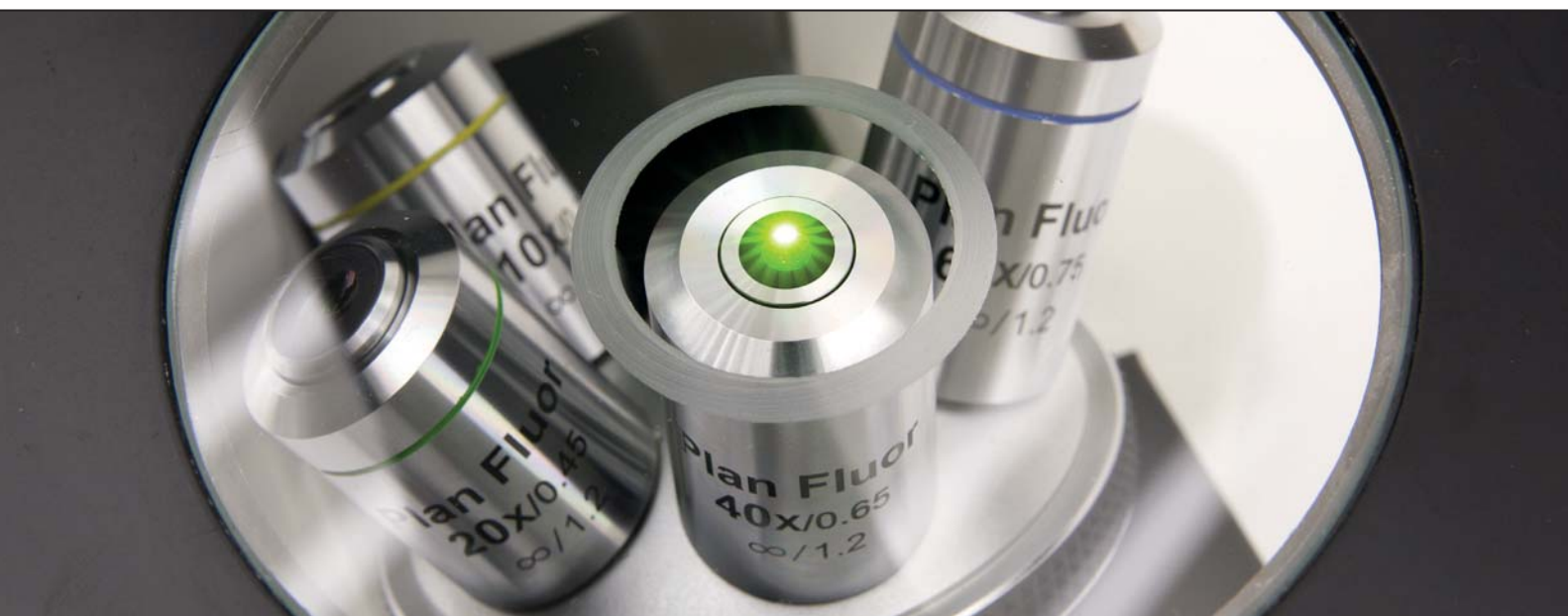

An Extensive Range of Different Configurations

OBSERVE EVEN THE MOST COMPLEX SAMPLES

- » Phase contrast lens for transparent sample examination
- » LED and HBO fluorescence available for specific purposes
- » High quality no cover glass objectives for material science

CONCEPTUAL INNOVATION IN LED FLUORESCENCE

- » Choose the lowest operational cost, LED lifetime of 65,000 hours
- » Immediate operation, eliminating warm-up/cool-down times
- » Forget about lamp centering, adjustment and maintenance

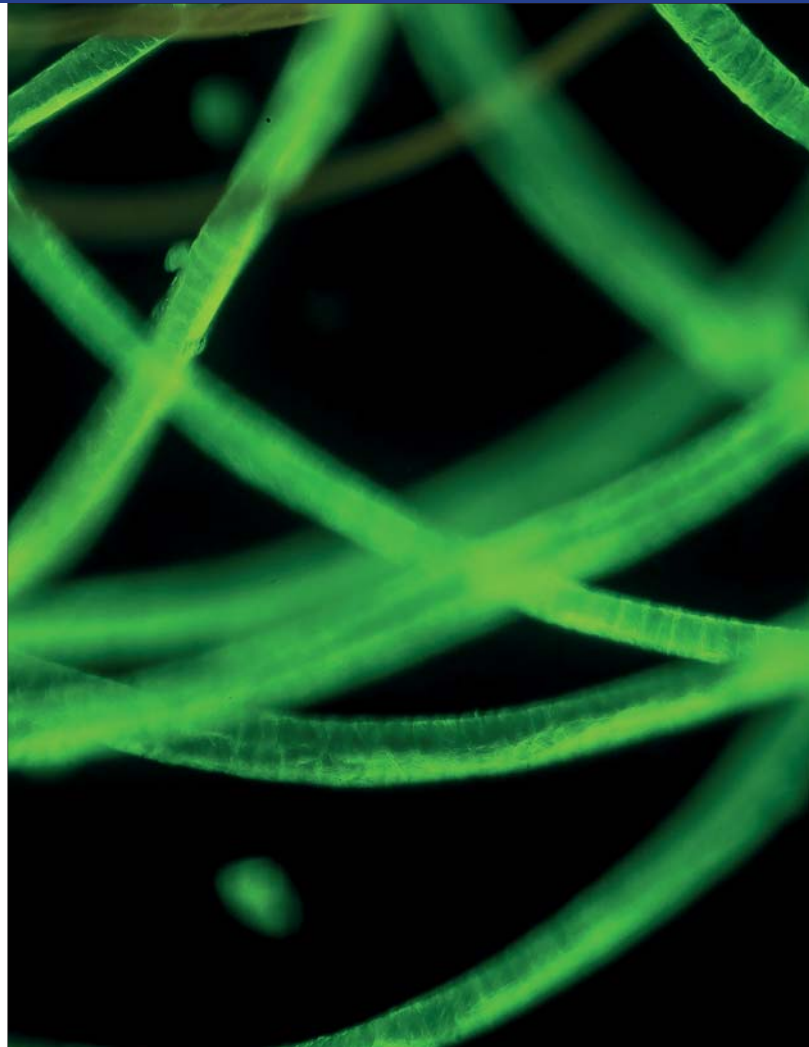
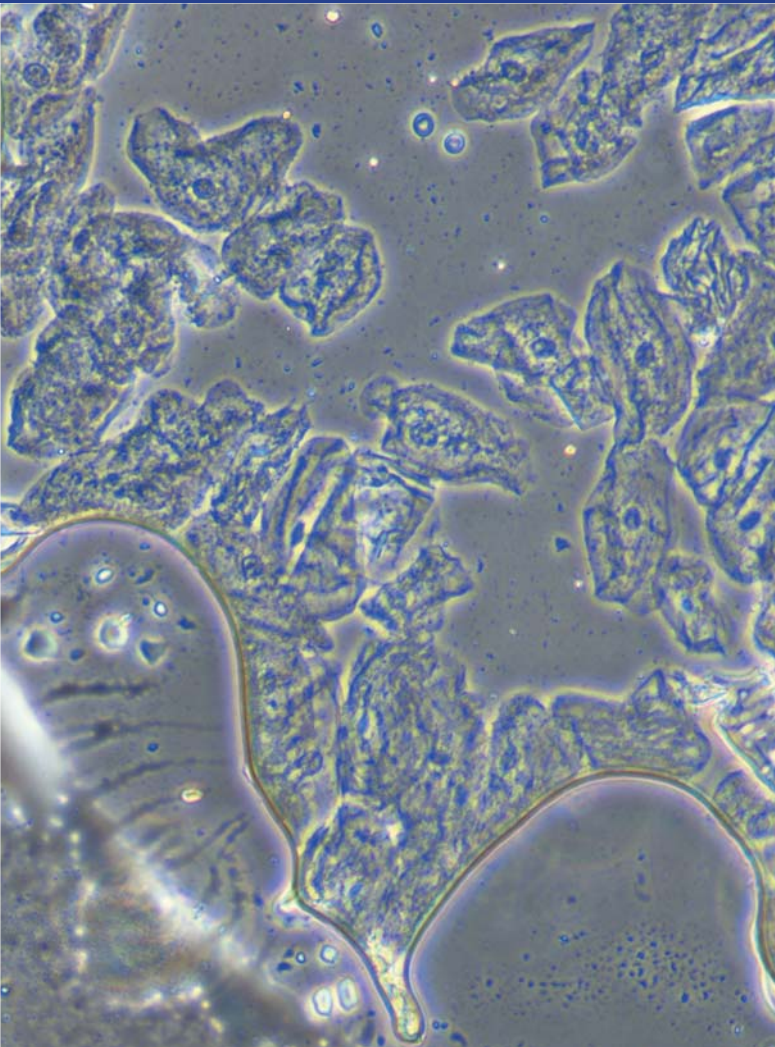

RPC - Relief Phase Contrast

RPC system is designed to increase visibility and contrast in unstained and living material by detecting optical gradients (or slopes) and converting them into variations of light intensity. Typical applications are transparent specimens, bacteria, tissue culture work, spermatozoa, cells in glass containers, protozoa, mites, fibers, etc.

When viewed under modulation contrast optics, transparent objects that are essentially invisible in ordinary brightfield microscopy take on an apparent three-dimensional appearance dictated by phase gradients in the specimen. There are also no halos exhibited in the image, unlike the images produced with phase contrast optics.

RPC is recommended over **DIC** technique in case of specimens like crystals (with effects upon polarized light), or contained in specimen carriers such as plastic culture vessels, Petri dishes, etc.

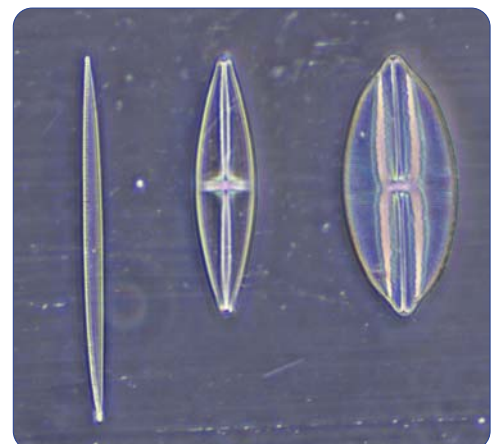

X-LED⁸ - Only Available at OPTIKA

STATE-OF-THE-ART ILLUMINATION SYSTEM

- » Uncomparable light intensity, exclusive lens & collector design
- » Constant pure-white color temperature at all intensity levels
- » Unmatched color fidelity, uniformity and brightness

CUT ELECTRICITY BILLS BY 90%

- » Money & energy saving, 8 W
- » More efficient brightness than a 100 W halogen lamp
- » LED long lifetime (65,000 hours = 22 years at 8 hours/day usage)



Multi-plug power supply

Go Digital - Vivid Colors & Contrast For Stunning Images

2

Laboratory

STAY CONNECTED WITH YOUR SPECIMEN, EASILY

- » Trinocular port to be always updated with the latest technology cameras, even in the future
- » Wide range of cameras matching all the needs, including the more specific ones
- » Modern C-mount focusable professional adapters for all kinds of cameras

PROFESSIONAL IMAGE ANALYSIS

- » Multi-language software for live-view, picture and video in different file formats
- » Advanced functions for pictures processing (EDF, stitching, multi-fluorescence combine)
- » Powerful tools to perform measurements and generate custom reports



Multiple Observation Methods

BRIGHTFIELD

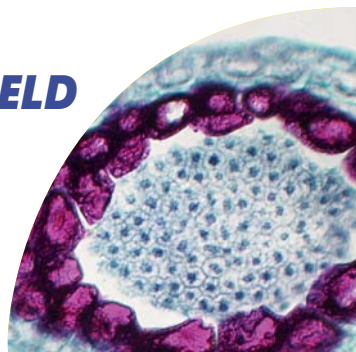

METALLOGRAPHY

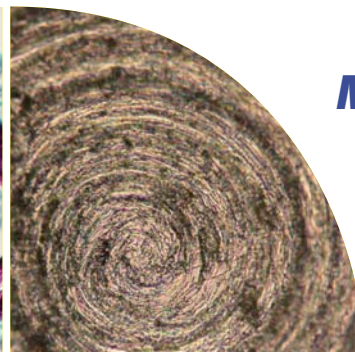

FLUORESCENCE



PHASE CONTRAST



IM-3 Series

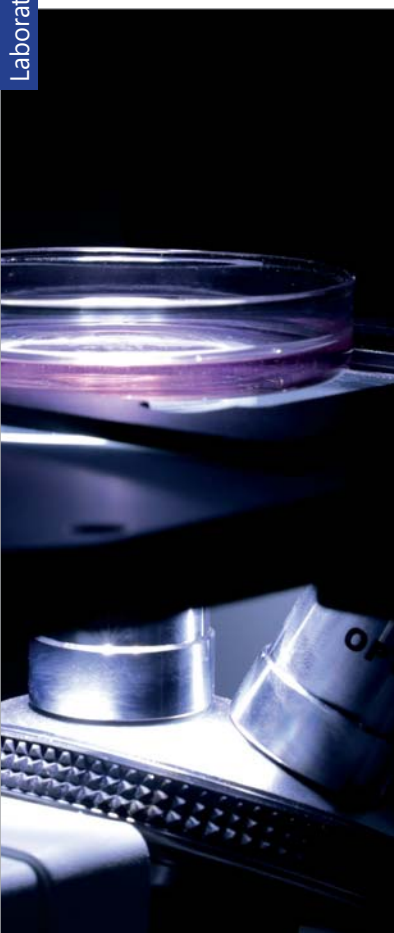

Inverted microscopes are useful for observing living cells or organisms at the bottom of a large container (e.g., a tissue culture flask) under more natural conditions than on a glass slide, as it occurs with a conventional microscope. IM-3 Series is engineered and designed to be your ideal solution for fast and reliable routine inspections, with the exclusive, state-of-the-art X-LED[®] illumination system. A particularly simple and ingenious optical design allows stable alignments and smooth and accurate movements. OPTIKA provides different configurations, including the innovative LED fluorescence technology for a new, enhanced experience.

X-LED[®] Exclusive Lighting Source

Special technology able to double the light intensity for incomparable performance, ensuring constant pure-white colour temperature (6,300K colour temperature).

Relevant money and energy saving thanks to the incredibly low energy consumptions which allows you to cut the electricity bills by 90%!

The electric consumption (8 W only) proves the high efficiency of this system: incredibly high light intensity combined with low consumption.

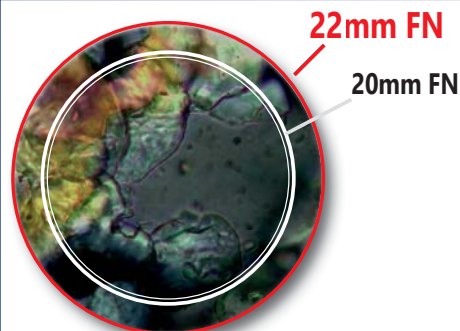

Large Specimen View (22 mm Field Number)

The **F.O.V.** (field of view) is based on a comfortable diameter of 22 mm.

This means that an extra wide area of the sample can be inspected and allows a natural and easy view, particularly needed in a laboratory environment.

In fluorescence we can offer several options.

According to your application and to the fluorochromes you are using, we can help you to identify the best light source.

Traditional, HBO Fluorescence

- » The most used and diffused method, worldwide
- » Wide spectrum range for future upgrades

Innovative, LED Fluorescence

- » Recommended for routine applications
- » Cost-effective, money saving technology
 - » Ready for immediate operation
 - » Eliminate warm-up/cool-down times
 - » Forget lamp replacement & centering

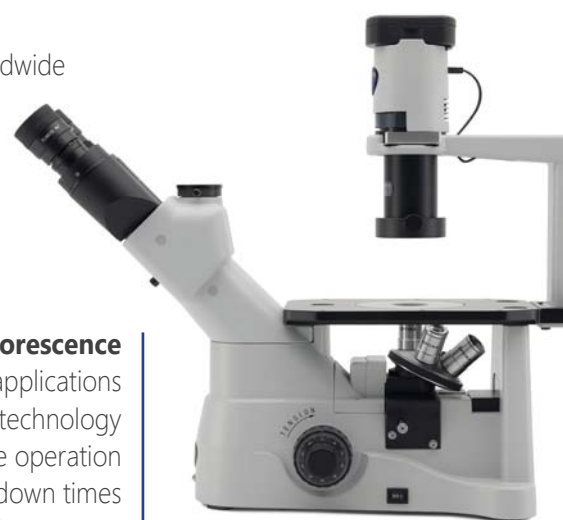

Routine Lab Inverted Microscopes

Get the most out of our accessories



DESIGNED TO FACILITATE YOUR DAILY ROUTINE

- » Removable condenser to increase the working distance
- » Mechanical stage and side extensions for great comfort (as optional)
- » Different inserts available according to the container used (as optional)



M-793.1
Holder for Petri diameter 38mm (M-793.2 needed).



M-793.2
Holder for Terasaki and Petri diameter 65mm.



M-793.3
Holder for slide and Petri diameter 54mm.



M-793.4
Holder for 2+2 slides.



M-793.5
Holder for metallurgical samples
(only for IM-3MET).



M-793.6
Holder for Utermöhl-Chamber (M-793.3 needed).



M-793.7
Load-bearing side extension.



M-792 (M-792.2 for IM-3LD2 only)
Mechanical stage.

IM-3 - Brightfield & Phase Contrast Microscope

IM-3 looks at the challenge of the future with confidence, offering first-class optical quality and mechanical versatility, to extend its use with several accessories. Ensuring top-level brightfield and phase contrast observation, as it comes with a set of 3 IOS LWD W-PLAN PH objectives (10x, 20x and 40x).

The high-efficiency **X-LED[®]** makes it reliable for all transmitted light observations.

For a more complete solution, choose among the several accessories available (objectives, translating stage, side extensions, holders and stage inserts).

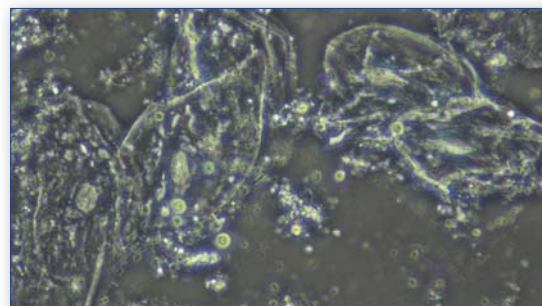

Part	Description
Observation mode:	Brightfield, phase contrast.
Head:	Trinocular (2-position 100/0, 50/50), 45° inclined.
Interpupillary distance:	Adjustable between 50 and 75 mm.
Dioptric adjustment:	On the left eyepiece tube.
Eyepieces:	WF10x/22 mm, high eye-point and with rubber cups.
Nosepiece:	Quintuple revolving nosepiece, rotation on ball bearings.
Objectives:	IOS LWD W-PLAN PH 10x/0.25 IOS LWD W-PLAN PH 20x/0.40 IOS LWD W-PLAN PH 40x/0.65 All with anti-fungus treatment.

Part	Description
Specimen stage:	Fixed stage, 250x160 mm, with glass and metal stage inserts.
Focusing:	Coaxial coarse (adjustable tension) and fine focusing mechanism with limit stop to prevent the contact between objective and specimen.
Condenser:	LWD pre-centered condenser, N.A. 0.30, W.D. 72 mm. With 4x/10x, 20x/40x phase contrast slider and brightfield. Removable to extend the working distance up to 150 mm.
Transmitted illumination:	X-LED [®] with white 8 W LED (6,300K) with brightness control. With aperture diaphragm. Multi-plug 100-240Vac/6Vdc external power supply.

IM-3F - HBO Fluorescence Microscope

Routine inverted fluorescence microscope for transmitted brightfield, phase contrast and fluorescence observations with IOS LWD W-PLAN objectives. The HBO fluorescence illuminator is combined with blue and green excitation filter set for the visualization of the following fluorochromes: Acridine Yellow, Acridine Orange, Auramine, DiO, DTAF, FITC, GFP, YFP, etc. (blue) plus Rhodamine, Texas Red and TRITC (green). Transmitted light through the exclusive **X-LED[®]** to ensure great-looking, rich and high-quality specimen view.

-  22
- 
- 
-  X-LED[®]
-  IOS
-  W-PLAN
-  FL
-  PH
- 

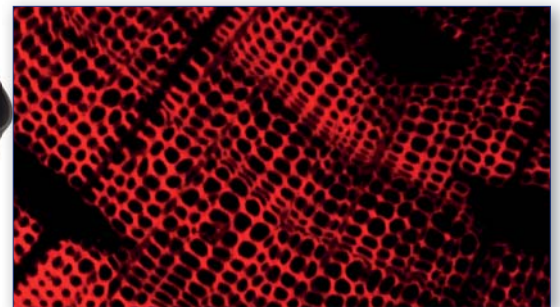
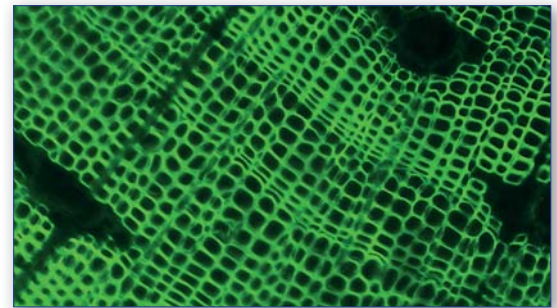

Standard filtersets

Name	Excitation filter (nm)	Dichroic mirror cut-off (nm)	Emission filter (nm)
B (Blue)	450 – 490	495	520LP
G (Green)	527 – 553	565	575LP



Part	Description
Observation mode:	Brightfield, phase contrast, HBO fluorescence.
Epi-illumination and filter:	HBO 100 W high pressure mercury lamp. 3-position filter holder; blue & green included.
Head:	Trinocular (2-position 100/0, 0/100), 45° inclined.
Interpupillary distance:	Adjustable between 50 and 75 mm.
Dioptric adjustment:	On the left eyepiece tube.
Eyepieces:	WF10x/22 mm, high eye-point and with rubber cups.
Nosepiece:	Quintuple revolving nosepiece, rotation on ball bearings.
Objectives:	IOS LWD W-PLAN 4x/0.13 IOS LWD W-PLAN PH 10x/0.25 IOS LWD W-PLAN PH 20x/0.40 IOS LWD W-PLAN 40X/0.60 All with anti-fungus treatment.

Part	Description
Specimen stage:	Fixed stage, 250x160 mm, with glass and metal stage inserts.
Focusing:	Coaxial coarse (adjustable tension) and fine focusing mechanism with limit stop to prevent the contact between objective and specimen.
Condenser:	LWD pre-centered condenser, N.A. 0.30, W.D. 72 mm. With 4x/10x, 20x/40x phase contrast slider and brightfield. Removable to extend the working distance up to 150 mm.
Transmitted illumination:	X-LED [®] with white 8 W LED (6,300K) with brightness control. With aperture diaphragm. Multi-plug 100-240Vac/6Vdc external power supply.

IM-3FL4 - HBO Fluorescence Microscope

Advanced inverted microscope for brightfield and fluorescence observations with Semi-Apo IOS LWD U-PLAN F objectives to enhance the visibility of the sample and increase the overall contrast. The HBO fluorescence illuminator provides an outstanding flexibility of use, standing the blue and green filter sets (supplied as standard) for Auramine, FITC, GFP and YFP (with blue filter set) plus Rhodamine, Texas Red and TRITC (with the green one), yet giving the possibility to combine any other specific filter sets for future upgrade. Transmitted light through the exclusive **X-LED⁸** to ensure great-looking, rich and high-quality specimen view.

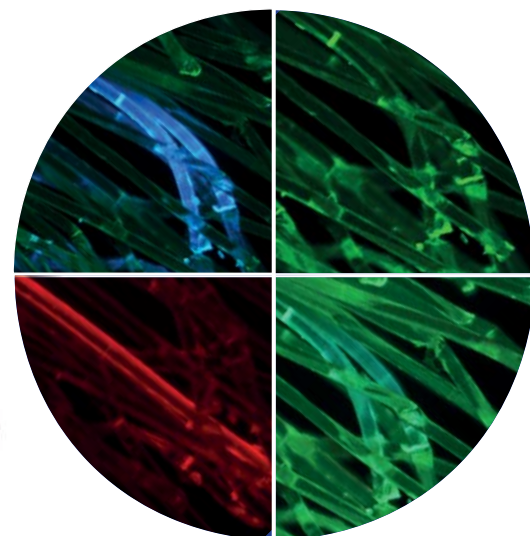

Standard filterset

Name	Excitation filter (nm)	Dichroic mirror cut-off (nm)	Emission filter (nm)
B Blue	460 - 490	500	520LP
G Green	527 - 553	565	575LP

Additional filterset (optional)

Name	Excitation filter (nm)	Dichroic mirror cut-off (nm)	Emission filter (nm)
V (Violet)	390 - 420	440	455LP
UV	325 - 375	415	435LP



Part	Description
Observation mode:	Brightfield, HBO fluorescence.
Epi-illumination and filter:	HBO 100 W high pressure mercury lamp. 4-position filter holder; blue & green included.
Head:	Trinocular (2-position 100/0, 0/100), 45° inclined.
Interpupillary distance:	Adjustable between 50 and 75 mm.
Dioptric adjustment:	On the left eyepiece tube.
Eyepieces:	WF10x/22 mm, high eye-point and with rubber cups.
Nosepiece:	Quintuple revolving nosepiece, rotation on ball bearings.
Objectives:	IOS LWD U-PLAN F 10x/0.30 IOS LWD U-PLAN F 20x/0.45 IOS LWD U-PLAN F 40x/0.65 All with anti-fungus treatment.

Part	Description
Specimen stage:	Fixed stage, 250x160 mm, with glass and metal stage inserts.
Focusing:	Coaxial coarse (adjustable tension) and fine focusing mechanism with limit stop to prevent the contact between objective and specimen.
Condenser:	LWD pre-centered condenser, N.A. 0.30, W.D. 72 mm. Removable to extend the working distance up to 150 mm.
Transmitted illumination:	X-LED ⁸ with white 8 W LED (6,300K) with brightness control. With aperture diaphragm. Multi-plug 100-240Vac/6Vdc external power supply.

IM-3LD2 - LED Fluorescence Microscope

Routine inverted fluorescence microscope for transmitted brightfield, phase contrast and fluorescence observations with IOS LWD W-PLAN PH objectives. The LED fluorescence illuminators are combined with blue and green excitation filter set for the visualization of the following fluorochromes: Acridine Yellow, Acridine Orange, Auramine, DiO, DTAF, FITC, GFP, YFP, etc. (blue) plus Rhodamine, Texas Red and TRITC (green). LED fluorescence ensures unparalleled convenience eliminating warm-up/cool-down times and all the inconveniences related lamp replacement and adjustment. Transmitted light through the exclusive **X-LED[®]** to ensure great-looking, rich and high-quality specimen view.

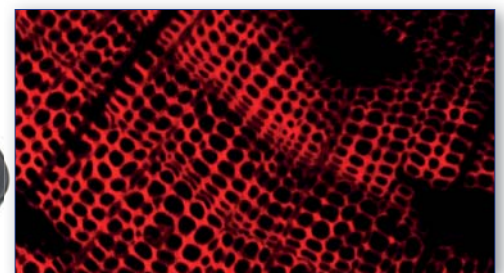
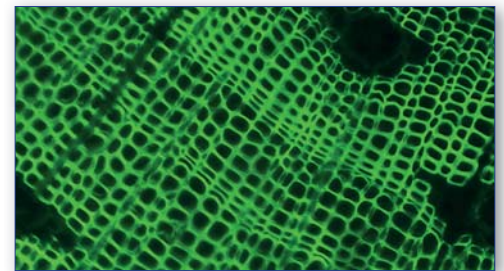

A new milestone achieved in Fluorescence Microscopy

- » 10% higher light intensity than HBO
- » 35% higher light intensity than Metal-Halide
- » Adjustable light intensity
- » The selection of filtersets automatically involves the switching on of the corresponding LEDs
- » Recommended for routine applications
- » Cost-effective, money saving technology
- » Ready for immediate operation
- » Eliminate warm-up/cool-down times
- » Forget lamp replacement & centering

LED Fluorescence Cubes (LED + Filterset) included

Name	LED emission (nm)	Excitation filter (nm)	Dichroic mirror cut-off (nm)	Emission filter (nm)
Blue	460	455 - 495	500	510LP
Green	523	510 - 550	570	575LP

Part	Description
Observation mode:	Brightfield, phase contrast, LED fluorescence.
Epi-illumination and filter:	High-power LED with brightness control. 3-position filter holder; blue and green filtersets included.
Head:	Trinocular (2-position 100/0, 50/50), 45° inclined.
Interpupillary distance:	Adjustable between 50 and 75 mm.
Dioptric adjustment:	On the left eyepiece tube.
Eyepieces:	WF10x/22 mm, high eye-point and with rubber cups.
Nosepiece:	Quintuple revolving nosepiece, rotation on ball bearings.
Objectives:	IOS LWD W-PLAN PH 10x/0.25 IOS LWD W-PLAN PH 20x/0.40 IOS LWD W-PLAN PH 40x/0.65 All with anti-fungus treatment.

Part	Description
Specimen stage:	Fixed stage, 250x160 mm, with glass and metal stage inserts. Mechanical stage as option.
Focusing:	Coaxial coarse (adjustable tension) and fine focusing mechanism with limit stop to prevent the contact between objective and specimen.
Condenser:	LWD pre-centered condenser, N.A. 0.30, W.D. 72 mm. With 4x/10x, 20x/40x phase contrast slider and brightfield. Removable to extend the working distance up to 150 mm.
Transmitted illumination:	X-LED [®] with white 8 W LED (6,300K) with brightness control. With aperture diaphragm. 100-240Vac/12Vdc external power supply.

IM-3LD4 - LED Fluorescence Microscope

Advanced fluorescence inverted microscope for transmitted brightfield and fluorescence observations with IOS LWD U-PLAN F objectives. The extremely powerful LED Fluorescence Illuminators are combined with corresponding excitation filter sets for the visualization of most fluorochromes. LED fluorescence ensures unparalleled convenience eliminating warm-up/cool-down times and all the inconveniences related lamp replacement and adjustment. Transmitted light through the exclusive **X-LED[®]** to ensure great-looking, rich and high-quality specimen view.



A new milestone achieved in Fluorescence Microscopy

- » Full-modular Fluorescence System
- » Interchangeable LED-Filtersets
- » 4 LED-Filtersets slots
- » 10% higher light intensity than HBO
- » 35% higher light intensity than Metal-Halide
- » Adjustable light intensity
- » The selection of filtersets automatically involves the switching on of the corresponding LEDs
- » Recommended for research applications
- » Cost-effective, money saving technology
- » Ready for immediate operation
- » Eliminate warm-up/cool-down times
- » Forget lamp replacement & centering

LED Fluorescence Cubes available (LED + Filterset)

Name	LED emission (nm)	Excitation filter (nm)	Dichroic mirror cut-off (nm)	Emission filter (nm)
M-1230 - Blue	460	455 - 495	500	510LP
M-1230.1 - Blue (pass band)	460	455 - 495	500	518-542
M-1231 - Green	523	510 - 550	570	575LP
M-1231.1 - Green (pass band)	523	510 - 550	570	585-625
M-1232 - Violet	405	390 - 420	440	450LP
M-1233 - UV	365	325 - 375	415	435LP
M-1233.1 - UV (pass band)	365	340 - 390	405	420-470
M-1234 - Red 1	623	590 - 650	660	665LP
M-1235 - Red 2	623	595 - 645	655	665 - 715
M-1236 - Deep Red	660	623 - 678	685	690 - 750
M-1237 - Far Red	740	720 - 760	770	780LP
M-1238 - Amber	590	582 - 603	610	615 - 645

Part	Description
Observation mode:	Brightfield, LED fluorescence.
Epi-illumination and filter:	High -Power LED with brightness control. 4-position filter holder; none included.
Head:	Trinocular (2-position 100/0, 50/50), 45° inclined.
Interpupillary distance:	Adjustable between 50 and 75 mm.
Dioptric adjustment:	On the left eyepiece tube.
Eyepieces:	WF10x/22 mm, high eye-point and with rubber cups.
Nosepiece:	Quintuple revolving nosepiece, rotation on ball bearings.
Objectives:	IOS LWD U-PLAN F 10x/0.30 IOS LWD U-PLAN F 20x/0.45 IOS LWD U-PLAN F 40x/0.65 All with anti-fungus treatment.

Part	Description
Specimen stage:	Mechanical stage, 250x290 mm, with glass and metal stage inserts for slides and 54mm dia. Petri dishes.
Focusing:	Coaxial coarse (adjustable tension) and fine focusing mechanism with limit stop to prevent the contact between objective and specimen.
Condenser:	LWD pre-centered condenser, N.A. 0.30, W.D. 72 mm. Removable to extend the working distance up to 150 mm.
Transmitted illumination:	X-LED [®] with white 8 W LED (6,300K) with brightness control. With aperture diaphragm. Multi-plug 100-240Vac/12Vdc external power supply.

IM-3LD4D - LED Fluorescence Microscope

Advanced fluorescence inverted microscope for transmitted brightfield and fluorescence observations with IOS LWD U-PLAN F objectives. The extremely powerful LED Fluorescence Illuminators are combined with corresponding excitation filter sets for the visualization of most fluorochromes. LED fluorescence ensures unparalleled convenience eliminating warm-up/cool-down times and all the inconveniences related lamp replacement and adjustment. Transmitted light through the exclusive **X-LED[®]** to ensure great-looking, rich and high-quality specimen view. This model is equipped with an Intel micro PC, a 12" screen, a 6Mpx high-sensitivity color camera, Optika ProView image analysis software for fluorescence and wireless mouse and keyboard.



A new milestone achieved in Fluorescence Microscopy

- » Full-modular Fluorescence System
- » Interchangeable LED-Filtersets
- » 4 LED-Filtersets slots
- » 10% higher light intensity than HBO
- » 35% higher light intensity than Metal-Halide
- » Adjustable light intensity
- » The selection of filtersets automatically involves the switching on of the corresponding LEDs
- » Recommended for research applications
- » Cost-effective, money saving technology
- » Ready for immediate operation
- » Eliminate warm-up/cool-down times
- » Forget lamp replacement & centering

LED Fluorescence Cubes available (LED + Filterset)

Name	LED emission (nm)	Excitation filter (nm)	Dichroic mirror cut-off (nm)	Emission filter (nm)
M-1230 - Blue	460	455 - 495	500	510LP
M-1230.1 - Blue (pass band)	460	455 - 495	500	518-542
M-1231 - Green	523	510 - 550	570	575LP
M-1231.1 - Green (pass band)	523	510 - 550	570	585-625
M-1232 - Violet	405	390 - 420	440	450LP
M-1233 - UV	365	325 - 375	415	435LP
M-1233.1 - UV (pass band)	365	340 - 390	405	420-470
M-1234 - Red 1	623	590 - 650	660	665LP
M-1235 - Red 2	623	595 - 645	655	665 - 715
M-1236 - Deep Red	660	623 - 678	685	690 - 750
M-1237 - Far Red	740	720 - 760	770	780LP
M-1238 - Amber	590	582 - 603	610	615 - 645

Part	Description
Observation mode:	Brightfield, LED fluorescence.
Epi-illumination and filter:	High -Power LED with brightness control. 4-position filter holder; none included.
Head:	Trinocular (2-position 100/0, 50/50), 45° inclined.
Interpupillary distance:	Adjustable between 50 and 75 mm.
Dioptric adjustment:	On the left eyepiece tube.
Eyepieces:	WF10x/22 mm, high eye-point and with rubber cups.
Nosepiece:	Quintuple revolving nosepiece, rotation on ball bearings.
Objectives:	IOS LWD U-PLAN F 10x/0.30 IOS LWD U-PLAN F 20x/0.45 IOS LWD U-PLAN F 40x/0.65 All with anti-fungus treatment.

Part	Description
Specimen stage:	Mechanical stage, 250x290 mm, with glass and metal stage inserts for slides and 54mm dia. Petri dishes.
Focusing:	Coaxial coarse (adjustable tension) and fine focusing mechanism with upper limit stop.
Condenser:	LWD pre-centered condenser, N.A. 0.30, W.D. 72 mm. Removable to extend the working distance up to 150 mm.
Transmitted illumination:	X-LED [®] with white 8 W LED (6,300K) with brightness control. With aperture diaphragm. Multi-plug 100-240Vac/12Vdc external power supply.
Digital equipment:	Intel micro PC with Image analysis software for Fluorescence. 12" screen; 6Mpx high-sensitivity color camera. Supplied with wireless mouse & keyboard.

IM-3MET- Metallurgical Microscope

Routine inverted microscope with IOS LWD U-PLAN MET objectives for material science and metallographic applications, combining a sturdy yet compact structure with dedicated components required in this field, like the NCG (no cover glass) objectives working without cover slide ideal for metallographic samples and other opaque specimens. A particularly simple and ingenious optical design allows stable alignments and smooth and accurate movements.

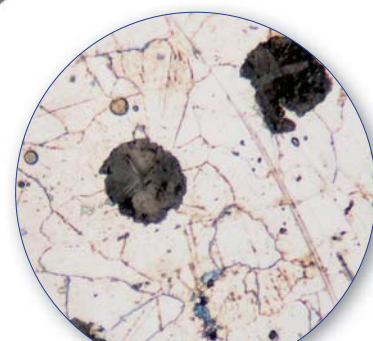

CAST IRON
BRIGHTFIELD

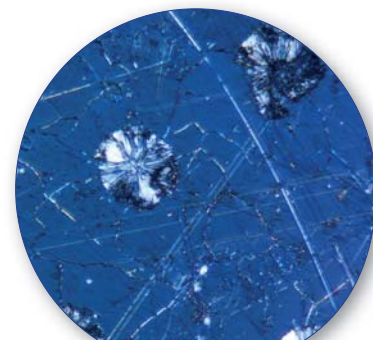

CAST IRON
POLARIZED LIGHT

Part	Description
Observation mode:	Brightfield, simple polarized light on incident light.
Epi-illumination and polarizing filters:	Halogen 12 V/50 W with brightness control. With aperture and field (centrable) diaphragms. With polarizer and analyzer.
Head:	Trinocular (2-position 100/0, 50/50), 45° inclined.
Interpupillary distance:	Adjustable between 50 and 75 mm.
Dioptric adjustment:	On the left eyepiece tube.
Eyepieces:	WF10x/22 mm, high eye-point and with rubber cups.
Nosepiece:	Quintuple revolving nosepiece, rotation on ball bearings.

Part	Description
Objectives:	IOS LWD U-PLAN MET 5x/0.15 IOS LWD U-PLAN MET 10x/0.30 IOS LWD U-PLAN MET 20x/0.45 IOS LWD U-PLAN MET 50x/0.55 All with anti-fungus treatment.
Specimen stage:	Fixed stage, 250x160 mm, with metal stage insert.
Focusing:	Coaxial coarse (adjustable tension) and fine focusing mechanism with limit stop to prevent the contact between objective and specimen.

IM-3METLD- Metallurgical Microscope

LED routine inverted microscope with IOS LWD U-PLAN MET objectives for material science and metallographic applications, combining a sturdy yet compact structure with dedicated components required in this field, like the NCG (no cover glass) objectives working without cover slide ideal for metallographic samples and other opaque specimens. A particularly simple and ingenious optical design allows stable alignments and smooth and accurate movements. This model is equipped with an 18W LED lighting system.



- 22
-
-
-
-
-

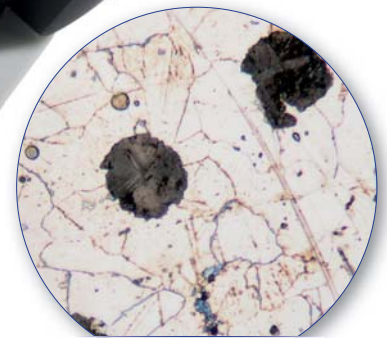

**CAST IRON
BRIGHTFIELD**

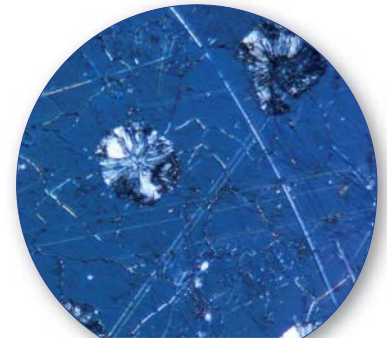

**CAST IRON
POLARIZED LIGHT**

Part	Description
Observation mode:	Brightfield, simple polarized light on incident light.
Epi-illumination and polarizing filters:	LED 18 W with brightness control. With aperture and field (centrable) diaphragms. With polarizer and analyzer.
Head:	Trinocular (2-position 100/0, 50/50), 45° inclined.
Interpupillary distance:	Adjustable between 50 and 75 mm.
Dioptric adjustment:	On the left eyepiece tube.
Eyepieces:	WF10x/22 mm, high eye-point and with rubber cups.
Nosepiece:	Quintuple revolving nosepiece, rotation on ball bearings.

Part	Description
Objectives:	IOS LWD U-PLAN MET 5x/0.15 IOS LWD U-PLAN MET 10x/0.30 IOS LWD U-PLAN MET 20x/0.45 IOS LWD U-PLAN MET 50x/0.55 All with anti-fungus treatment.
Specimen stage:	Fixed stage, 250x160 mm, with metal stage insert.
Focusing:	Coaxial coarse (adjustable tension) and fine focusing mechanism with limit stop to prevent the contact between objective and specimen.

IM-3 Series - Comparison chart

Common features:

- **Head:** Trinocular (2-position), 45° inclined.
- **Eyepieces:** WF10x/22mm, high eye-point.
- **Nosepiece:** Quintuple, reversed, on ball bearings.
- **Stage:** Fixed, 250x160 mm (mechanical stage and side extension available as accessories).
- **Focusing mechanism:** Coaxial coarse (adjustable tension) and fine focusing mechanism with limit stop to prevent the contact between objective and specimen.

Model	Type	Objectives	Condenser	Incident illumination	Fluorescence slider	Transmitted illumination
IM-3	BF, PH	IOS LWD W-PLAN PH 10x, 20x, 40x	LWD, N.A. 0.30, iris diaphragm	-	-	8 W X-LED [®] , brightness control
IM-3F	BF, FL, PH	IOS LWD W-PLAN 4x, 10xPH, 20PH, 40x	LWD, N.A. 0.30, iris diaphragm	FL HBO with blue and green filtersets	2-position +BF	8 W X-LED [®] , brightness control
IM-3FL4	BF, FL	IOS LWD U-PLAN F 10x, 20x, 40x	LWD, N.A. 0.30, iris diaphragm	FL HBO with blue and green filtersets	3-position +BF	8 W X-LED [®] , brightness control
IM-3LD2	BF, FL, PH	IOS LWD W-PLAN PH 10x, 20x, 40x	LWD, N.A. 0.30, iris diaphragm	FL LED with blue and green filtersets	2-position +BF	8 W X-LED [®] , brightness control
IM-3LD4	BF, FL	IOS LWD U-PLAN F 10x, 20x, 40x	LWD, N.A. 0.30, iris diaphragm	LED Fluorescence Cubes as optional	4-position	8 W X-LED [®] , brightness control
IM-3LD4D	BF, FL	IOS LWD U-PLAN F 10x, 20x, 40x	LWD, N.A. 0.30, iris diaphragm	LED Fluorescence Cubes as optional	2-position	8 W X-LED [®] , brightness control
IM-3MET	MET	IOS LWD U-PLAN MET 5x, 10x, 20x, 50x	-	Halogen bulb, 12 V/50 W, brightness control	-	-
IM-3METLD	MET	IOS LWD U-PLAN MET 5x, 10x, 20x, 50x	-	LED 18 W, brightness control	-	-

IM-3 Series - Optical performance

IM-3 / IM-3LD2 / IM-3F

Eyepiece		10x (M-780)		
Field number (mm)		22		
Objective	N.A.	W.D. (mm)	Total magnification	Field of view (mm)
4x	0.13	10.40	40x	5.50
10x PH	0.25	7.30	100x	2.20
20x PH	0.40	6.80	200x	1.10
40x PH	0.60	3.00	400x	0.55
60x	0.70	1.70	600x	0.37

IM-3FL4 / IM-3LD4 / IM-3LD4D

Eyepiece		10x (M-780)		
Field number (mm)		22		
Objective	N.A.	W.D. (mm)	Total magnification	Field of view (mm)
4x	0.13	18.52	40x	5.50
10x	0.30	7.11	100x	2.20
20x	0.45	5.91	200x	1.10
40x	0.65	1.61	400x	0.55
60x	0.75	1.04	600x	0.37

IM-3MET / IM-3METLD

Eyepiece		10x (M-780)			15x (M-601)	
Field number (mm)		22			16	
Objective	N.A.	W.D. (mm)	Total magnification	Field of view (mm)	Total magnification	Field of view (mm)
5x	0.15	10.80	50x	4.40	75x	3.20
10x	0.30	10	100x	2.20	150x	1.60
20x	0.45	4	200x	1.10	300x	0.80
50x	0.55	7.90	500x	0.44	750x	0.32
100x	0.80	2.10	1000x	0.22	1500x	0.16

IM-3 Series - Accessories

2

Laboratory

Eyecups & Eyepieces

- M-601 WF15x/16 eyepiece, high eyepoint
- M-780 PL10x/22 eyepiece, high eyepoint, with rubber cup
- M-781 PL10x/22 micrometric eyepiece, high eyepoint, with rubber cup

Objectives

IOS W-PLAN

- M-1049 IOS W-PLAN objective 2x/0.05
- M-782 IOS LWD W-PLAN objective 4x/0.10
- M-773 IOS LWD W-PLAN objective 40x/0.60
- M-786 IOS LWD W-PLAN objective 60x/0.70

IOS W-PLAN PH

- M-782.1 IOS LWD W-PLAN PH objective 4x/0.13
- M-783N IOS LWD W-PLAN PH objective 10x/0.25
- M-784N IOS LWD W-PLAN PH objective 20x/0.40
- M-785 IOS LWD W-PLAN PH objective 40x/0.65

IOS U-PLAN F

- M-800 IOS LWD U-PLAN F objective 4x/0.13
- M-801 IOS LWD U-PLAN F objective 10x/0.30
- M-802 IOS LWD U-PLAN F objective 20x/0.45
- M-803 IOS LWD U-PLAN F objective 40x/0.65
- M-804 IOS LWD U-PLAN F objective 60x/0.75

IOS U-PLAN F PH

- M-1177 IOS LWD U-PLAN F PH objective 20x/0.45
- M-1178 IOS LWD U-PLAN F PH objective 40x/0.65

IOS U-PLAN MET

- M-1100 IOS LWD U-PLAN MET objective 5x/0.15
- M-1101 IOS LWD U-PLAN MET objective 10x/0.30
- M-1102 IOS LWD U-PLAN MET objective 20x/0.45
- M-1103 IOS LWD U-PLAN MET objective 50x/0.55
- M-1104 IOS LWD U-PLAN MET objective 100x/0.80 (dry)

IOS LWD U-PLAN RPC

- M-861 IOS LWD U-PLAN RPC objective 4x/0.13
- M-862 IOS LWD U-PLAN RPC objective 10x/0.25
- M-863 IOS LWD U-PLAN RPC objective 20x/0.40
- M-864 IOS LWD U-PLAN RPC objective 40x/0.65

Attachments

- M-797 HBO fluo attachment, 2-pos. (B & G filter set), EU (only for IM-3)
- M-798 HBO fluo attachment, 4-pos. (B & G filter set), EU (only for IM-3)

Stages

- M-792 Mechanical stage
- M-792.2 Mechanical stage (for IM-3LD2 only)

Condensers & Filters

- M-676 Empty fluorescence filterblock (only for IM-3F)
- M-677 Fluorescence filter set V (filterblock included) (only for IM-3F)
- M-677.1 Fluorescence filter set V (filterblock NOT included) (only for IM-3F & IM-3FL4)
- M-677ND Neutral density filter, 25% transmission (only for IM-3F & IM-FL4)
- M-678 Fluorescence filter set UV-DAPI (filterblock included) (only for IM-3F)
- M-678.1 Fluorescence filter set UV-DAPI (filterblock NOT included) (only for IM-3F & IM-3FL4)
- M-678ND Neutral density filter, 50% transmission (only for IM-3F & IM-3FL4)
- M-1230 Blue LED Fluorescence Cube (LED+Filterset), for IM-3LD4
- M-1230.1 Blue (pass band)LED Fluorescence Cube (LED+Filterset), for IM-3LD4
- M-1231 Green LED Fluorescence Cube (LED+Filterset), for IM-3LD4
- M-1231.1 Green (pass band) LED Fluorescence Cube (LED+Filterset), for IM-3LD4
- M-1232 Violet LED Fluorescence Cube (LED+Filterset), for IM-3LD4
- M-1233 UV LED Fluorescence Cube (LED+Filterset), for IM-3LD4
- M-1233.1 UV (pass band) LED Fluorescence Cube (LED+Filterset), for IM-3LD4
- M-1234 Red 1 LED Fluorescence Cube (LED+Filterset), for IM-3LD4
- M-1235 Red 2 LED Fluorescence Cube (LED+Filterset), for IM-3LD4
- M-1236 Deep Red LED Fluorescence Cube (LED+Filterset), for IM-3LD4
- M-1237 Far Red LED Fluorescence Cube (LED+Filterset), for IM-3LD4
- M-1238 Amber LED Fluorescence Cube (LED+Filterset), for IM-3LD4

Camera Adapters

- M-113.1 Ring adapter, 30mm (for monocular and binocular microscopes)
- M-115 0.35x C-Mount projection lens
- M-114 0.5x C-Mount projection lens
- M-118 0.75x C-Mount projection lens
- M-173 C-Mount projection lens for APS-C/full frame reflex cameras (trino)
- M-620 0.35x focusable C-Mount adapter (biological microscopes)
- M-620.1 0.5x focusable C-Mount adapter (biological microscopes)
- M-620.2 0.65x focusable C-Mount adapter (biological microscopes)
- M-620.3 1x focusable C-Mount adapter (biological & stereomicroscopes)
- M-699 Universal adapter for C-Mount projection lens (trino)

Miscellaneous

- 15104 Cleaning kit
- DC-004 TNT dust cover, large, 700(l)x550(h) mm
- M-005 Micrometric slide, 26x76mm, with 2 scales (1mm/100 & 10mm/100)
- M-151 HBO 100W high-pressure mercury bulb for fluorescence (only for IM-3F & IM-3FL4)
- M-151.1 HBO 100W high-pressure mercury bulb for fluorescence (OSRAM) (only for IM-3F & IM-3FL4)
- M-622 Halogen bulb 12V/50W (only for IM-3MET)
- M-785.2N Slider with phase rings (4x/10x, 20x/40x, BF) (except for IM-3MET)
- M-793.1 Holder for Petri 38mm diameter (M-793.2 needed) (except for IM-3MET)
- M-793.2 Holder for Terasaki and Petri 65mm diameter (except for IM-3MET)
- M-793.3 Holder for slides and Petri 54mm diameter (except for IM-3MET)
- M-793.4 Holder for 2+2 slides (except for IM-3MET)
- M-793.5 Holder for metallurgical samples (only for IM-3MET)
- M-793.6 Holder for Utermohl-Chamber (M-793.3 needed) (except for IM-3MET)
- M-793.7 Load bearing side extension
- M-860 Slider with rotating 10x-20x-40x OPTIKA Modulation Contrast slit
- M-860.1 Slider with rotating 4x OPTIKA Modulation Contrast slit
- M-1004.N Centering telescope, 30mm diameter
- VP-IM3 IQ/OQ/PQ manual for IM-3 series
- AB-030 Antibacterial surface treatment, only for newly purchased microscope

15104 - Cleaning kit

It cleans glass quickly and effectively, without leaving residue or odor. Ideal for precision lens or prism cleaning.



How to connect the cameras to our microscopes.

Please refer to the Adapter reference list on Digital section.

v 6.7 - OPTIKA reserves the right to make corrections, modifications, enhancements, improvements and other changes to its products at any time without notice.

Headquarters and Manufacturing Facilities

OPTIKA® S.r.l. Via Rigla, 30 - 24010 Ponteranica (BG) - ITALY - Tel.: +39 035.571.392 - info@optikamicroscopes.com

Optika Sales branches

OPTIKA® Spain spain@optikamicroscopes.com

OPTIKA® China china@optikamicroscopes.com

OPTIKA® India india@optikamicroscopes.com

OPTIKA® USA usa@optikamicroscopes.com

OPTIKA® Central America camerica@optikamicroscopes.com

IM-5 Series



Routine & Research Lab Inverted Microscopes

The Best Option for Routine & Research

INTUITIVE YET SUPERIOR CONFIGURATIONS FOR PROFESSIONALS

- » Wide range to fulfil specific lab requirements
- » Valuable solutions for life and material sciences
- » Compliant with several observation methods

AN AFFORDABLE PARTNER WITH UNIQUE HIGH-END FEATURES

- » IOS LWD U-PLAN objectives for flat images on 24 mm FN
- » Fast, efficient investigation with no particular sample prep
- » Trinocular port with beam splitter for most light-demanding needs



Optically Impressive

MAINTAINING GOOD EYESIGHT

- » 10x/24 eyepieces for the highest F.O.V. on an inverted microscope
- » Comfortable rubber cup to get rid of annoying external light
- » High eye-point for glasses wearers and dioptic adjustment

IM-5 & IOS U-PLAN: THE PERFECT COMBINATION

- » IOS Infinity corrected optical system
- » Full planarity optics on 24 mm (U-PLAN) according to ISO 19012-1
- » High-grade Semi-Apo lens available ideal for fluorescence



An Extensive Range of Different Configurations

OBSERVE EVEN THE MOST COMPLEX SAMPLES

- » Phase contrast lens for transparent sample examination
- » Motorized LED fluorescence available for specific purposes
- » High quality no cover glass objectives for material science

AUTOMATIC LED SELECTION & CONCEPTUAL INNOVATION IN LED FLUORESCENCE

- » Choose the fluorescence filter for motorized LED selection
- » Immediate operation, eliminating warm-up/cool-down times
- » Forget about lamp centering, adjustment and maintenance

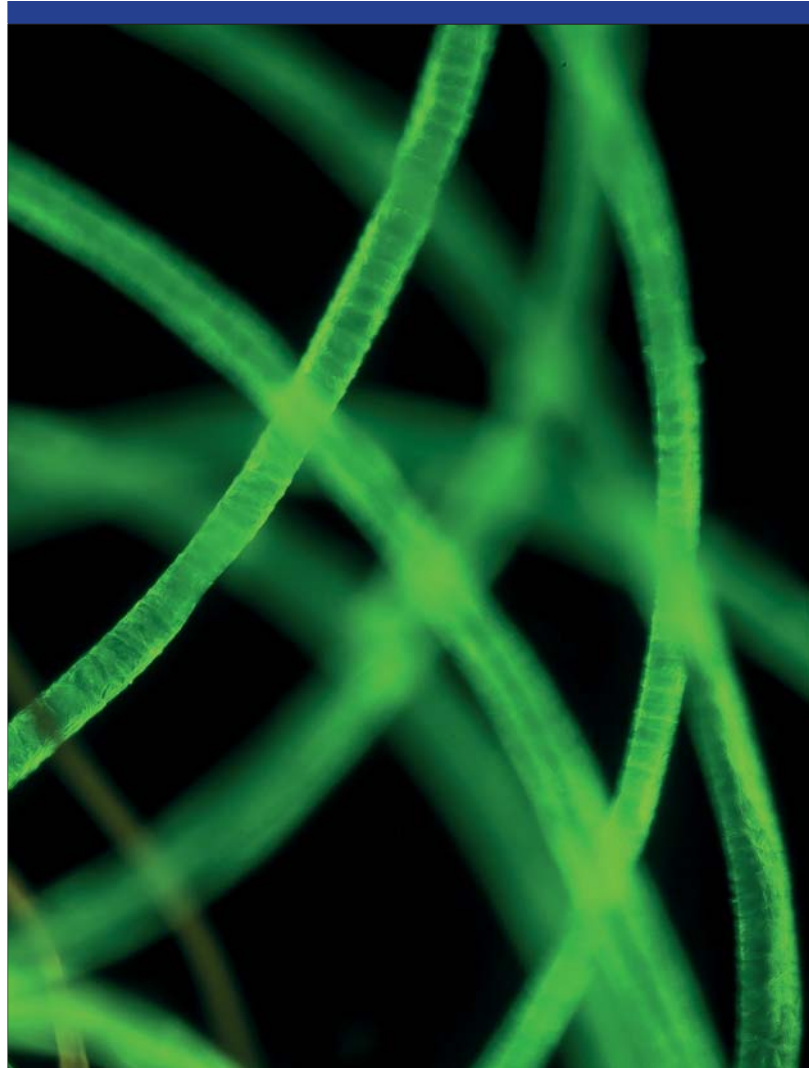
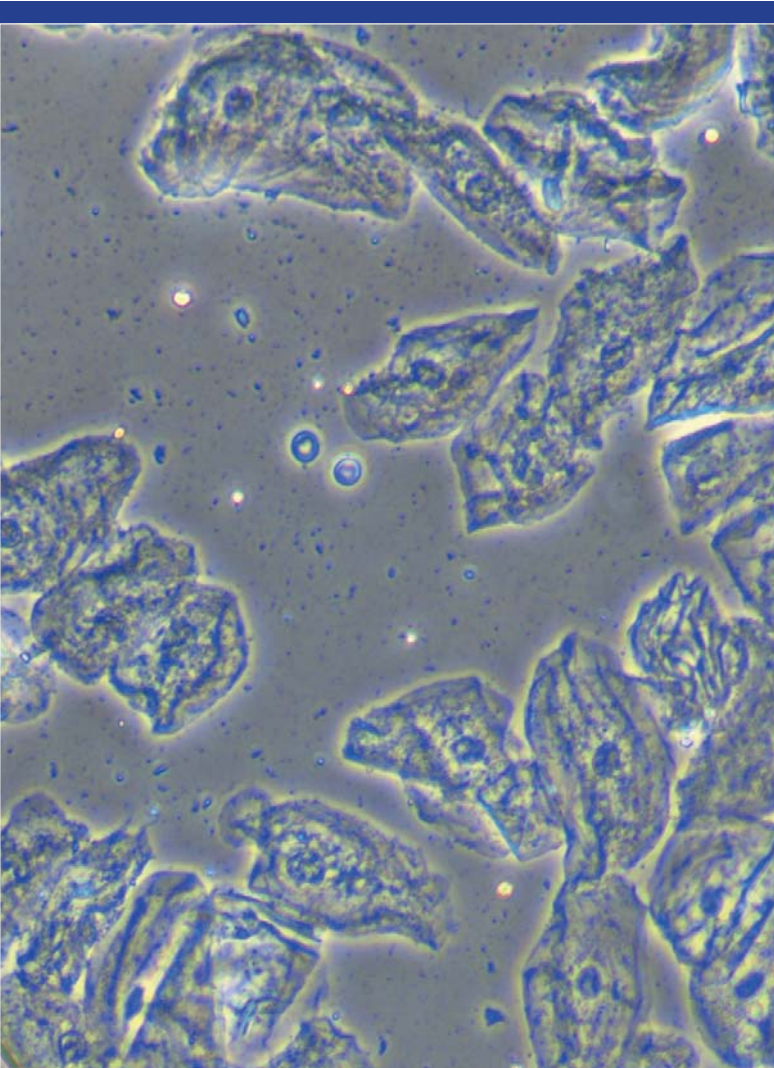

RPC Modulation Contrast

RPC system is designed to increase visibility and contrast in unstained and living material by detecting optical gradients (or slopes) and converting them into variations of light intensity. Typical applications are transparent specimens, bacteria, tissue culture work, spermatozoa, cells in glass containers, protozoa, mites, fibers, etc.

When viewed under modulation contrast optics, transparent objects that are essentially invisible in ordinary brightfield microscopy take on an apparent three-dimensional appearance dictated by phase gradients in the specimen. There are also no halos exhibited in the image, unlike the images produced with phase contrast optics.

RPC is recommended over **DIC** technique in case of specimens like crystals (with effects upon polarized light), or contained in specimen carriers such as plastic culture vessels, Petri dishes, etc.

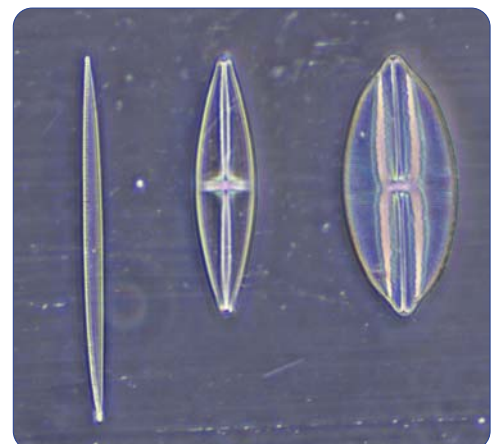

Born To Be Professional

DESIGNED TO FACILITATE YOUR DAILY ACTIVITIES

- » Mechanical stage and side extensions for great comfort
- » Large, resistant stage to easily and quickly process samples
- » Different inserts available according to the container used

CREATE YOUR COMPLETE, FLEXIBLE WORKING STATION

- » Integrable micromanipulation system available
- » Hoffman® modulation contrast available
- » Stage top incubation system available



Go Digital - Vivid Colors & Contrast For Stunning Images

2

STAY CONNECTED WITH YOUR SPECIMEN, EASILY

- » Trinocular port to be always updated with the latest technology cameras, even in the future
- » Wide range of cameras matching all the needs, including the more specific ones
- » Modern C-mount focusable professional adapters for all kinds of cameras

PROFESSIONAL IMAGE ANALYSIS

- » Multi-language software for live-view, picture and video in different file formats
- » Advanced functions for pictures processing (EDF, stitching, multi-fluorescence combine)
- » Powerful tools to perform measurements and generate custom reports

Laboratory

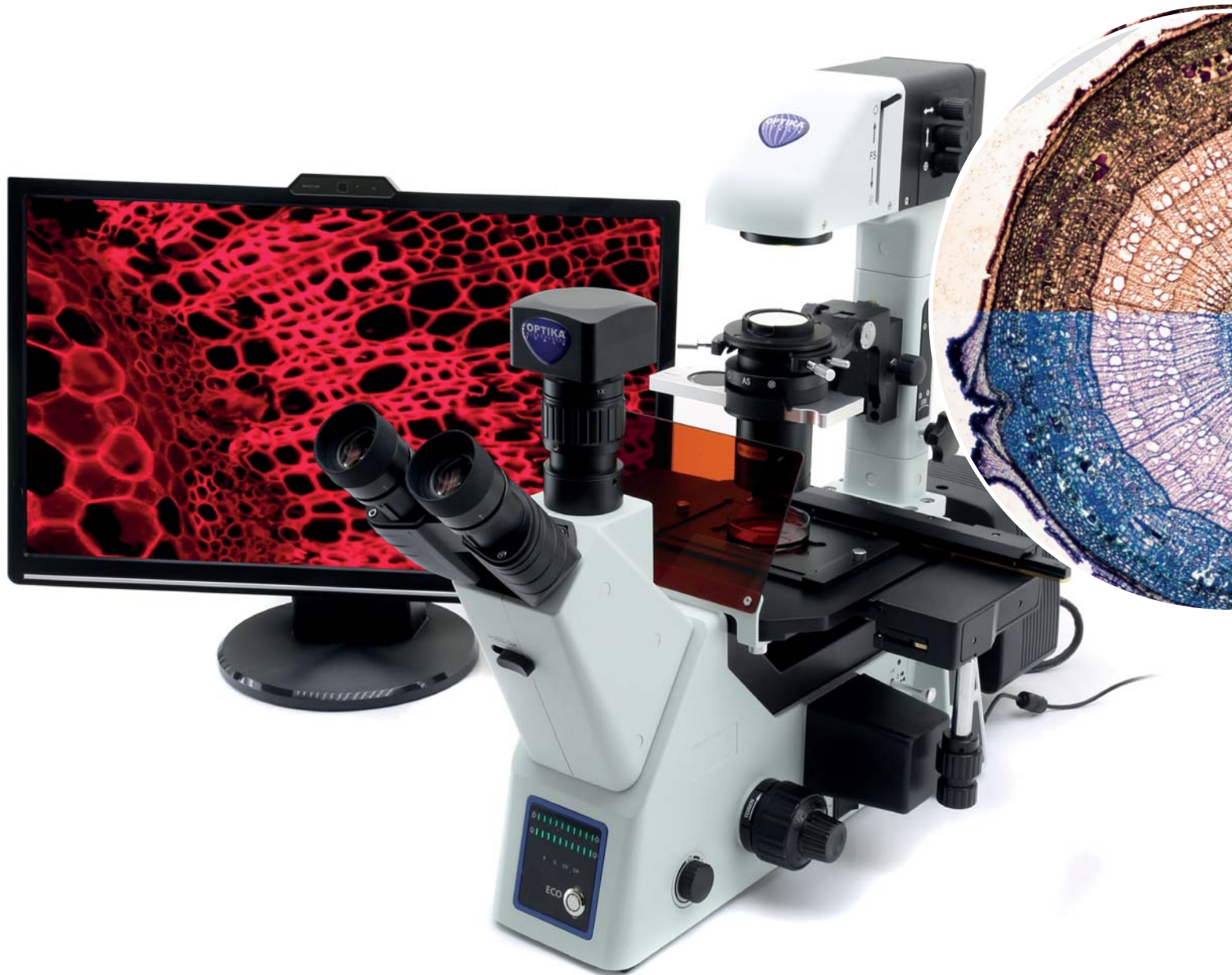

X-LED⁸ - Only Available at OPTIKA

STATE-OF-THE-ART ILLUMINATION SYSTEM

- » Uncomparable light intensity, exclusive lens & collector design
- » Constant pure-white color temperature at all intensity levels
- » Unmatched color fidelity, uniformity and brightness

CUT ELECTRICITY BILLS BY 90%

- » Money & energy saving, 8 W (on X-LED⁸)
- » More efficient brightness than a 100 W (for X-LED⁸) halogen lamp
- » LED long lifetime (65,000 hours = 22 years at 8 hours/day usage)



Adjust It To Your Individual Needs

FULLY SETTABLE, ADJUSTABLE IN HEIGHT CONDENSER FOR PERFECT IMAGING

- » Full Koehler illumination for enhanced images
- » Field & aperture diaphragms, centrable; N.A. 0.50 condenser
- » Removable/rotatable condenser to increase the working distance

IMPROVED OPTICAL PERFORMANCE, LONG WORKING DISTANCE

- » Superior image quality, crisp and bright details
- » Excellent contrast and resolution due to high numerical apertures
- » Comprehensive range of objectives for extended versatility



IM-5 Series

BRIGHTFIELD

Transmitted brightfield illumination is one of the most commonly used observation method in optical microscopy, and is ideal for fixed, stained specimens or other types of samples having high natural absorption of visible light.

IM-3 Series is fitted with high-efficiency LED brightfield illuminator, for the best outcome when using this technique.

Capsella middle embryo - IM-3 - Brightfield

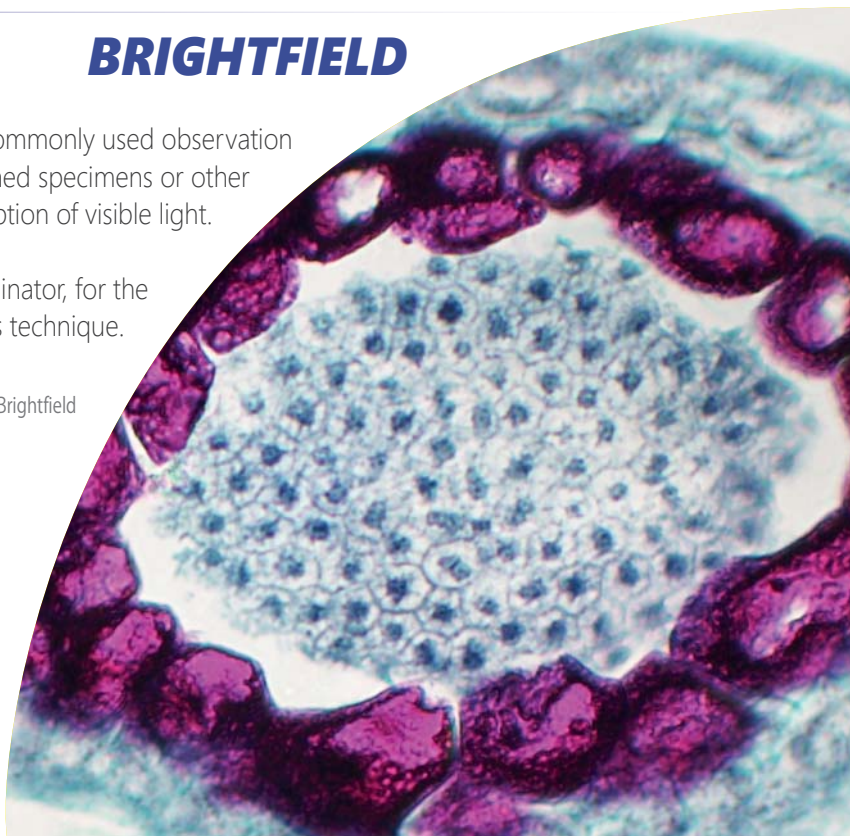

FLUORESCENCE

The fluorescence microscopy is the most demanding technique in biology and biomedical sciences, as well as in materials science.

This method is capable to study organic and inorganic samples thanks to primary fluorescence (auto-fluorescence) or secondary (staining and labelling with fluorochromes)

IM-Series is tailored for applications in research, clinical and pharmaceutical diagnostic field.

Fluorescence illuminators available as mercury lamp (IM-3F & IM-3FL4) and also as LED (IM-3LD).

Cotton fibers - IM-3FL4 - UV Fluorescence

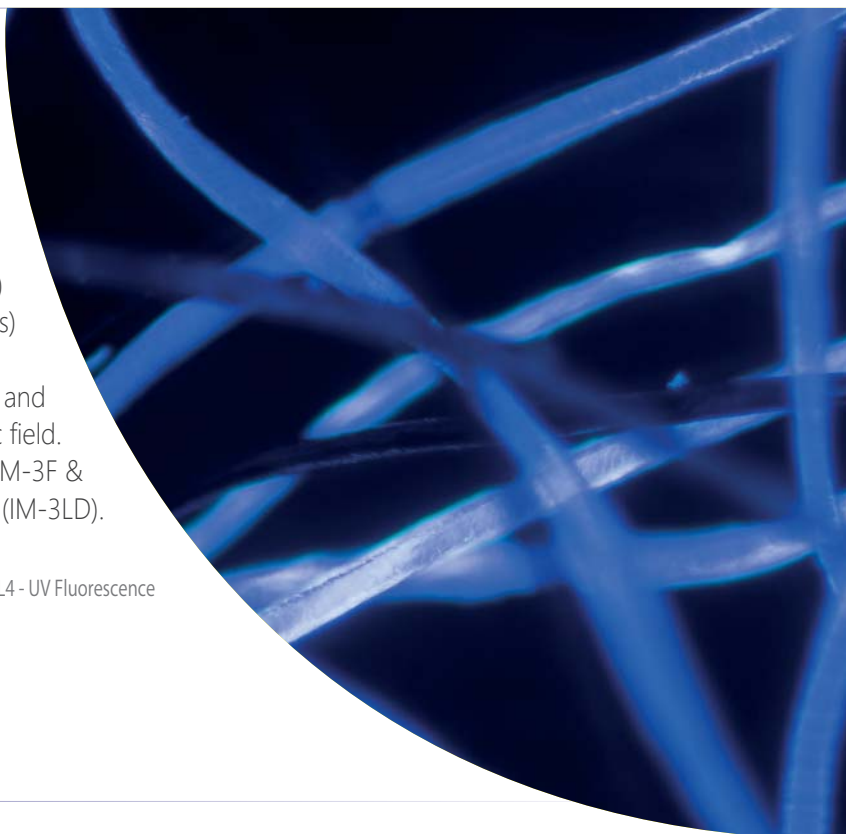

Multiple Observation Methods

MATERIAL SCIENCE / METALLOGRAPHY

Reflected light microscopy is the method for observation of specimens that remain opaque even when ground to a thickness of few microns. The range of specimens falling into this category is incredibly wide and includes most metals, ores, ceramics, many polymers, semiconductors (unprocessed silicon, wafers, and integrated circuits), coal, plastics, paint, paper, wood, leather, glass inclusions, and a wide variety of specific materials.

Brass (not polished) - IM-3MET - Material Science

PHASE CONTRAST

Phase-contrast microscopy is a particular technique applied in transparent, non-stainable, samples like culture of living cells, microorganisms, lithographic patterns, latex dispersions, fibers, asbestos and subcellular particles.

It reveals many cellular structures that are not visible with a simple brightfield microscope.

Diatoms - IM-3 - Phase contrast

IM-5 Series

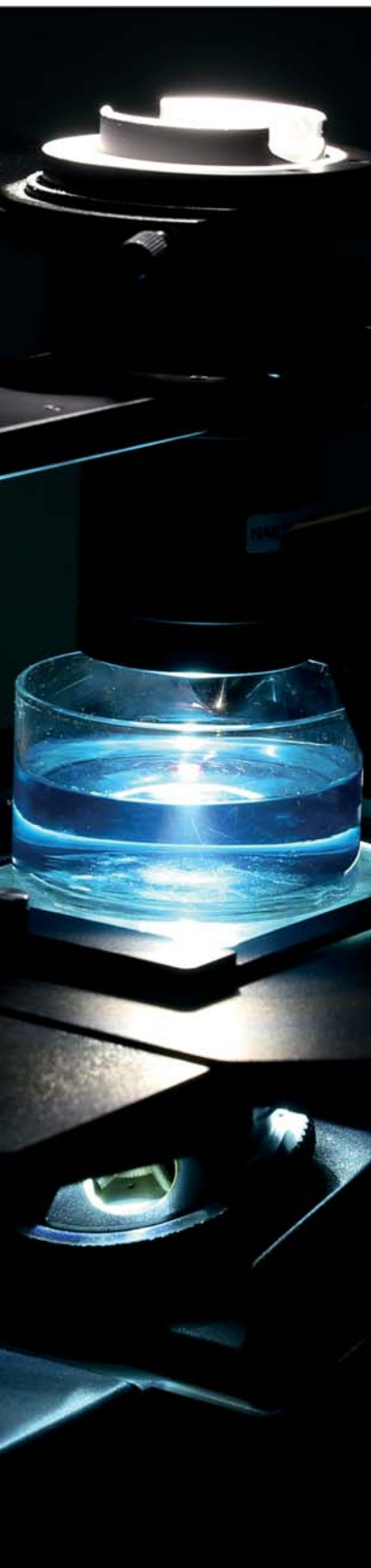

Significant Time And Money Saving

The IM-5 Series has been designed to increase comfort and achieve significant benefits, especially in terms of time saving with quick and intuitive installation, pre-aligned phase contrast system and pre-aligned LED light source.

As time is money, these features bring to a drastic impact on cost reduction, even more evident thanks to the exclusive illumination system provided by OPTIKA.

X-LED[®] Exclusive Lighting Source

Special technology able to double the light intensity for incomparable performance, ensuring constant pure-white colour temperature (6,300K colour temperature).

Relevant money and energy saving thanks to the incredibly low energy consumptions which allows you to cut the electricity bills by 90%!

The electric consumption (8 W) proves the high efficiency of this system: incredibly high light intensity combined with low consumption.

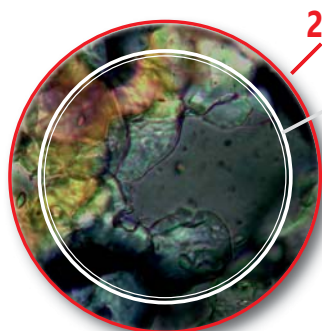

24mm FN

22mm FN

The Widest Specimen Area Available (24mm Field Number)

The **F.O.V.** (field of view) is based on a very comfortable diameter of 24 mm.

This means that an extra wide area of the sample can be inspected and allows a natural and easy view, particularly needed in a laboratory environment.

Panel With LED Illumination Indicator And ECO Function

IM-5 ensures significant repeatability since the level of light intensity can be seen at any time from the frontal panel in order to reproduce the same conditions. "ECO" button makes the microscope more environmentally sensitive, with automatic switch-off after 20 minutes of inactivity.



Routine & Research Lab Inverted Microscopes

In fluorescence we offer the latest technology.

IM-5FLD is a state-of-the art LED fluorescence microscope, equipped with motorized selection of the best LED according to the filter selected (blue, green, UV and an empty position fo optional filter) by using the filter holder slide.

Innovative, LED Fluorescence

- » Cost-effective, money saving technology
- » Ready for immediate operation
- » Eliminate warm-up/cool-down times
- » Forget lamp replacement & centering



Get the most out of our accessories



M-793.4
Holder for 2+2 slides.
(Only for IM-5 and IM-5FLD)



M-793.5
Holder for small metallurgical samples.
(Only for IM-5MET)



M-793.6
Holder for Utermöhl-Chamber.
(Only for IM-5 and IM-5FLD)

Accessories included



Holder for Petri diameter 38mm.
(Included with IM-5 and IM-5FLD)



Holder for Terasaki and Petri
diameter 65mm.
(Included with IM-5 and IM-5FLD)



Holder for slide and Petri
diameter 54mm.
(Included with IM-5 and IM-5FLD)

IM-5 - Brightfield & Phase Contrast Microscope

Phase contrast, brightfield and darkfield (dry) trinocular inverted microscope ideal for laboratory requirements (especially cell culture), with freely configurable lenses according to customer's preferences, FN 24 high eyepoint, infinity corrected optical system, coaxial focusing, mechanical stage, Abbe condenser and powerful, uniform, white color temperature 8 W **X-LED[®]**. Sturdy and incredibly reliable, it is equipped with all the main controls in ergonomic position and with long lasting LED illumination to provide over 20 years of use.



IM-5 - Specifications



Part	Description
Head:	Trinocular (fixed 50/50), 45° inclined.
Dioptric adjustment:	Both eyepieces.
Eyepieces:	WF10x/24 mm, high eyepoint and with retractable rubber cups.
Nosepiece:	Quintuple ball bearings revolving nosepiece, reversed.
Objectives:	Selectable according to customer's preferences. All with anti-fungus treatment.
Specimen stage:	Fixed stage, 215x250 mm and attachable mechanical stage, 290x250 mm, 120x80 mm X-Y movement range.
Focusing:	Coaxial coarse and fine focusing mechanism with limit stop to prevent the contact between objective and specimen. Adjustable tension of coarse focusing knob.
Condenser:	Abbe N.A. 0.50, removable, with iris diaphragm and slider for phase contrast.
Transmitted illumination (Full Koehler):	X-LED [®] with white 8 W LED and brightness control. Color temperature: 6,300 K. Multi-plug 100-240Vac/12Vdc external power supply.

IM-5 is freely configurable in terms of objectives, by choosing among:

Included ■ Optional □

Infinity-corrected Plan-Achromatic, Long Working Distance objectives, field flatness up to F.N. 22:

M-782	IOS LWD W-PLAN objective 4x/0.13	□
M-773	IOS LWD W-PLAN objective 40x/0.60	□
M-786	IOS LWD W-PLAN objective 60x/0.70	□

Positive Phase Contrast Infinity-corrected Plan-Achromatic, Long Working Distance objectives, field flatness up to F.N. 22:

M-782.1	IOS LWD W-PLAN PH objective 4x/0.13	□
M-783N	IOS LWD W-PLAN PH objective 10x/0.25	□
M-784N	IOS LWD W-PLAN PH objective 20x/0.40	□
M-785	IOS LWD W-PLAN PH objective 40x/0.65	□

Infinity-corrected Semi-Apochromatic, Long Working Distance objectives, field flatness up to F.N. 25:

M-800	IOS LWD U-PLAN F objective 4x/0.13	□
M-801	IOS LWD U-PLAN F objective 10x/0.30	□
M-802	IOS LWD U-PLAN F objective 20x/0.45	□
M-803	IOS LWD U-PLAN F objective 40x/0.65	□
M-804	IOS LWD U-PLAN F objective 60x/0.75	□

Positive Phase Contrast Infinity-corrected Semi-Apochromatic, Long Working Distance objectives, field flatness up to F.N. 25:

M-1177	IOS LWD U-PLAN F PH objective 20x/0.45	□
M-1178	IOS LWD U-PLAN F PH objective 40x/0.65	□

IM-5FLD - LED Fluorescence Microscope

Phase contrast, brightfield and darkfield (dry) LED fluorescence trinocular inverted microscope, with freely configurable lenses according to customer's preferences, FN 24 high eyepoint, infinity corrected optical system, coaxial focusing, mechanical stage, Abbe condenser and powerful, uniform, white color temperature 8 W **X-LED8**. The 4-position epi-fluorescence attachment is powered by extremely powerful 5 W LEDs fluorescence illuminator and combined with blue, green and UV excitation filters for the visualization of the following fluorochromes: Acridine Yellow, Acridine Orange, Auramine, DiO, DTAF, FITC, GFP, YFP (blue filter) plus Rhodamine, Texas Red and TRITC (green filter) plus Alexa Fluor® 350, 7- Amino-4-methylcoumarin, 6-Aminoquinoline, Calcofluor® White, Dansyl cadaverine, DAPI, Dapoxyl, DIDS, Europium (III) Chloride, Fluoro-Gold™, Fura-2, Hoechst 33342 & 33258, 1,5 IAEDANS, Indo-1, Marina Blue®, 4-Methylumbelliferone, PBF1, Pyrene, SBF1, Y66F, Y66H (UV filter) among the others. LED fluorescence ensures unparalleled convenience eliminating warm-up/cool-down times and all the inconveniences related lamp replacement and adjustment. Sturdy and incredibly reliable, it is equipped with all the main controls in ergonomic position and with long lasting, efficient LED illumination to provide over 20 years of use.



IM-5FLD - Specifications



Part	Description
Head:	Trinocular (split ratio: 100/0, 0/100), 45° inclined.
Dioptric adjustment:	Both eyepieces.
Eyepieces:	WF10x/24 mm, high eyepoint and with retractable rubber cups.
Epi-fluorescence illumination & filters:	High-power 5 W LEDs with brightness control, motorized LED selection with centrable field diaphragm, 4-position filter holder; blue (EX 450-490, DM 495, EM 500-550), green (EX 540-580, DM 585, EM 608-682) and UV (EX 340-390, DM 400, EM 420LP) excitation filters included.
Nosepiece:	Quintuple ball bearings revolving nosepiece, reversed.
Objectives:	Selectable according to customer's preferences. All with anti-fungus treatment.
Specimen stage:	Fixed stage, 215x250 mm and attachable mechanical stage, 290x250 mm, 120x80 mm X-Y movement range.
Focusing:	Coaxial coarse and fine focusing mechanism with limit stop to prevent the contact between objective and specimen. Adjustable tension of coarse focusing knob.
Condenser:	Abbe N.A. 0.50, removable, with iris diaphragm and slider for phase contrast.
Transmitted illumination (Full Koehler):	X-LED [®] with white 8 W LED and brightness control. Color temperature: 6,300 K. Multi-plug 100-240Vac/12Vdc external power supply.

Fluorescence filtersets

Name	Excitation filter (nm)	Dichroic mirror cut-off (nm)	Emission filter (nm)
B (Blue)	450 – 490	495	500 - 550
G (Green)	540 – 580	585	607 - 682
UV (Ultraviolet)	340 -390	400	420LP

IM-5FLD is freely configurable in terms of objectives, by choosing among:

Included ■ Optional □

Infinity-corrected Plan-Achromatic, Long Working Distance objectives, field flatness up to F.N. 22:		
M-782	IOS LWD W-PLAN objective 4x/0.13	□
M-773	IOS LWD W-PLAN objective 40x/0.60	□
M-786	IOS LWD W-PLAN objective 60x/0.70	□

Infinity-corrected Semi-Apochromatic, Long Working Distance objectives, field flatness up to F.N. 25:		
M-800	IOS LWD U-PLAN F objective 4x/0.13	□
M-801	IOS LWD U-PLAN F objective 10x/0.30	□
M-802	IOS LWD U-PLAN F objective 20x/0.45	□
M-803	IOS LWD U-PLAN F objective 40x/0.65	□
M-804	IOS LWD U-PLAN F objective 60x/0.75	□

Positive Phase Contrast Infinity-corrected Plan-Achromatic, Long Working Distance objectives, field flatness up to F.N. 22:		
M-782.1	IOS LWD W-PLAN PH objective 4x/0.13	□
M-783N	IOS LWD W-PLAN PH objective 10x/0.25	□
M-784N	IOS LWD W-PLAN PH objective 20x/0.40	□
M-785	IOS LWD W-PLAN PH objective 40x/0.65	□

Positive Phase Contrast Infinity-corrected Semi-Apochromatic, Long Working Distance objectives, field flatness up to F.N. 25:		
M-1177	IOS LWD U-PLAN F PH objective 20x/0.45	□
M-1178	IOS LWD U-PLAN F PH objective 40x/0.65	□

IM-5MET - Metallurgical Microscope

Industrial and materials science inverted microscope especially designed for opaque specimens (including metals microstructure investigation and studies such as grain size, grain boundaries, phases, transformation, inclusions, and non-metals, as well as sample preparation and treatment) in metallography labs. Freely configurable lenses according to customer's preferences, FN 24 high eyepoint, infinity corrected optical system, coaxial focusing, mechanical stage, and epi-illumination attachment powered by halogen 12 V/100 W with brightness control. Sturdy and incredibly reliable, it is equipped with all the main controls in ergonomic position and with long lasting, efficient LED illumination to provide over 20 years of use.

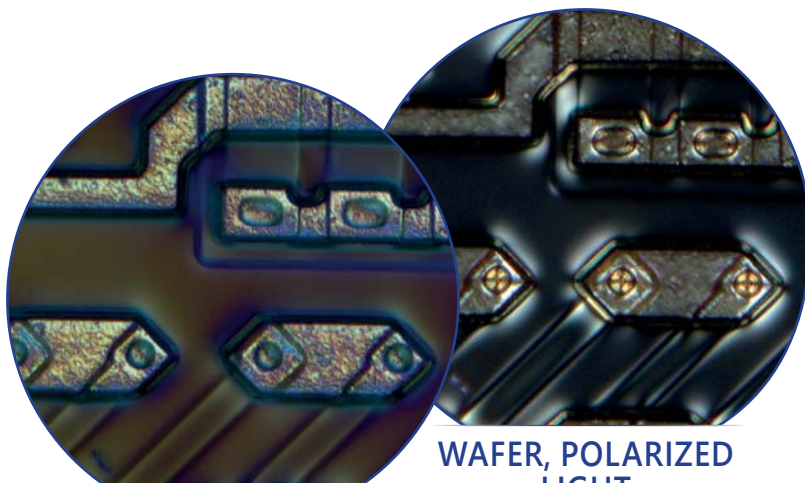

WAFER, DIC

WAFER, POLARIZED
LIGHT



IM-5MET - Specifications



Part	Description
Head:	Trinocular (split ratio: 100/0, 50/50), 45° inclined.
Dioptric adjustment:	Both eyepieces.
Eyepieces:	WF10x/24 mm, high eyepoint, secured by screw and with retractable rubber cups.
Epi-illumination & filters:	Halogen 12 V/100 W with brightness control. With field and aperture diaphragms, polarizer and analyzer filters.
Nosepiece:	Quintuple ball bearings revolving nosepiece, reversed.
Objectives:	Selectable according to customer's preferences. All with anti-fungus treatment.
Specimen stage:	Mechanical stage, 240x250 mm.
Focusing:	Coaxial coarse and fine focusing mechanism with limit stop to prevent the contact between objective and specimen. Adjustable tension of coarse focusing knob.

IM-5MET is freely configurable in terms of objectives, by choosing among:

Included ■ Optional □

MET Infinity-corrected Plan-Achromatic, Long Working Distance objectives, field flatness up to F.N. 25:		
M-1100	IOS LWD U-PLAN MET objective 5x/0.15	□
M-1101	IOS LWD U-PLAN MET objective 10x/0.30	□
M-1102	IOS LWD U-PLAN MET objective 20x/0.45	□
M-1103	IOS LWD U-PLAN MET objective 50x/0.55	□
M-1104	IOS LWD U-PLAN MET objective 100x/0.80 (dry)	□

MET Infinity-corrected Semi-Apochromatic, Long Working Distance objectives, field flatness up to F.N. 25:		
M-1171	IOS LWD U-PLAN F MET objective 5x/0.15	□
M-1172	IOS LWD U-PLAN F MET objective 10x/0.30	□
M-1173	IOS LWD U-PLAN F MET objective 20x/0.50	□
M-1174	IOS LWD U-PLAN F MET objective 50x/0.80	□
M-1175	IOS LWD U-PLAN F MET objective 100x/0.90 (dry)	□

MET Infinity-corrected Plan-Achromatic, Long Working Distance objectives, for brightfield and darkfield, field flatness up to F.N. 25:		
M-1094	IOS LWD U-PLAN MET BD objective 5x/0.15	□
M-1095	IOS LWD U-PLAN MET BD objective 10x/0.30	□
M-1096	IOS LWD U-PLAN MET BD objective 20x/0.45	□
M-1097	IOS LWD U-PLAN MET BD objective 50x/0.55	□
M-1098	IOS LWD U-PLAN MET BD objective 100x/0.80 (dry)	□

MET Infinity-corrected Semi-Apochromatic, Long Working Distance objectives, for brightfield and darkfield, field flatness up to F.N. 25:		
M-1180	IOS LWD U-PLAN F MET BD objective 5x/0.15	□
M-1181	IOS LWD U-PLAN F MET BD objective 10x/0.30	□
M-1182	IOS LWD U-PLAN F MET BD objective 20x/0.50	□
M-1183	IOS LWD U-PLAN F MET BD objective 50x/0.80	□
M-1184	IOS LWD U-PLAN F MET BD objective 100x/0.90 (dry)	□

IM-5 Series - Comparison Chart

Common features:

- **Head:** Trinocular (2-position 100/0, 0/100), 45° inclined.
- **Eyepieces:** PL10x/24 mm, with dioptic adjustment, high eye-point and rubber cups. Dioptic adjustment on both eyepieces.
- **Focusing mechanism:** Coaxial coarse (adjustable tension) and fine focusing mechanism with limit stop to prevent the contact between objective and specimen.

Model	Type	Nosepiece	Stage	Condenser	Incident illumination	Fluorescence slider	Transmitted illumination
IM-5	BF, PH	Quintuple revolving nosepiece, rotation on ball bearings	Fixed, 215x250 mm can be equipped with mechanical (included), 290x250 mm, 120x80 mm movement range	N.A. 0.50 Köhler, W.D. 28 mm, rotatable to extend the W.D.	-	-	8 W X-LED [®] , brightness control and ECO function
IM-5FLD	BF, FL, PH	Quintuple revolving nosepiece, rotation on ball bearings	Fixed, 215x250 mm can be equipped with mechanical (included), 290x250 mm, 120x80 mm movement range	N.A. 0.50 Köhler, W.D. 28 mm, rotatable to extend the W.D.	FL LED with Blue, Green and UV filtersets	4-position	8 W X-LED [®] , brightness control and ECO function
IM-5MET	BF MET, DF MET	Quintuple revolving nosepiece, rotation on ball bearings. With 26 mm thread holes, 5 adapter rings (for RMS objectives) and DIC slot	Rackless, mechanical, 240x250 mm, 50x50 mm movement range	-	Halogen bulb, 12 V/100 W, brightness control and ECO function	-	-



IM-5 Series - Optical Performance

Infinity-corrected Plan-Achromatic, Long Working Distance objectives, field flatness up to F.N. 22:

Eyepiece		10x (M-880)		
Field number		24 (mm)		
Objective	N.A.	W.D. (mm)	Total magnification	Field of view (mm)
4x	0.13	10.40	40x	6.0
40x	0.60	3.10	400x	0.60
60x	0.70	1.70	600x	0.40

Infinity-corrected Semi-Apochromatic, Long Working Distance objectives, field flatness up to F.N. 25:

Eyepiece		10x (M-880)		
Field number		24 (mm)		
Objective	N.A.	W.D. (mm)	Total magnification	Field of view (mm)
4x	0.13	18.52	40x	6.0
10x	0.30	7.11	100x	2.4
20x	0.45	5.91	200x	1.2
40x	0.65	1.61	400x	0.60
60x	0.75	1.04	600x	0.40

Positive Phase Contrast Infinity-corrected Plan-Achromatic, Long Working Distance objectives, field flatness up to F.N. 22:

Eyepiece		10x (M-880)		
Field number		24 (mm)		
Objective	N.A.	W.D. (mm)	Total magnification	Field of view (mm)
4x	0.13	10.40	40x	6.0
10x	0.25	7.30	100x	2.4
20x	0.40	6.80	200x	1.2
40x	0.60	3.00	400x	0.60

Positive Phase Contrast Infinity-corrected Semi-Apochromatic, Long Working Distance objectives, field flatness up to F.N. 25:

Eyepiece		10x (M-880)		
Field number		24 (mm)		
Objective	N.A.	W.D. (mm)	Total magnification	Field of view (mm)
20x	0.45	5.91	20x	1.2
40x	0.65	1.61	400x	0.60

MET Infinity-corrected Plan-Achromatic, Long Working Distance objectives, field flatness up to F.N. 25:

Eyepiece		10x (M-880)		
Field number		24 (mm)		
Objective	N.A.	W.D. (mm)	Total magnification	Field of view (mm)
5x	0.15	10.80	50x	4.8
10x	0.30	10.00	100x	2.40
20x	0.45	4.00	200x	1.20
50x	0.55	7.90	500x	0.48
100x	0.80	2.10	1000x	0.24

MET Infinity-corrected Semi-Apochromatic, Long Working Distance objectives, field flatness up to F.N. 25:

Eyepiece		10x (M-880)		
Field number		24 (mm)		
Objective	N.A.	W.D. (mm)	Total magnification	Field of view (mm)
5x	0.15	19.50	50x	4.8
10x	0.30	10.9	100x	2.40
20x	0.50	3.20	200x	1.20
50x	0.80	1.2	500x	0.48
1000x	0.90	1.00	1000x	0.24

MET Infinity-corrected Plan-Achromatic, Long Working Distance objectives, for brightfield and darkfield, field flatness up to F.N. 25:

Eyepiece		10x (M-880)		
Field number		24 (mm)		
Objective	N.A.	W.D. (mm)	Total magnification	Field of view (mm)
5x	0.15	9.00	50x	4.8
10x	0.30	9.00	100x	2.40
20x	0.45	3.40	200x	1.20
50x	0.55	7.50	500x	0.48
100x	0.80	2.00	1000x	0.24

MET Infinity-corrected Semi-Apochromatic, Long Working Distance objectives, for brightfield and darkfield, field flatness up to F.N. 25:

Eyepiece		10x (M-880)		
Field number		24 (mm)		
Objective	N.A.	W.D. (mm)	Total magnification	Field of view (mm)
5x	0.15	13.50	50x	4.8
10x	0.30	9.00	100x	2.40
20x	0.50	2.50	200x	1.20
50x	0.80	1.00	500x	0.48
100x	0.90	1.00	1000x	0.24



IM-5 Series - Accessories

Eyecups & Eyepieces

M-880	PL10x/24 eyepiece, high eyepoint, focusable, with rubber cup
M-881	PL10x/24 micrometric eyepiece, high eyepoint, focusable, rubber cup
M-882	WF15x/16 eyepiece, high eyepoint, focusable, with rubber cup

Objectives

IOS W-PLAN

M-782	IOS LWD W-PLAN objective 4x/0.10
M-773	IOS LWD W-PLAN objective 40x/0.60
M-786	IOS LWD W-PLAN objective 60x/0.70

IOS W-PLAN PH

M-782.1	IOS LWD W-PLAN PH objective 4x/0.13
M-783N	IOS LWD W-PLAN PH objective 10x/0.25
M-784N	IOS LWD W-PLAN PH objective 20x/0.40
M-785	IOS LWD W-PLAN PH objective 40x/0.65

IOS U-PLAN F

M-800	IOS LWD U-PLAN F objective 4x/0.13
M-801	IOS LWD U-PLAN F objective 10x/0.30
M-802	IOS LWD U-PLAN F objective 20x/0.45
M-803	IOS LWD U-PLAN F objective 40x/0.65
M-804	IOS LWD U-PLAN F objective 60x/0.75

IOS U-PLAN F PH

M-1177	IOS LWD U-PLAN F PH objective 20x/0.45
M-1178	IOS LWD U-PLAN F PH objective 40x/0.65

IOS U-PLAN MET (Brightfield)

M-1100	IOS LWD U-PLAN MET objective 5x/0.15
M-1101	IOS LWD U-PLAN MET objective 10x/0.30
M-1102	IOS LWD U-PLAN MET objective 20x/0.45
M-1103	IOS LWD U-PLAN MET objective 50x/0.55
M-1104	IOS LWD U-PLAN MET objective 100x/0.80 (dry)

IOS U-PLAN MET (Brightfield & Darkfield)

M-1094	IOS LWD U-PLAN MET BD objective 5x/0.15
M-1095	IOS LWD U-PLAN MET BD objective 10x/0.30
M-1096	IOS LWD U-PLAN MET BD objective 20x/0.45
M-1097	IOS LWD U-PLAN MET BD objective 50x/0.55
M-1098	IOS LWD U-PLAN MET BD objective 100x/0.80 (dry)

IOS U-PLAN F MET (Brightfield)

M-1171	IOS LWD U-PLAN F MET objective 5x/0.15
M-1172	IOS LWD U-PLAN F MET objective 10x/0.30
M-1173	IOS LWD U-PLAN F MET objective 20x/0.50
M-1174	IOS LWD U-PLAN F MET objective 50x/0.80
M-1175	IOS LWD U-PLAN F MET objective 100x/0.90 (dry)

IOS U-PLAN F MET (Brightfield & Darkfield)

M-1180	IOS LWD U-PLAN F MET BD objective 5x/0.15
M-1181	IOS LWD U-PLAN F MET BD objective 10x/0.30
M-1182	IOS LWD U-PLAN F MET BD objective 20x/0.50
M-1183	IOS LWD U-PLAN F MET BD objective 50x/0.80
M-1184	IOS LWD U-PLAN F MET BD objective 100x/0.90 (dry)

IOS LWD U-PLAN RPC

M-861	IOS LWD U-PLAN RPC objective 4x/0.13
M-862	IOS LWD U-PLAN RPC objective 10x/0.25
M-863	IOS LWD U-PLAN RPC objective 20x/0.40
M-864	IOS LWD U-PLAN RPC objective 40x/0.65

Condensers & Filters

M-550	Interferential green filter IF550 (except for IM-5MET)
M-677ND	Neutral density filter, 25% transmission (only for IM-5MET)
M-678ND	Neutral density filter, 50% transmission (only for IM-5MET)

Camera Adapters

M-113.1	Ring adapter, 30mm (for monocular and binocular microscopes)
M-115	0.35x C-Mount projection lens
M-114	0.5x C-Mount projection lens
M-118	0.75x C-Mount projection lens
M-173	C-Mount projection lens for APS-C/full frame reflex cameras (trino)
M-620	0.35x focusable C-Mount adapter (biological microscopes)
M-620.1	0.5x focusable C-Mount adapter (biological microscopes)
M-620.2	0.65x focusable C-Mount adapter (biological microscopes)
M-620.3	1x focusable C-Mount adapter (biological & stereomicroscopes)
M-699	Universal adapter for C-Mount projection lens (trino)

Miscellaneous

15104	Cleaning kit
CL-36	Halogen bulb 12V/100W (only for IM-5MET)
DC-005	TNT dust cover, extra large, 820(l)x550(h) mm
M-005	Micrometric slide, 26x76mm, with 2 scales (1mm/100 & 10mm/100)
M-641	Adapter for micromanipulator plate (only for IM-5)
M-793.1	Holder for Petri 38mm diameter (M-793.2 needed) (except for IM-5MET)
M-793.2	Holder for Terasaki and Petri 65mm diameter (except for IM-5MET)
M-793.3	Holder for slides and Petri 54mm diameter (except for IM-5MET)
M-793.4	Holder for 2+2 slides (except for IM-5MET)
M-793.5	Holder for metallurgical samples (only for IM-5MET)
M-793.6	Holder for Utermohl-Chamber (M-793.3 needed) (except for IM-5MET)
M-793.7	Load bearing side extension (except for IM-5MET)
M-860	Slider with rotating 10x-20x-40x OPTIKA Modulation Contrast slit
M-860.1	Slider with rotating 4x OPTIKA Modulation Contrast slit
M-870	DIC slider with Nomarski prism for reflected light (only for IM-5MET)
VP-IM5	IQ/OQ/PQ manual for IM-5 series
AB-030	Antibacterial surface treatment, only for newly purchased microscope



How to connect the cameras to our microscopes.

Please refer to the Adapter reference list on Digital section.

15104 - Cleaning kit

It cleans glass quickly and effectively, without leaving residue or odor. Ideal for precision lens or prism cleaning.



v 6.7 - OPTIKA reserves the right to make corrections, modifications, enhancements, improvements and other changes to its products at any time without notice.

Headquarters and Manufacturing Facilities

OPTIKA® S.r.l. Via Rigla, 30 - 24010 Ponteranica (BG) - ITALY - Tel.: +39 035.571.392 - info@optikamicroscopes.com

Optika Sales branches

OPTIKA® Spain spain@optikamicroscopes.com
 OPTIKA® China china@optikamicroscopes.com
 OPTIKA® India india@optikamicroscopes.com

OPTIKA® USA usa@optikamicroscopes.com
 OPTIKA® Central America camerica@optikamicroscopes.com

IM-7



Inverted Research Microscope

② IM-7 - Inverted Research Microscope

IM-7 represents the best of what Optika dedicates to the world of research.

This model was created to meet all the needs related to research in life science and designed to be complemented by a series of packages dedicated to more advanced individual applications.

For all intents and purposes, IM-7 is to be considered as an inverted imaging platform, due to its high expandability and state-of-the-art quality.



IM-7 - Inverted Research Microscope

Top-level of optical equipment among our product range provides a sharp and clear view in any situation, while top-level mechanical design offers sturdiness and long lifetime.



IM-7 - Inverted Research Microscope

IM-7

BRIGHTFIELD

Transmitted brightfield illumination is one of the most commonly used observation method in optical microscopy, and is ideal for fixed, stained specimens or other types of samples having high natural absorption of visible light.

IM-7 is fitted with high-efficiency LED brightfield illuminator, for the best outcome when using this technique.

Capsella middle embryo - Brightfield

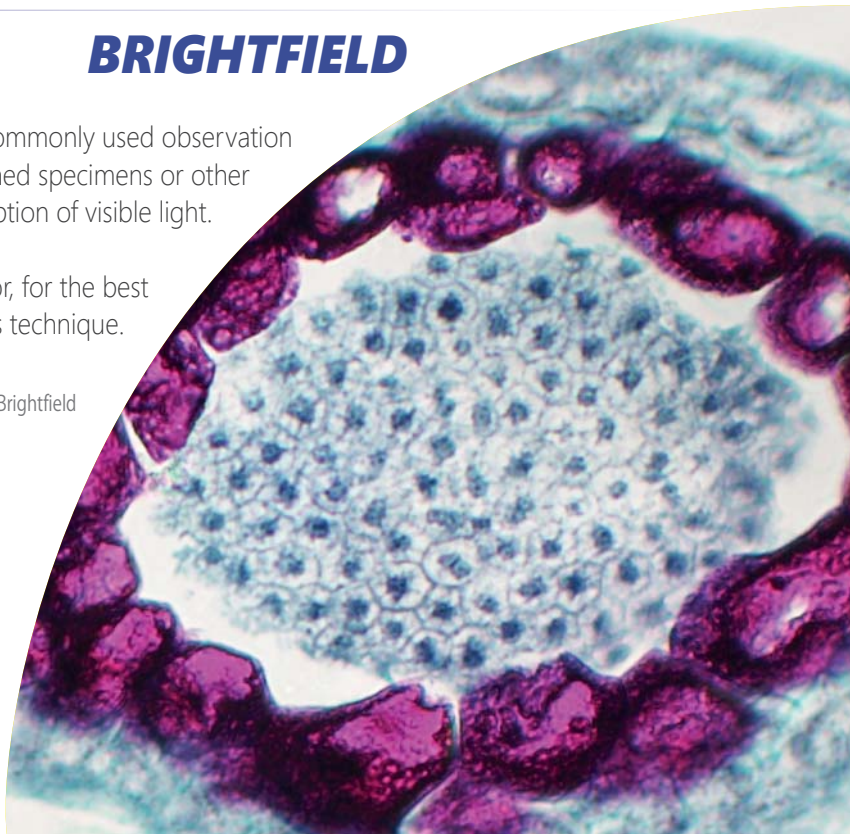

FLUORESCENCE

The fluorescence microscopy is the most demanding technique in biology and biomedical sciences, as well as in materials science.

This method is capable to study organic and inorganic samples thanks to primary fluorescence (auto-fluorescence) or secondary (staining and labelling with fluorochromes)

IM-7 is tailored for applications in research, clinical and pharmaceutical diagnostic field.
Fluorescence illuminators available as mercury lamp.

Cotton fibers - UV Fluorescence



Multiple Observation Methods

DIC

Differential Interference Contrast (DIC) is a microscopy technique that introduces contrast to images of specimens which have little or no contrast when observed using brightfield microscopy. The images produced using DIC have a pseudo 3D-effect, making the technique ideal for many applications.

DIC produces high resolution images with good contrast. It is best for observing unstained samples.

Sphagnum pores g - DIC

PHASE CONTRAST

Phase-contrast microscopy is a particular technique applied in transparent, non-stainable, samples like culture of living cells, microorganisms, lithographic patterns, latex dispersions, fibers, asbestos and subcellular particles.

It reveals many cellular structures that are not visible with a simple brightfield microscope.

Diatoms - Phase contrast

② IM-7 - Features



Revolving nosepiece for DIC and Fluorescence filter turret

The six-position nosepiece has a slot (in each of the six positions) for inserting DIC prisms.

The filter turret can hold up to six fluorescence filterblocks. It is easily extractable, in order to facilitate the operation of inserting or replacing the filterblocks.

Mechanical stage and universal condenser

The wide 3-layer mechanical stage comes with several interchangeable plates for the use of Petri dishes, flasks and slides. The movement of the stage is controlled by a long tilting handle equipped with a pair of knobs for X/Y axes.

The universal condenser is a 6-position type, designed for brightfield, phase contrast and DIC.



Illuminator arm

The arm of the transmitted illuminator is backward tilting up to 30 degrees and it allows to use flasks and big bottles.



Main photo tube and Bertrand lens

The main photo tube located on the binocular head is easily controllable by using its control knob. 3 positions selectable: 100/0, 50/50, 0/100.

For phase contrast centering operations a Bertrand lens is available and it can be easily inserted by means of a dedicated knob.

Fluorescence equipment

A complete package of accessory dedicated to Fluorescence technique is available as option.



Fluorescence filterblocks

In addition to the four standard fluorescence B-G-V-UV filterblocks, many others are available upon request to satisfy every kind of need.

② IM-7 - Features / Controls



IM-7 - Features / Controls

- 1 - Main photo tube, on binocular head
- 2 - Handle, for transportation
- 3 - Handle, for transportation
- 4 - Transmitted illuminator switch
- 5 - Fluorescence illuminator switch
- 6 - Magnification changer, 1x-1.5x
- 7 - Right side photo tube
- 8 - Universal condenser, for brightfield, PH and DIC
- 9 - Binocular head, with standard WF10x/22mm eyepieces or WF10x/25mm (optional)
- 10 - Slots for field diaphragm, aperture diaphragm, ND filters

- 11 - Input port for fluorescence illuminator
- 12 - Left side photo tube
- 13 - Side photo tubes control (100/0 ; 20/80 ; 0/100)
- 14 - Main photo tube control (100/0 ; 50/50 ; 0/100)
- 15 - Bertrand lens insertion control
- 16 - Main switch
- 17 - Slot for analyzer
- 18 - Focusing knobs
- 19 - 3-layer mechanical stage
- 20 - Transmitted illuminator brightness control



IM-7 - Standard Specifications

Part	Description
Optical system:	Infinity corrected.
Head:	Type: Trinocular (Siedentopf); Inclination 45°; Interpupillary distance 47-78 mm; Tube inner diameter 30 mm; Built-in Bertrand lens.
Photo tubes:	Trino Port/Binocular: 100/0 ; 50/50 ; 0/100; Left Side Port/Binocular: 100/0 ; 0/100.; Right Side Port/Binocular: 100/0; 20/80.
Eyepieces:	PLAN WF10x/25 mm, high eyepoint and with built-in rubber cups; focusable .
Nosepiece:	Sextuple ball bearings revolving nosepiece, reversed; DIC slots fo all positions.
Objectives:	Infinity corrected; 60 mm parfocal distance; All with anti-fungus treatment; Selectable according to customer's preferences (see objective table).
Magnification changer:	1x, 1.5x
Specimen stage:	340x230 mm, three-layers mechanical stage; 130x85 mm moving range; Moving mechanism: Rack and pinion (flexible knob); Holder for Petri dish, 160x110 mm; Holder for Terasaki plate (96 well); Holder for 1 slide. Anti-scratch painting.
Focusing:	Coaxial coarse and fine focusing mechanism with limit stop to prevent the contact between objective and specimen; Adjustable tension of coarse focusing knob; 10 mm coarse total travel; Coarse travel per single rotation: 2 mm; Fine travel per single rotation: 0.2 mm; Fine graduations: 100; Fine resolution: 2 µm.
Condenser:	Koehler type, 6-position, focusable, centrable; N.A. 0.55; Iris diaphragm; Phase contrast positions: 10x PH, 20x PH, 40x PH (rings included); DIC positions: DIC1 (10x), DIC2 (20x, 40x, 60x) (prisms not included); 26 mm working distance.
Transmitted illumination (Full Koehler):	X-LED ¹⁰ ; 10W LED, high efficiency, 6000K; Brightness control; 65.000-hour lifetime.
Incident illumination:	Upgradable to Incident Fluorescence illumination through the purchase of the components indicated in the fluoscence package table.
Differential Interference Contrast (DIC)	Upgradable to DIC through the purchase of the components indicated in the DIC package table.

IM-7 - Objectives/Application Packages

IM-7 is freely configurable in terms of objectives, by choosing among:

Included Optional

Infinity-corrected Semi-Apochromatic, Long Working Distance objectives, field flatness up to F.N. 25. Objectives 20x, 40x, and 60x feature a correction collar in order to compensate for various thicknesses of cover glasses or different containers.

M-1320	IOS LWD U-PLAN F (SEMI-APO) PH 4x/0.13, W.D. 16.5 mm, Cover glass -	<input type="checkbox"/>
M-1321	IOS LWD U-PLAN F (SEMI-APO) PH 10x/0.3, W.D. 7.4 mm, Cover glass 1.2 mm	<input type="checkbox"/>
M-1322	IOS LWD U-PLAN F (SEMI-APO) PH 20x/0.45, W.D. 7.5 - 8.8 mm, Cover glass 0 - 2 mm	<input type="checkbox"/>
M-1323	IOS LWD U-PLAN F (SEMI-APO) PH 40x/0.60, W.D. 3.0 - 4.4 mm, Cover glass 0 - 2 mm	<input type="checkbox"/>
M-1324	IOS LWD U-PLAN F (SEMI-APO) PH 60x/0.70, W.D. 1.8 - 2.6 mm, Cover glass 0.1 - 1.3 mm	<input type="checkbox"/>

HBO Fluorescence package:

Included Optional

M-1330	EPI Fluorescence internal attachment	<input type="checkbox"/>
M-151.1	OSRAM 100W HBO high pressure mercury bulb	<input type="checkbox"/>
M-1332	HBO Lamp house	<input type="checkbox"/>
PS-HBO	Optika 100W HBO power supply	<input type="checkbox"/>
M-1334	6-position fluorescence filterbox turret	<input type="checkbox"/>
M-1335	UV protector orange shield	<input type="checkbox"/>
M-1336	B filterblock, filters included	<input type="checkbox"/>
M-1337	G filterblock, filters included	<input type="checkbox"/>
M-1338	V filterblock, filters included	<input type="checkbox"/>
M-1339	UV filterblock, filters included	<input type="checkbox"/>
M-1340	Aperture diaphragm slider	<input type="checkbox"/>
M-1341	Field diaphragm slider	<input type="checkbox"/>
M-1342	Slider with neutral density filter for HBO illumination	<input type="checkbox"/>
M-1343	Empty fluorescence filterblock	<input type="checkbox"/>

Name	Excitation filter (nm)	Dichroic cut-off mirror (nm)	Emission filter (nm)
B (Blue)	460 - 490	500	510LP
G (Green)	510 - 550	570	590LP
V (Violet)	400 - 410	455	455LP
UV (Ultraviolet)	330 - 385	400	420LP

DIC - Differential Interference Contrast package:

Included Optional

M-1350	DIC Prism for 10x	<input type="checkbox"/>
M-1351	DIC Prism for 20x	<input type="checkbox"/>
M-1352	DIC Prism for 40x	<input type="checkbox"/>
M-1353	DIC prism for 60x	<input type="checkbox"/>
M-1354	DIC 1 prism 10x for condenser	<input type="checkbox"/>
M-1355	DIC 2 prism 20x-40x-60x for condenser	<input type="checkbox"/>
M-1356	Slider with rotating analyzer	<input type="checkbox"/>

IM-7 - Accessories

Eyecups & Eyepieces

- M-1360 PL10x/25, high eyepoint, focusable, rubber cup
 M-1361 PL10x/25, micrometric eyepiece, high eyepoint, focusable, rubber cup

Objectives

- M-1320 IOS U-PLAN F (SEMI-APO) PH 4x/0.13, W.D. 16.5 mm, Cover glass -
 M-1321 IOS U-PLAN F (SEMI-APO) PH 10x/0.3, W.D. 7.4 mm, Cover glass 1.2 mm
 M-1322 IOS U-PLAN F (SEMI-APO) PH 20x/0.45, W.D. 7.5 - 8.8 mm, Cover glass 0 - 2 mm
 M-1323 IOS U-PLAN F (SEMI-APO) PH 40x/0.60, W.D. 3.0 - 4.4 mm, Cover glass 0 - 2 mm
 M-1324 IOS U-PLAN F (SEMI-APO) PH 60x/0.70, W.D. 1.8 - 2.6 mm, Cover glass 0.1 - 1.3 mm

Fluorescence package

- M-1330 EPI Fluorescence internal attachment
 M-151.1 OSRAM 100W HBO high pressure mercury bulb
 M-1332 HBO lamp house
 PS-HBO 100W HBO power supply)
 M-1334 6-position fluorescence filterbox turret
 M-1335 UV protector orange shield
 M-1336 B filterblock, filters included
 M-1337 G filterblock, filters included
 M-1338 V filterblock, filters included
 M-1339 UV filterblock, filters included
 M-1340 Aperture diaphragm slider
 M-1341 Field diaphragm slider

DIC package

- M-1350 DIC Prism for 10x
 M-1351 DIC Prism for 20x
 M-1352 DIC Prism for 40x
 M-1353 DIC Prism for 60x
 M-1354 DIC 1 prism 10x for condenser
 M-1355 DIC 2 prism 20x-40x-60x for condenser
 M-1356 Slider with rotating analyzer

Camera Adapters

- M-620 0.35x focusable C-Mount adapter (for main photo tube only)
 M-620.1 0.5x focusable C-Mount adapter (for main photo tube only)
 M-620.2 0.65x focusable C-Mount adapter (for main photo tube only)
 M-620.3 1x focusable C-Mount adapter (for main photo tube only)
 M-1365 0.5x focusable C-Mount adapter (for left/right side photo tube only)
 M-1366 1x focusable C-Mount adapter (for left/right side photo tube only)

Miscellaneous

- M-1370 Color temperature filter, 38mm
 M-1371 Green filter, 38mm
 M-1372 Yellow filter, 38mm
 M-1373 Frosted filter, 38mm
 15104 Cleaning kit
 DC-005 TNT dust cover, extra large, 820(l)x550(h) mm
 M-005 Micrometric slide, 26x76mm, with 2 scales (1mm/100 & 10mm/100)
 VP-IM7 IQ/OQ/PQ manual for IM-7
 AB-040 Antibacterial surface treatment, only for newly purchased microscope

15104 - Cleaning kit

It cleans glass quickly and effectively, without leaving residue or odor. Ideal for precision lens or prism cleaning.



How to connect the cameras to our microscopes.

Please refer to the Adapter reference list on Digital section.

v 6.7 - OPTIKA reserves the right to make corrections, modifications, enhancements, improvements and other changes to its products at any time without notice.

Headquarters and Manufacturing Facilities

OPTIKA® S.r.l. Via Rigla, 30 - 24010 Ponteranica (BG) - ITALY - Tel.: +39 035.571.392 - info@optikamicroscopes.com

Optika Sales branches

OPTIKA® Spain spain@optikamicroscopes.com
 OPTIKA® China china@optikamicroscopes.com
 OPTIKA® India india@optikamicroscopes.com

OPTIKA® USA usa@optikamicroscopes.com
 OPTIKA® Central America camerica@optikamicroscopes.com

POL Series



Routine & Research Lab Polarizing Microscopes

2 Polarized Light Microscopy

Polarized light microscopy is an optical microscopy technique involving polarized light. Simple techniques include illumination of the sample with polarized light. Directly transmitted or incident light can, optionally, be blocked with a polariser orientated at 90 degrees to the illumination.

These illumination techniques are most commonly used on birefringent samples where the polarized light interacts strongly with the sample and so generating contrast with the background. Polarized light microscopy is used extensively in optical mineralogy.

As polarised light passes through a birefringent sample, the phase difference between the fast and slow directions varies with the thickness, and wavelength of light used. The optical path difference (o.p.d.) is defined as

$$\text{o.p.d.} = \Delta n \times t$$

where t is the thickness of the sample.

This then leads to a phase difference between the light passing in the two vibration directions of

$$\delta = 2\pi (\Delta n \times t / \lambda)$$

For example, if the optical path difference is $\lambda / 2$, then the phase difference will be π , and so the polarisation will be perpendicular to the original, resulting in all of the light passing through the analyser for crossed polars.

If the optical path difference is $n \times \lambda$, then the phase difference will be $2n \times \pi$, and so the polarisation will be parallel to the original. This means that no light will be able to pass through the analyser which it is now perpendicular to.

The Michel-Levy Chart arises when polarised white light is passed through a birefringent sample. If the sample is of uniform thickness, then only one specific wavelength will meet the above condition described above, and be perpendicular to the direction of the analyser. This means that instead of polychromatic light being viewed at the analyser, one specific wavelength will have been removed. This information can be used in a number of ways:

- If the birefringence is known, then the thickness, t , of the sample can be determined
- If the thickness is known, then the birefringence of the sample can be determined

As the order of the optical path difference increases, then it is more likely that more wavelengths of light will be removed from the spectrum. This results in the appearance of the colour being "washed out", and it becomes more difficult to determine the properties of the sample. This, however, only occurs when the sample is relatively thick when compared to the wavelength of light.

Icons



Field number



Incident light



Transmitted light



X-LED illuminator



Multi-Plug low voltage power supply



Infinity corrected optics



Polarized light



W-PLAN Objectives
(22mm field of view)



U-PLAN Objectives
(25mm field of view)

B-383POL - Polarizing Microscope

Upright microscope for brightfield and polarizing light observations with strain-free IOS N-PLAN POL objectives. Complete of polarizer and analyzer filters, Bertrand lens for conoscopic observation, compensator plates and high-precision rotatable stages. It comes with the exclusive **X-LED³** illumination system to deliver bright and clear images, along with all the accessories to perform accurate polarization analysis in biology and materials science.

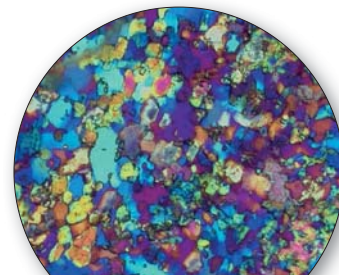

4x with First Order plate

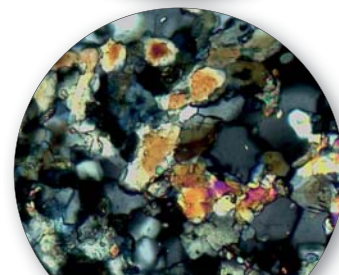

10x

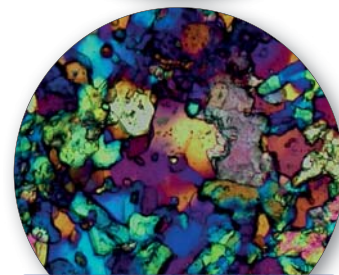

10x with First Order plate

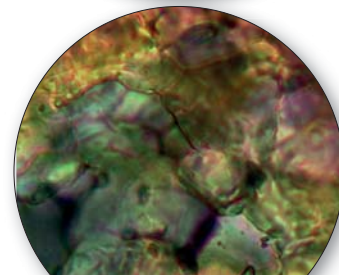

60x

Part	Description
Observation mode:	Brightfield, transmitted polarized light and conoscopy.
Bertrand lens and polarizing attachment:	Swing-out type with centering mechanism for observation in conoscopy/orthoscopy. Rotatable analyzer from 0° to 90° with graduated scale. Tint plates: 1° order red (λ); $\lambda/4$; Quartz wedge.
Head:	Trinocular (fixed 50/50), 30° inclined, 360° rotating.
Interpupillary distance:	Adjustable between 48 and 75 mm.
Dioptric adjustment:	On the left eyepiece tube.
Eyepieces:	WF10x/20 mm, high eye-point and secured by screw. One with crosshair.
Nosepiece:	Quadruple revolving nosepiece, rotation on ball bearings. Centering system for each objective.

Part	Description
Objectives (strain-free):	IOS N-PLAN POL 4x/0.10 IOS N-PLAN POL 10x/0.25 IOS N-PLAN POL 40x/0.65 IOS N-PLAN POL 60x/0.80 All with anti-fungus treatment.
Specimen stage:	Rotatable stage with locking mechanism. Vernier scale with accuracy 0.1 mm. Diameter 160 mm. Specimen slide clamps.
Focusing:	Coaxial coarse (adjustable tension) and fine focusing mechanism with limit stop to prevent the contact between objective and specimen.
Condenser:	Abbe N.A. 1.25, with objective-coded iris diaphragm, focusable and centerable. With rotating polarizing filter.
Transmitted illumination (Fixed Koehler type):	X-LED ³ with white 3.6 W LED (6.300 K) with brightness control. Multi-plug 100-240Vac/6Vdc external power supply.

2 B-510POL - Polarizing Microscope

Advanced routine laboratory microscope for transmitted light in brightfield and polarized light observations with strain-free IOS W-PLAN POL objectives. Complete of polarizer and analyzer filters, Bertrand lens for conoscopic observation, compensator plates and high-precision rotatable stages. It comes with the exclusive **X-LED³** illumination system to deliver bright and clear images, along with all the accessories to perform accurate polarization analysis in biology and materials science.

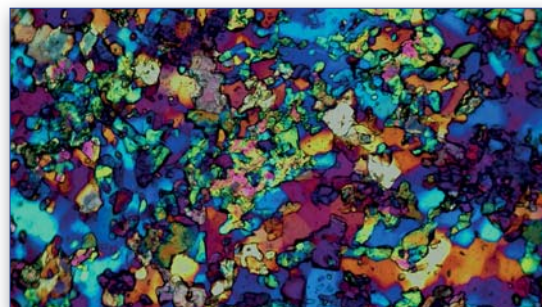

Part	Description
Observation mode:	Brightfield, transmitted polarized light and conoscopy.
Bertrand lens and polarizing attachment:	Swing-out type with centering mechanism for observation in conoscopy/orthoscopy. Rotatable analyzer from 0° to 90° with graduated scale. Tint plates: 1° order red (λ); $\lambda/4$; Quartz wedge.
Head:	Trinocular (fixed 50/50), 30° inclined, 360° rotating.
Interpupillary distance:	Adjustable between 50 and 75 mm.
Dioptric adjustment:	On the left eyepiece tube.
Eyepieces:	WF10x/22 mm, high eye-point and with rubber cups. One with crosshair.
Nosepiece:	Quadruple revolving nosepiece, rotation on ball bearings. Centering system for each objective.

Part	Description
Objectives (strain-free):	IOS W-PLAN POL 4x/0.10 IOS W-PLAN POL 10x/0.25 IOS W-PLAN POL 20x/0.45 IOS W-PLAN POL 40x/0.65 All with anti-fungus treatment.
Specimen stage:	Rotatable stage with locking mechanism and centering knobs. Vernier scale with accuracy 0.1 mm. Diameter 145 mm. Specimen slide clamps.
Focusing:	Coaxial coarse (adjustable tension) and fine focusing mechanism with limit stop to prevent the contact between objective and specimen.
Condenser:	Swing-out N.A. 0.2/0.9, with iris diaphragm, focusable and centerable. With rotating polarizing filter.
Transmitted illumination (Full Koehler type):	X-LED ³ with white 3.6 W LED (6.300 K) with brightness control. Multi-plug 100-240Vac/6Vdc external power supply.

B-510POL-I - Polarizing Microscope

Advanced routine laboratory microscope for brightfield and polarized light observations in transmitted and incident light with strain-free IOS LWD W-PLAN POL objectives. Complete of polarizer and analyzer filters, Bertrand lens for conoscopic observation, compensator plates and high-precision rotatable stages. It comes with the exclusive **X-LED³** illumination system to deliver bright and clear images, along with all the accessories to perform accurate polarization analysis in biology and materials science.

- 22
-
-
-
-
-
-
-

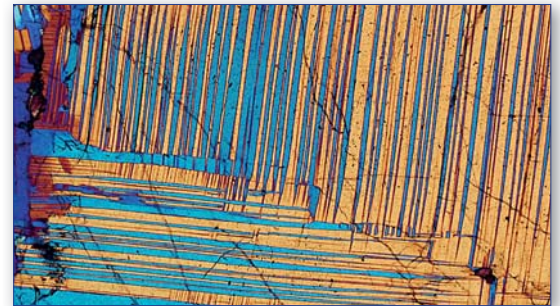

Incident/transmitted light Objectives included

Description
IOS LWD W-PLAN POL 5x/0.12, W.D. 15.5 mm
IOS LWD W-PLAN POL 10x/0.25, W.D. 10.0 mm
IOS LWD W-PLAN POL 20x/0.40, W.D. 5.8 mm
IOS LWD W-PLAN POL 50x/0.75, W.D. 0.32 mm

Part	Description
Observation mode:	Brightfield, transmitted/incident polarized light and conoscopy.
Epi-illumination and filters:	X-LED ³ with white 8 W LED (6.300 K) with brightness control. With polarizer and rotating analyzer for incident illumination, aperture and field diaphragm. With additional filter holder.
Bertrand lens and polarizing attachment:	Swing-out type with centering mechanism for observation in conoscopy/orthoscopy. Rotatable analyzer from 0° to 90° with graduated scale. Tint plates: 1° order red (λ); $\lambda/4$; Quartz wedge.
Head:	Trinocular (fixed 50/50), 30° inclined, 360° rotating.
Interpupillary distance:	Adjustable between 50 and 75 mm.
Dioptric adjustment:	On the left eyepiece tube.
Eyepieces:	WF10x/22 mm, high eye-point and with rubber cups. One with crosshair.
Nosepiece:	Quadruple revolving nosepiece, rotation on ball bearings. Centering system for each objective.

Part	Description
Objectives (strain-free):	IOS LWD W-PLAN POL 5x/0.12 IOS LWD W-PLAN POL 10x/0.25 IOS LWD W-PLAN POL 20x/0.40 IOS LWD W-PLAN POL 50x/0.75 All with anti-fungus treatment.
Specimen stage:	Rotatable stage with locking mechanism and centering knobs. Vernier scale with accuracy 0.1 mm. Diameter 145 mm. Specimen slide clamps.
Focusing:	Coaxial coarse (adjustable tension) and fine focusing mechanism with limit stop to prevent the contact between objective and specimen.
Condenser:	Swing-out N.A. 0.2/0.9, with iris diaphragm, focusable and centerable. With rotating polarizing filter.
Transmitted illumination (Full Koehler type):	X-LED ³ with white 3.6 W LED (6.300 K) with brightness control. Multi-plug 100-240Vac/6Vdc external power supply.

2 B-1000POL - Polarizing Microscope

The modular OPTIKA B-1000 is available with transmitted polarized light, helping you working in a comfortable way during extended periods of use and performing reliable, accurate and rapid diagnosis benefiting from modularity, which gives the chance to create customized configurations tailored on customer needs. Versatile, robust, durable and sturdy, B-1000 offers premium quality optics, the state-of-the-art, exclusive **X-LED⁸** (8 W) illumination system, designed by OPTIKA and the Koehler diaphragm.

B-1000 gives multiple options as manual or motorized configuration.



22



24



Dedicated version for transmitted
(**X-LED⁸**, 8 W)
illumination and polarization analysis.

B-1000POL - Configuration Chart

Build the microscope that suites your needs by choosing among the components

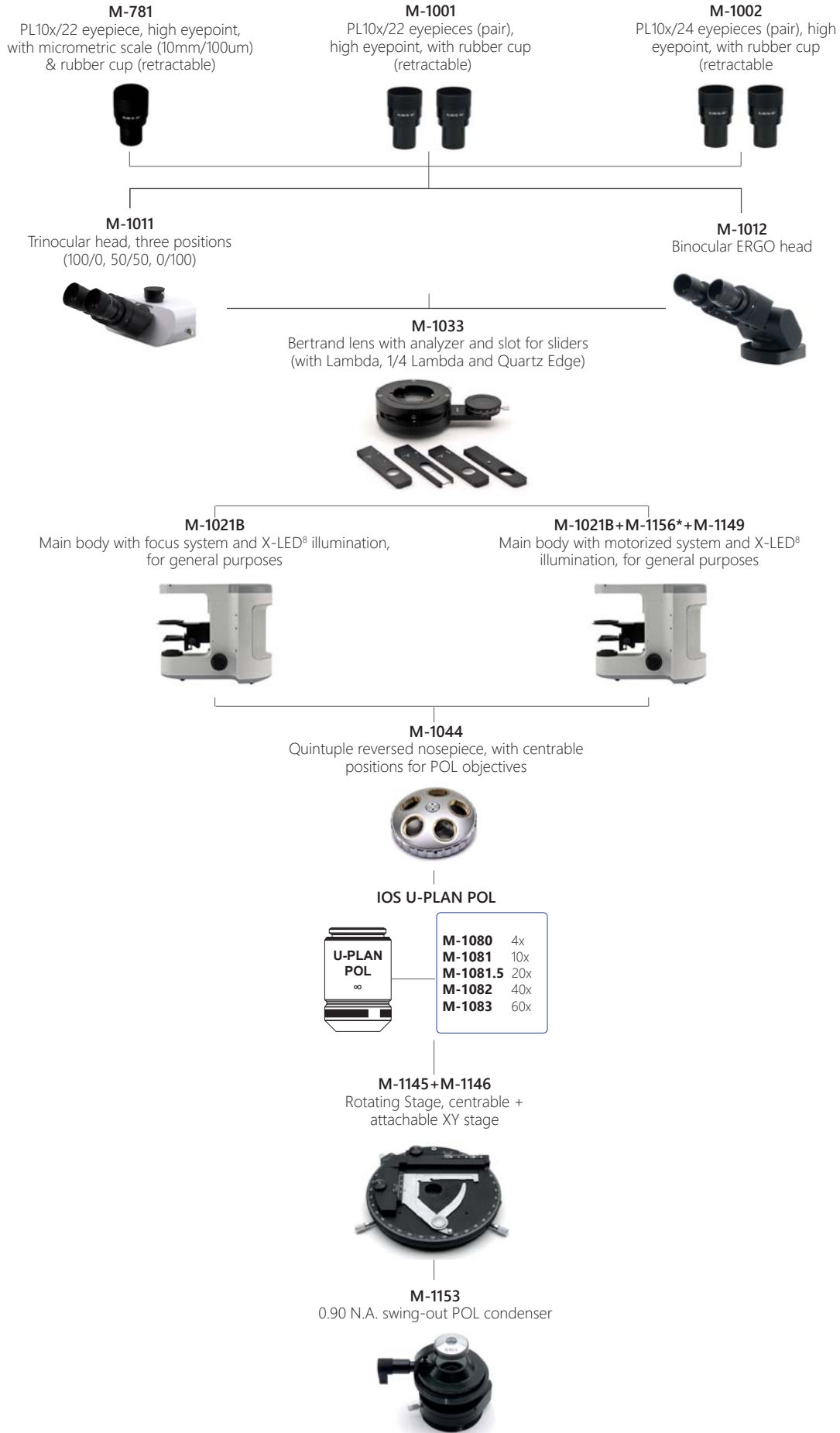

* Code M-1156 must be added only **once** for any motorized configuration

② B-1000POL-I - Polarizing Microscope

The modular OPTIKA B-1000 is available with transmitted and incident polarized light, helping you working in a comfortable way during extended periods of use and performing reliable, accurate and rapid diagnosis benefiting from modularity, which gives the chance to create customized configurations tailored on customer needs. Versatile, robust, durable and sturdy, B-1000 offers premium quality optics, the state-of-the-art, exclusive **X-LED[®]** (8 W) illumination system, designed by OPTIKA and the Koehler diaphragm.

B-1000 gives multiple options as manual or motorized configuration.



Dedicated version for transmitted and incident illumination (**X-LED[®]**, 8 W)



B-1000POL-I - Configuration Chart

Build the microscope that suites your needs by choosing among the components

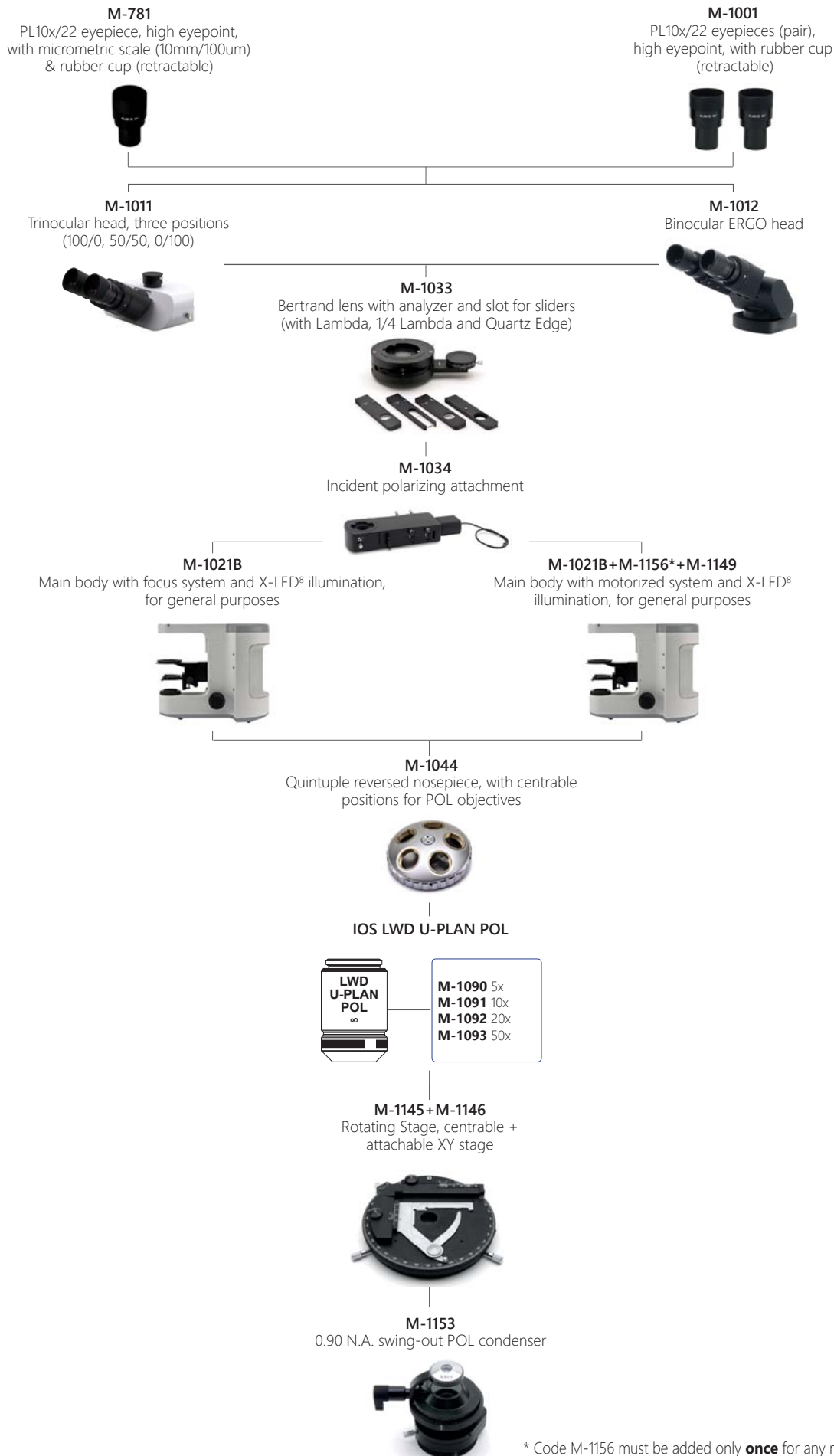

* Code M-1156 must be added only **once** for any motorized configuration

v 6.7 - OPTIKA reserves the right to make corrections, modifications, enhancements, improvements and other changes to its products at any time without notice.

Headquarters and Manufacturing Facilities

OPTIKA® S.r.l. Via Rigla, 30 - 24010 Ponteranica (BG) - ITALY - Tel.: +39 035.571.392 - info@optikamicroscopes.com

Optika Sales branches

OPTIKA® Spain spain@optikamicroscopes.com

OPTIKA® China china@optikamicroscopes.com

OPTIKA® India india@optikamicroscopes.com

OPTIKA® USA usa@optikamicroscopes.com

OPTIKA® Central America camerica@optikamicroscopes.com

FLUO Series



Routine & Research Lab Fluorescence Microscopes

Epi Fluorescence microscopes

A fluorescence microscope is an optical microscope that uses fluorescence and phosphorescence instead of, or in addition to, reflection and absorption to study properties of organic or inorganic substances. The “fluorescence microscope” refers to any microscope that uses fluorescence to generate an image. The Epi Fluorescence microscope is equipped with a fluorescence illuminator which generates incident fluorescence light.

Principle

The specimen is illuminated with light of a specific wavelength (or wavelengths) which is absorbed by the fluorophores, causing them to emit light of longer wavelengths (i.e., of a different color than the absorbed light). The illumination light is separated from the much weaker emitted fluorescence through the use of a spectral emission filter. Typical components of a fluorescence microscope are a light source (HBO mercury-vapor lamps are common; more advanced forms are high-power LEDs), the excitation filter, the dichroic mirror, and the emission filter. The filters and the dichroic mirror are chosen to match the spectral excitation and emission characteristics of the fluorophore used to label the specimen. In this manner, the distribution of a single fluorophore (color) is imaged at a time. Multi-color images of several types of fluorophores must be composed by combining several single-color images.

Most fluorescence microscopes in use are epifluorescence microscopes, where excitation of the fluorophore and detection of the fluorescence are done through the same light path (through the objective). These microscopes are widely used in biology and are the basis for more advanced microscope designs.

Icons



Field number



Oil/Water 100x objective



Incident light



N-PLAN Objectives
(20mm field of view)



Transmitted light



X-LED illuminator



Multi-Plug low voltage power supply



W-PLAN Objectives
(22mm field of view)



IOS Infinity corrected optics



FL Fluorescence



PH Phase contrast



U-PLAN Objectives
(25mm field of view)

Fluorescence Microscopy

Epifluorescence microscopy

The majority of fluorescence microscopes, especially those used in the life sciences, are of the epifluorescence design. Light of the excitation wavelength illuminates the specimen through the objective lens. The fluorescence emitted by the specimen is focused to the detector by the same objective that is used for the excitation which for greater resolution will need objective lens with higher numerical aperture. Since most of the excitation light is transmitted through the specimen, only reflected excitatory light reaches the objective together with the emitted light and the epifluorescence method therefore gives a high signal-to-noise ratio. The dichroic beamsplitter acts as a wavelength specific filter, transmitting fluoresced light through to the eyepiece or detector, but reflecting any remaining excitation light back towards the source.

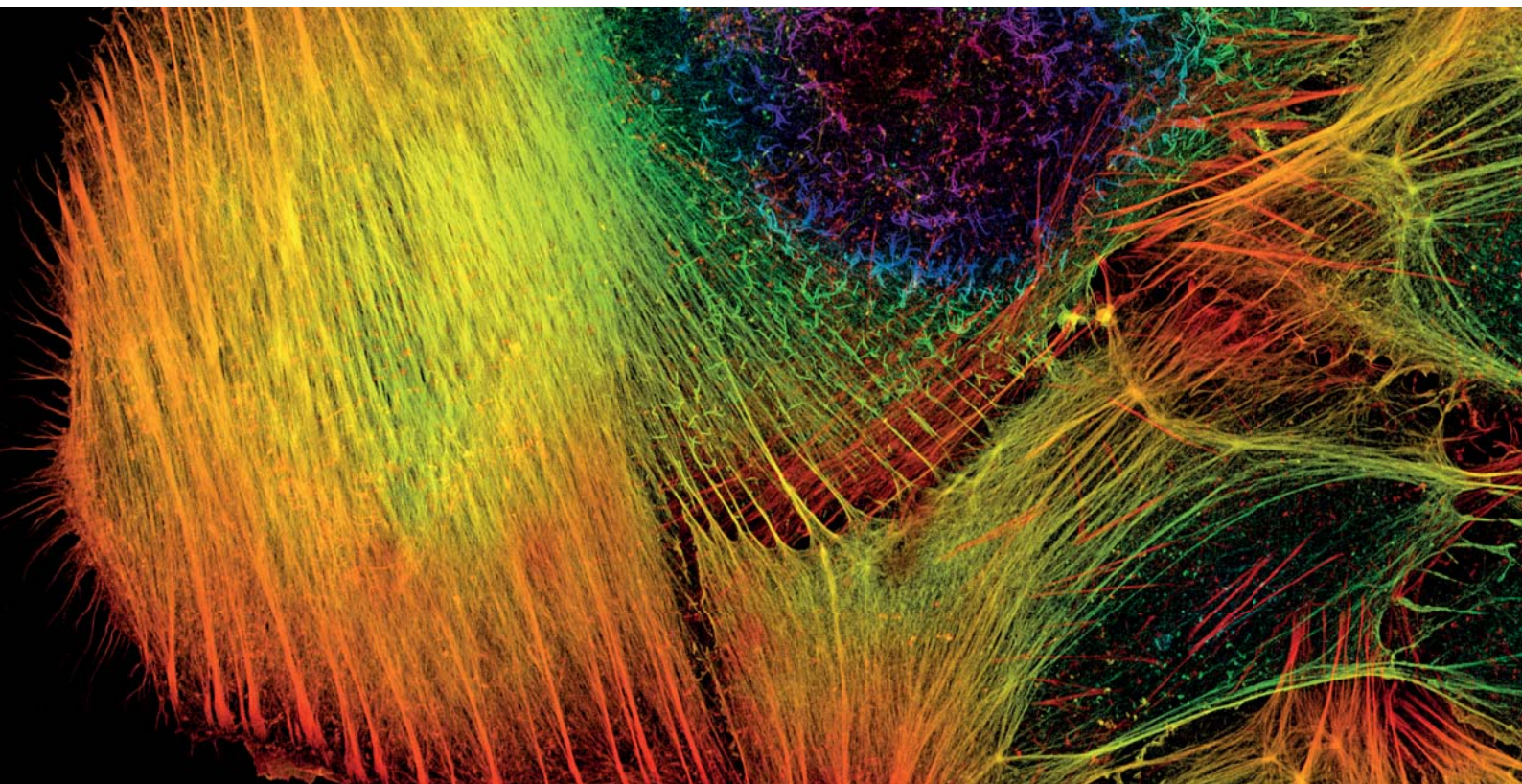
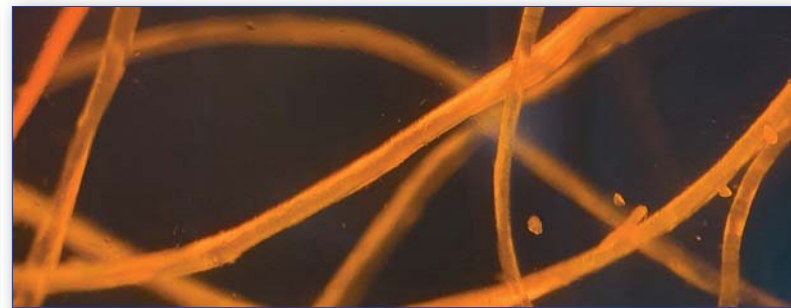
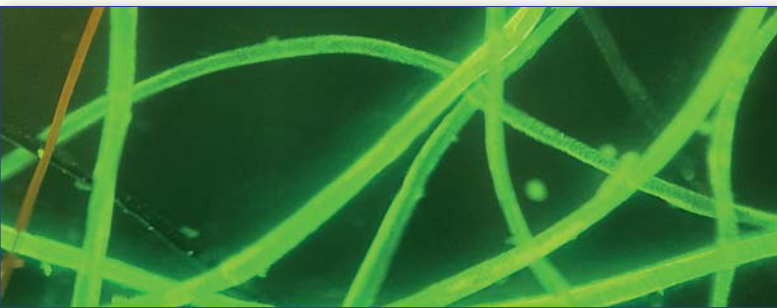

B-290LD - LED Fluorescence Microscopes

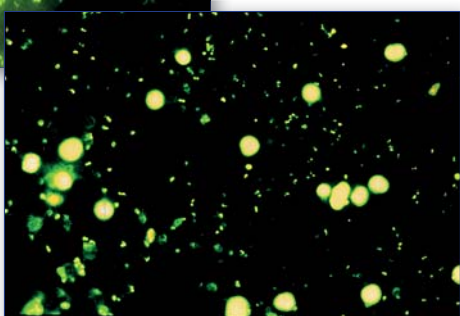
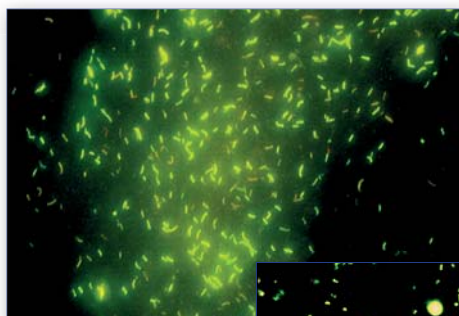

Fluorescence binocular and trinocular microscopes especially designed for tuberculosis and malaria analysis.

Observation mode: Brightfield.

Head: Binocular or trinocular, 360° rotating and 30° inclined. Interpupillary distance 48-75mm.

Dioptric adjustment: On the left eyepiece tube.

Eyepieces: WF10x/20 mm, high eye-point and secured by a screw.

Nosepiece: Quadruple revolving nosepiece, rotation on ball bearings.

Specimen stage: Double layer rackless mechanical sliding stage, 150x139 mm, 75x33 mm X-Y movement range. Vernier scale on the two axes, accuracy: 0.1 mm.

Focusing: Coaxial coarse and fine focusing mechanism with limit stop to prevent the contact between objective and specimen. Adjustable tension of coarse focusing knob.

Condenser: Abbe N.A. 1.25, with objective-coded iris diaphragm, focusable and centerable.

Brightfield Illumination (Fixed Koehler type): X-LED³ with white 3.6 W LED (6,300 K) and light intensity control.

Multi-plug 100-240Vac/6Vdc external power supply.

Fluorescence Illumination: Extra efficiency LED, with light intensity control. Peak wavelength: 465 nm, Power: 3.6W.

Epi Fluorescence Attachment: Slider with 3 positions (2 fluorescence, 1 brightfield), with 1 included filterset: Fluorescence B: EX 460-490, DM 505, EM 515LP: Acridine Yellow, Acridine Orange, Auramine, DiO, DTAF, FITC, GFP, YFP, etc.

Part number: B-292LD1.50

Equipped with binocular head and following objectives:

IOS N-PLAN 10x/0.25 (Cover/No Cover), with anti-fungus treatment
IOS N-PLAN 20x/0.40 (Cover/No Cover), with anti-fungus treatment
IOS N-PLAN 40x/0.65 (Cover/No Cover), with anti-fungus treatment
IOS W-PLAN MET 50x/0.75 (No Cover), with anti-fungus treatment.

Part number: B-293LD1.50

Trinocular version of B-292LD1.50.

Part number: B-292LD1

Equipped with binocular head and following objectives:

IOS N-PLAN 10x/0.25 (Cover/No Cover), with anti-fungus treatment
IOS N-PLAN 20x/0.40 (Cover/No Cover), with anti-fungus treatment
IOS N-PLAN 40x/0.65 (Cover/No Cover), with anti-fungus treatment
IOS W-PLAN 100x/0.80 (No Cover, Dry), with anti-fungus treatment.

Part number: B-293LD1

Trinocular version of B-292LD1.

Standard filterset

Name	Excitation filter (nm)	Dichroic mirror cut-off (nm)	Emission filter (nm)
B (Blue)	460 – 490	505	515LP

B-383FL - HBO Fluorescence Microscope

Laboratory upright microscope for brightfield and fluorescence observations with IOS N-PLAN objectives.

The HBO fluorescence illuminator provides an outstanding flexibility of use, standing the blue and green filter sets (supplied as standard) for Auramine, FITC, GFP and YFP (with blue filter set) plus Rhodamine, Texas Red and TRITC (with the green one), yet giving the possibility to combine any other specific filter sets for future upgrade. Transmitted light through the exclusive **X-LED³** to ensure great-looking, rich and high-quality specimen view.

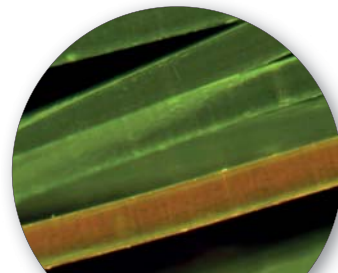

10x - Blue excitation

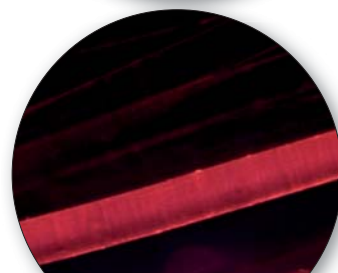

10x - Green excitation

Standard filterset

Name	Excitation filter (nm)	Dichroic mirror cut-off (nm)	Emission filter (nm)
B Blue	460 – 490	505	515LP
G Green	510 – 550	570	575LP



Part	Description
Observation mode:	Brightfield, HBO fluorescence.
Epi-illumination and filters:	HBO 100 W high pressure mercury lamp. 3-position filter holder; blue and green included.
Head:	Trinocular (fixed 50/50), 30° inclined, 360° rotating.
Interpupillary distance:	Adjustable between 48 and 75 mm.
Dioptric adjustment:	On the left eyepiece tube.
Eyepieces:	WF10x/20 mm, high eye-point and secured by screw.
Nosepiece:	Quintuple revolving nosepiece, rotation on ball bearings.
Objectives:	IOS N-PLAN 4x/0.10 IOS N-PLAN 10x/0.25 IOS N-PLAN 20x/0.40 IOS N-PLAN 40x/0.65 IOS N-PLAN 100x/1.25 (Oil/Water) All with anti-fungus treatment.

Part	Description
Specimen stage:	Double layer rackless mechanical stage, 233x147 mm, 78x54 mm X-Y range.
Focusing:	Coaxial coarse (adjustable tension) and fine focusing mechanism with limit stop to prevent the contact between objective and specimen.
Condenser:	Abbe N.A. 1.25, with objective-coded iris diaphragm, focusable and centerable.
Transmitted illumination (Fixed Koehler type):	X-LED ³ with white 3.6 W LED (6,300K) with brightness control. Multi-plug 100-240Vac/6Vdc external power supply.

B-383LD - LED Fluorescence Microscope

Entry-level laboratory upright microscope for brightfield and fluorescence observations with IOS N-PLAN objectives. The extremely powerful LED fluorescence illuminator is combined with blue excitation filter set for the visualization of the following fluorochromes: Acridine Yellow, Acridine Orange, Auramine, DiO, DTAF, FITC, GFP, YFP, etc. LED fluorescence ensures unparalleled convenience eliminating warm-up/cool-down times and all the inconveniences related lamp replacement and adjustment. Transmitted light through the exclusive **X-LED³** to ensure great-looking, rich and high-quality specimen view.



4x

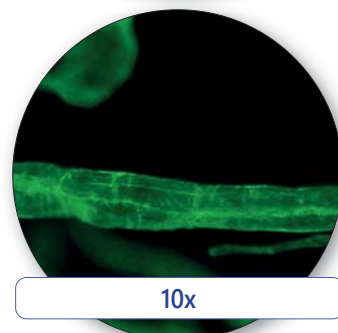

10x

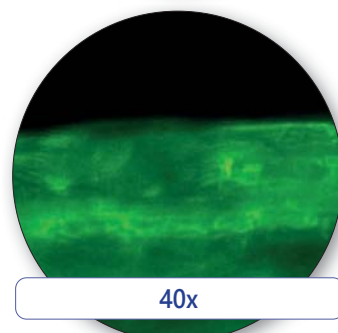

40x

Standard filterset

Name	Excitation filter (nm)	Dichroic mirror cut-off (nm)	Emission filter (nm)
B Blue	460 – 490	505	515LP

Part	Description
Observation mode:	Brightfield, LED fluorescence.
Epi-illumination and filter:	High-power blue LED with brightness control. 3-position filter holder; blue included.
Head:	Trinocular (fixed 50/50), 30° inclined, 360° rotating.
Interpupillary distance:	Adjustable between 48 and 75 mm.
Dioptric adjustment:	On the left eyepiece tube.
Eyepieces:	WF10x/20 mm, high eye-point and secured by screw.
Nosepiece:	Quintuple revolving nosepiece, rotation on ball bearings.
Objectives:	IOS N-PLAN 4x/0.10 IOS N-PLAN 10x/0.25 IOS N-PLAN 40x/0.65 IOS N-PLAN 100x/1.25 (Oil/Water) All with anti-fungus treatment.

Part	Description
Specimen stage:	Double layer rackless mechanical stage, 233x147 mm, 78x54 mm X-Y range.
Focusing:	Coaxial coarse (adjustable tension) and fine focusing mechanism with limit stop to prevent the contact between objective and specimen.
Condenser:	Abbe N.A. 1.25, with objective-coded iris diaphragm, focusable and centerable.
Transmitted illumination (Fixed Koehler type):	X-LED ³ with white 3.6 W LED (6,300K) with brightness control. Multi-plug 100-240Vac/6Vdc external power supply.

B-510FL - HBO Fluorescence Microscope

Advanced routine laboratory microscope for brightfield and fluorescence observations with Semi-Apo IOS W-PLAN F objectives to enhance the visibility of the sample and increase the overall contrast. The **HBO fluorescence** illuminator provides an outstanding flexibility of use, standing the blue and green filter sets (supplied as standard) for Auramine, FITC, GFP and YFP (with blue filter set) plus Rhodamine, Texas Red and TRITC (with the green one), yet giving the possibility to combine any other specific filter sets for future upgrade. Transmitted light through the exclusive **X-LED³** to ensure great-looking, rich and high-quality specimen view.

-  22
- 
- 
- 
- 
- 
- 

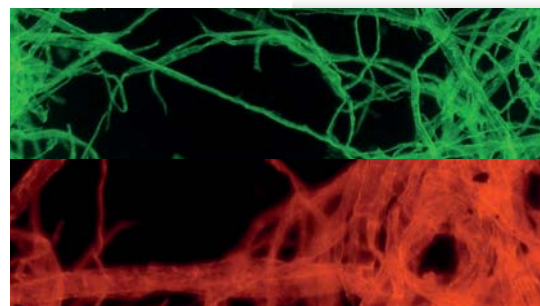

Standard filterset

Name	Excitation filter (nm)	Dichroic mirror cut-off (nm)	Emission filter (nm)
B Blue	460 - 490	505	515LP
G Green	510 - 550	570	575LP

Additional filterset (optional)

Name	Excitation filter (nm)	Dichroic mirror cut-off (nm)	Emission filter (nm)
V (Violet)	390 - 420	440	455LP
UV	325 - 375	415	435LP

Part	Description
Observation mode:	Brightfield, HBO fluorescence.
Epi-illumination and filter:	HBO 100 W high pressure mercury lamp. 4-position filter holder; blue & green included.
Head:	Trinocular (3-position 100/0, 50/50, 0/100), 30° inclined, 360° rotating.
Interpupillary distance:	Adjustable between 50 and 75 mm.
Dioptric adjustment:	On the left eyepiece tube.
Eyepieces:	WF10x/22 mm, high eye-point and with rubber cups.
Nosepiece:	Quintuple revolving nosepiece, rotation on ball bearings.
Objectives:	IOS W-PLAN F 4x/0.13 IOS W-PLAN F 10x/0.30 IOS W-PLAN F 20x/0.50 IOS W-PLAN F 40x/0.75 All with anti-fungus treatment.

Part	Description
Specimen stage:	Double layer rackless mechanical stage, 233x147 mm, 78x54 mm X-Y range.
Focusing:	Coaxial coarse (adjustable tension) and fine focusing mechanism with limit stop to prevent the contact between objective and specimen.
Condenser:	Swing-out N.A. 0.2/0.9, with iris diaphragm, focusable and centerable.
Transmitted illumination (Full Koehler type):	X-LED ³ with white 3.6 W LED (6,300K) with brightness control. Multi-plug 100-240Vac/6Vdc external power supply.

B-510LD4 - LED Fluorescence Microscope

Advanced routine fluorescence microscope for transmitted brightfield and fluorescence observations with IOS W-PLAN objectives. The extremely powerful LED Fluorescence Illuminators are combined with corresponding excitation filter sets for the visualization of most fluorochromes. LED fluorescence ensures unparalleled convenience eliminating warm-up/cool-down times and all the inconveniences related lamp replacement and adjustment. Transmitted light through the exclusive **X-LED³** to ensure great-looking, rich and high-quality specimen view.

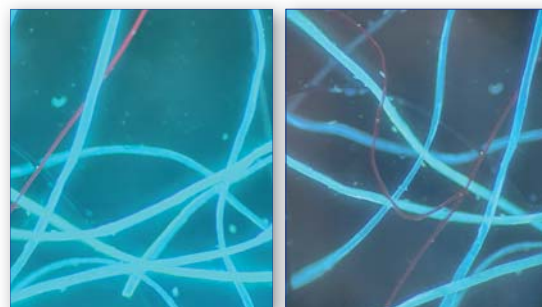
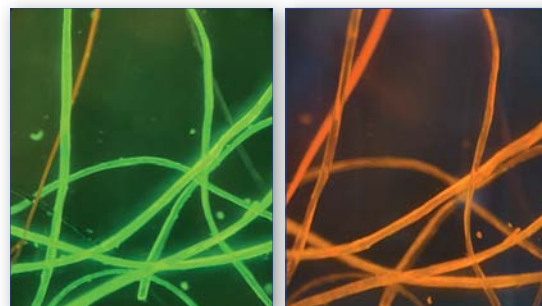

A new milestone achieved in Fluorescence Microscopy

- » Full-modular Fluorescence System
- » Interchangeable LED-Filtersets
- » 4 LED-Filtersets slots
- » 10% higher light intensity than HBO
- » 35% higher light intensity than Metal-Halide
- » Adjustable light intensity
- » The selection of filtersets automatically involves the switching on of the corresponding LEDs
- » Cost-effective, money saving technology
- » Ready for immediate operation
- » Eliminate warm-up/cool-down times
- » Forget lamp replacement & centering

Part	Description
Observation mode:	Brightfield, LED fluorescence.
Epi-illumination and filter:	High-power LED with brightness control. 4-position filter holder; none included.
Head:	Trinocular (3-position 100/0, 50/50, 0/100), 30° inclined, 360° rotating.
Interpupillary distance:	Adjustable between 50 and 75 mm.
Dioptric adjustment:	On the left eyepiece tube.
Eyepieces:	WF10x/22 mm, high eye-point and with rubber cups.
Nosepiece:	Quintuple revolving nosepiece, rotation on ball bearings.
Object.: B-510LD4:	IOS W-PLAN 4x/0.10 IOS W-PLAN 10x/0.25 IOS W-PLAN 40x/0.65 IOS W-PLAN 100x/1.25 (Oil)
B-510LD4-SA:	IOS W-PLAN F 4x/0.13 IOS W-PLAN F 10x/0.30 IOS W-PLAN F 40x/0.75 IOS W-PLAN F 100x/1.3 (Oil)
	All with anti-fungus treatment.

Part	Description
Specimen stage:	Double layer rackless mechanical stage, 233x147 mm, 78x54 mm X-Y range.
Focusing:	Coaxial coarse (adjustable tension) and fine focusing mechanism with limit stop to prevent the contact between objective and specimen.
Condenser:	Swing-out N.A. 0.2/0.9, with iris diaphragm, focusable and centerable.
Transmitted illumination (Full Koehler type):	X-LED ³ with white 3.6 W LED (6,300K) with brightness control. Multi-plug 100-240Vac/6Vdc external power supply.

B-510LD4 - LED Fluorescence Microscope

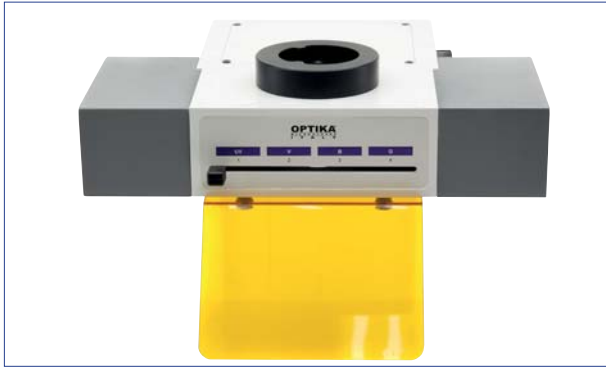

OPTIKA LED Fluorescence attachment is a revolutionary solution. It consists of a 4-position selector for the use of 4 fluorescent illuminators, called LED Fluorescence Cubes. Each Cube is composed of a filterset mounted on a filterblock and a high power LED with emission corresponding to the filters installed. In this way the selection of each filter controls the lighting up of the corresponding LED.

The microscope is supplied without any LED Fluorescence Cube. A selection of 9 types is available, as shown in the table below.

B-510LD4
Trinocular brightfield microscope, 1000x,
IOS W-PLAN objectives

B-510LD4-SA
Trinocular brightfield microscope, 1000x,
IOS W-PLAN F (Semi-Apo) objectives. **For UV Fluorescence**



M-1220 ... M-1228
LED Fluorescence Cubes (LED + Filterset)

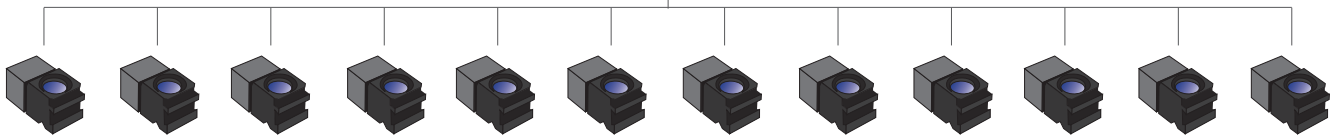

LED Fluorescence Cubes available (LED + Filterset)

Name	LED emission (nm)	Excitation filter (nm)	Dichroic mirror cut-off (nm)	Emission filter (nm)
M-1220 - Blue	460	455 - 495	500	510LP
M-1220.1 - Blue (pass band)	460	455 - 495	500	518-542
M-1221 - Green	523	510 - 550	570	575LP
M-1221.1 - Green (pass band)	523	510 - 550	570	585-625
M-1222 - Violet	405	390 - 420	440	450LP
M-1223 - UV	365	325 - 375	415	435LP
M-1223.1 - UV (pass band)	365	340 - 390	405	420-470
M-1224 - Red 1	623	590 - 650	660	665LP
M-1225 - Red 2	623	595 - 645	655	665 - 715
M-1226 - Deep Red	660	623 - 678	685	690 - 750
M-1227 - Far Red	740	720 - 760	770	780LP
M-1228 - Amber	590	582 - 603	610	615 - 645

2 OPTIKA B-1000FL-HBO - HBO Fluorescence Microscope

The modular OPTIKA B-1000 can stand a HBO fluorescence attachment, helping you working in a comfortable way during extended periods of use and performing reliable, accurate and rapid diagnosis benefiting from modularity, which gives the chance to create customized configurations tailored on customer needs. Versatile, robust, durable and sturdy, B-1000 offers premium quality optics (including Semi-Apo objectives), the state-of-the-art, exclusive **X-LED⁸** (8 W) illumination system, designed by OPTIKA and the Koehler diaphragm.

B-1000 gives multiple options as manual or motorized configuration, with a variety of objectives, stages and condensers.

Standard filterset

Name	Excitation filter (nm)	Dichroic mirror cut-off (nm)	Emission filter (nm)
B Blue	460 - 490	500	520LP
G Green	510 - 550	570	590LP

Additional filterset (optional)

Name	Excitation filter (nm)	Dichroic mirror cut-off (nm)	Emission filter (nm)
V (Violet)	400 - 410	455	455LP
UV	330 - 385	400	420LP



B-1000FL-HBO - Configuration Chart

Build the microscope that suites your needs by choosing among the components

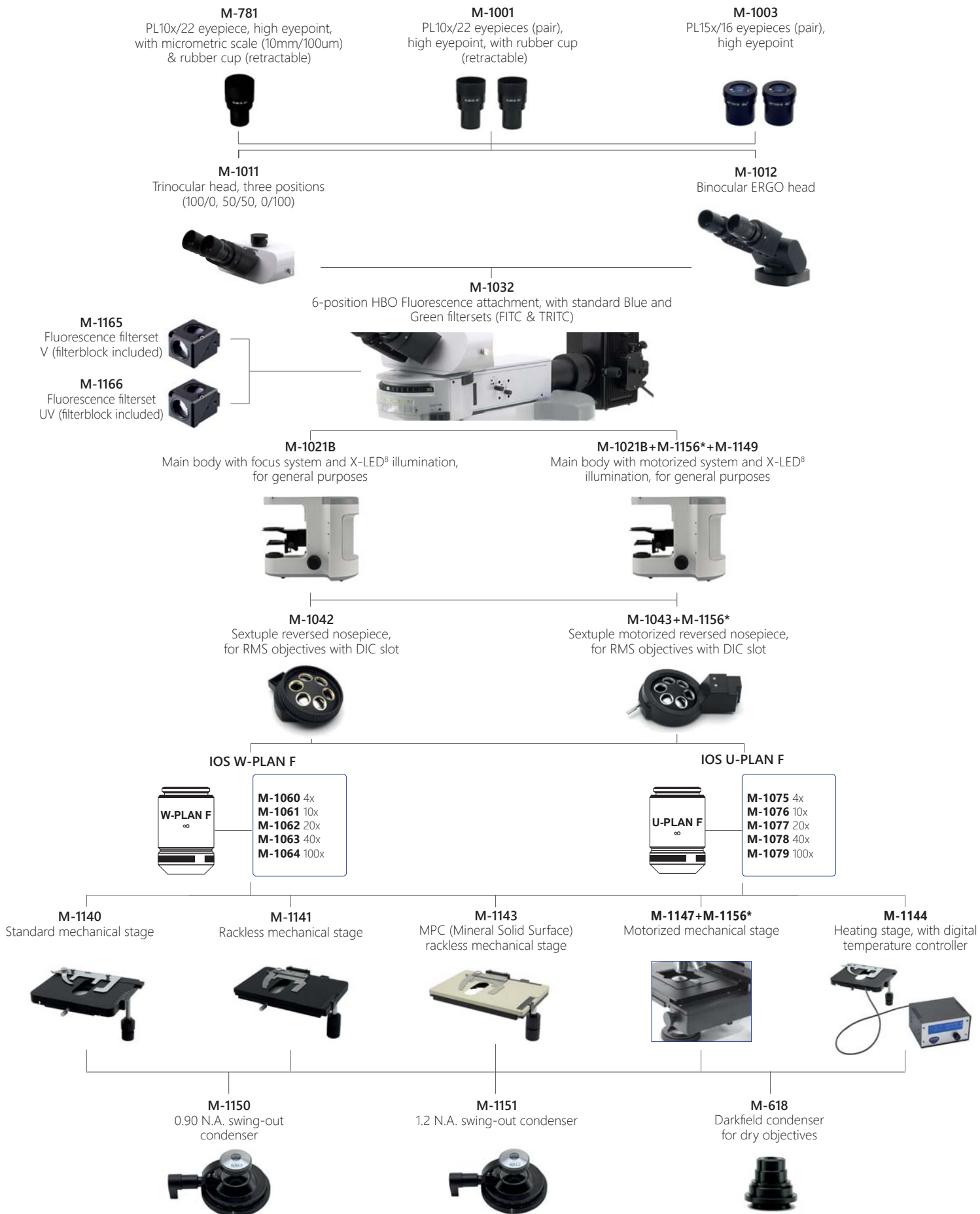

* Code M-1156 must be added only **once** for any motorized configuration

B-1000LD4 - LED Fluorescence Microscope

The modular OPTIKA B-1000 can stand a LED fluorescence attachment, helping you working in a comfortable way during extended periods of use and performing reliable, accurate and rapid diagnosis benefiting from modularity, which gives the chance to create customized configurations tailored on customer needs. Versatile, robust, durable and sturdy, B-1000 offers premium quality optics (including Apo and Semi-Apo objectives), the state-of-the-art, exclusive **X-LED³** (8 W) illumination system, designed by OPTIKA and the Koehler diaphragm. B-1000 gives multiple options as manual or motorized configuration, with a variety of objectives, stages and condensers.

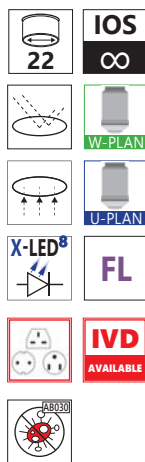

A new milestone achieved in Fluorescence Microscopy

- » Full-modular Fluorescence System
- » Interchangeable LED-Filtersets
- » 4 LED-Filtersets slots
- » 10% higher light intensity than HBO
- » 35% higher light intensity than Metal-Halide
- » Adjustable light intensity
- » The selection of filtersets automatically involves the switching on of the corresponding LEDs
- » Recommended for research applications
- » Cost-effective, money saving technology
- » Ready for immediate operation
- » Eliminate warm-up/cool-down times
- » Forget lamp replacement & centering

LED Fluorescence Cubes available (LED + Filterset)

Name	LED emission (nm)	Excitation filter (nm)	Dichroic mirror cut-off (nm)	Emission filter (nm)
M-1220 - Blue	460	455 - 495	500	510LP
M-1220.1 - Blue (pass band)	460	455 - 495	500	518-542
M-1221 - Green	523	510 - 550	570	575LP
M-1221.1 - Green (pass band)	523	510 - 550	570	585-625
M-1222 - Violet	405	390 - 420	440	450LP
M-1223 - UV	365	325 - 375	415	435LP
M-1223.1 - UV (pass band)	365	340 - 390	405	420-470
M-1224 - Red 1	623	590 - 650	660	665LP
M-1225 - Red 2	623	595 - 645	655	665 - 715
M-1226 - Deep Red	660	623 - 678	685	690 - 750
M-1227 - Far Red	740	720 - 760	770	780LP
M-1228 - Amber	590	582 - 603	610	615 - 645

B-1000LD4 - Configuration Chart

Build the microscope that suites your needs by choosing among the components

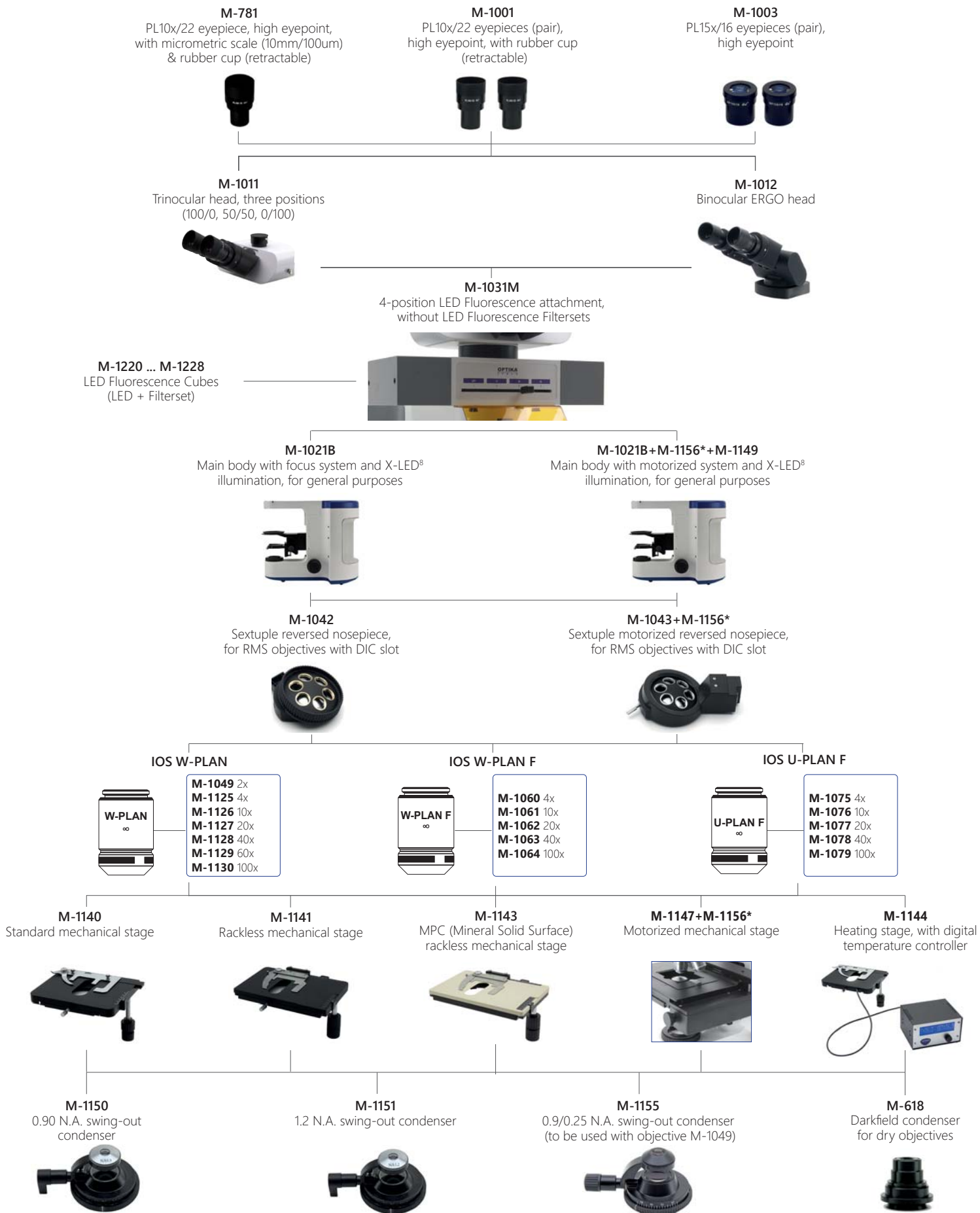

* Code M-1156 must be added only **once** for any motorized configuration

Fluorescence Filtersets

Name	Excitation filter (nm)	Dichroic mirror cut-off (nm)	Emission filter (nm)
B (Blue)	460 – 490	505	515LP
G (Green)	510 – 550	570	575LP
V (Violet) optional	385 – 425	440	455LP
UV (Ultraviolet) optional	325 – 375	415	435LP

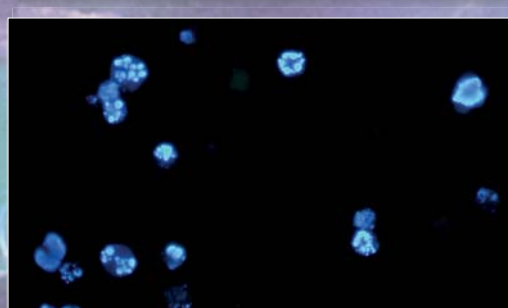
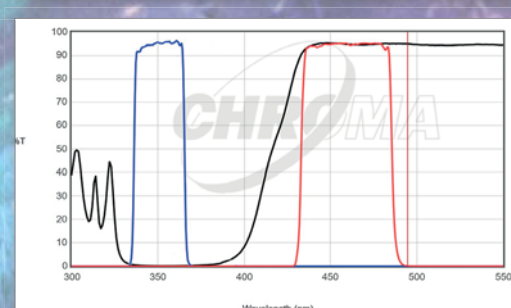
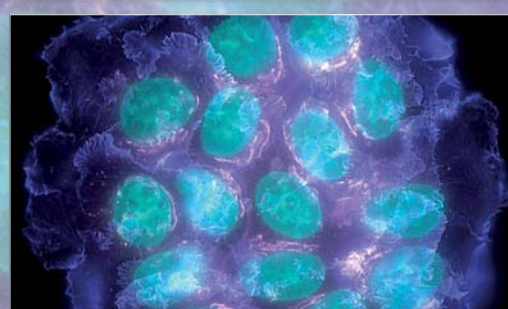
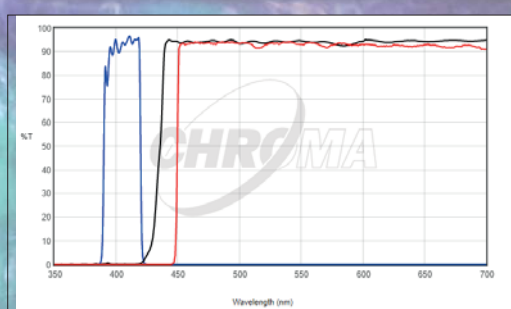
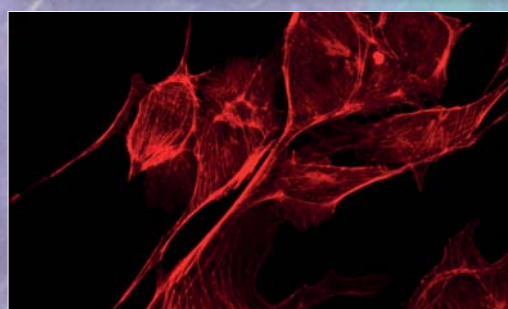
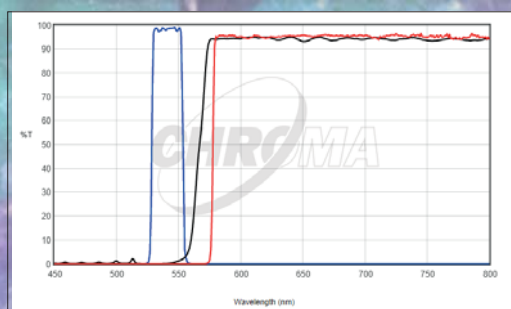
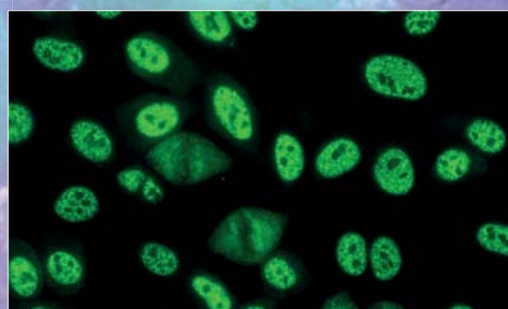
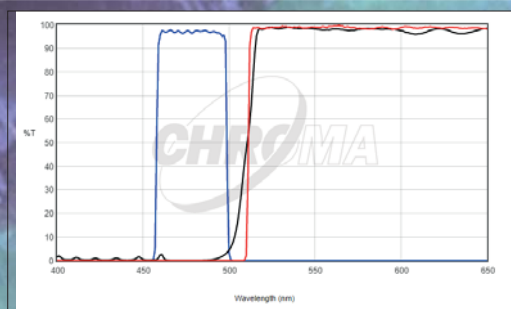

**MANY MORE FILTERSETS
AVAILABLE ON REQUEST**

CHROMA TECHNOLOGY CORP
THE WORLD'S FINEST OPTICAL FILTERS

Specs are of B-510FL Filtersets

IM-3F - HBO Fluorescence Microscope

Routine inverted fluorescence microscope for transmitted brightfield, phase contrast and fluorescence observations with IOS LWD W-PLAN objectives. The HBO fluorescence illuminator is combined with blue and green excitation filter set for the visualization of the following fluorochromes: Acridine Yellow, Acridine Orange, Auramine, DiO, DTAF, FITC, GFP, YFP, etc. (blue) plus Rhodamine, Texas Red and TRITC (green). Transmitted light through the exclusive **X-LED[®]** to ensure great-looking, rich and high-quality specimen view.

-  22
- 
- 
-  X-LED[®]
-  IOS
-  W-PLAN
-  FL
-  PH
- 

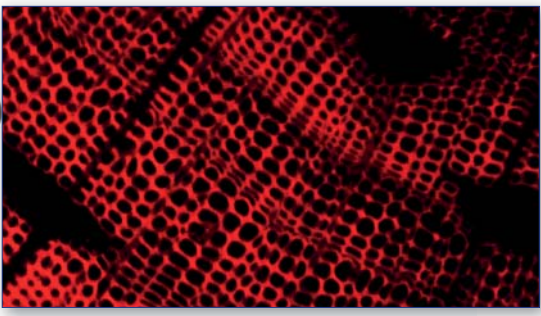
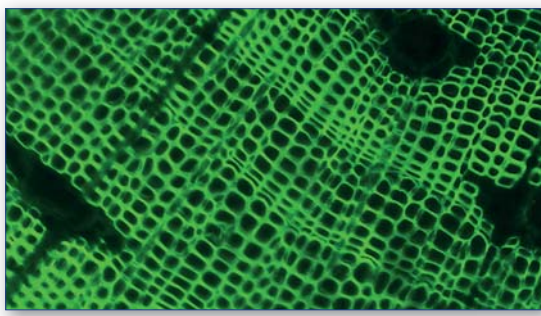

Standard filtersets

Name	Excitation filter (nm)	Dichroic mirror cut-off (nm)	Emission filter (nm)
B (Blue)	450 – 490	495	520LP
G (Green)	527 – 553	565	575LP



Part	Description
Observation mode:	Brightfield, phase contrast, HBO fluorescence.
Epi-illumination and filter:	HBO 100 W high pressure mercury lamp. 3-position filter holder; blue & green included.
Head:	Trinocular (2-position 100/0, 0/100), 45° inclined.
Interpupillary distance:	Adjustable between 50 and 75 mm.
Dioptric adjustment:	On the left eyepiece tube.
Eyepieces:	WF10x/22 mm, high eye-point and with rubber cups.
Nosepiece:	Quintuple revolving nosepiece, rotation on ball bearings.
Objectives:	IOS LWD W-PLAN 4x/0.13 IOS LWD W-PLAN PH 10x/0.25 IOS LWD W-PLAN PH 20x/0.40 IOS LWD W-PLAN 40X/0.60 All with anti-fungus treatment.

Part	Description
Specimen stage:	Fixed stage, 250x160 mm, with glass and metal stage inserts.
Focusing:	Coaxial coarse (adjustable tension) and fine focusing mechanism with limit stop to prevent the contact between objective and specimen.
Condenser:	LWD pre-centered condenser, N.A. 0.30, W.D. 72 mm. With 4x/10x, 20x/40x phase contrast slider and brightfield. Removable to extend the working distance up to 150 mm.
Transmitted illumination:	X-LED [®] with white 8 W LED (6,300K) with brightness control. With aperture diaphragm. Multi-plug 100-240Vac/6Vdc external power supply.

IM-3FL4 - HBO Fluorescence Microscope

Advanced inverted microscope for brightfield and fluorescence observations with Semi-Apo IOS LWD U-PLAN F objectives to enhance the visibility of the sample and increase the overall contrast. The HBO fluorescence illuminator provides an outstanding flexibility of use, standing the blue and green filter sets (supplied as standard) for Auramine, FITC, GFP and YFP (with blue filter set) plus Rhodamine, Texas Red and TRITC (with the green one), yet giving the possibility to combine any other specific filter sets for future upgrade. Transmitted light through the exclusive **X-LED⁸** to ensure great-looking, rich and high-quality specimen view.

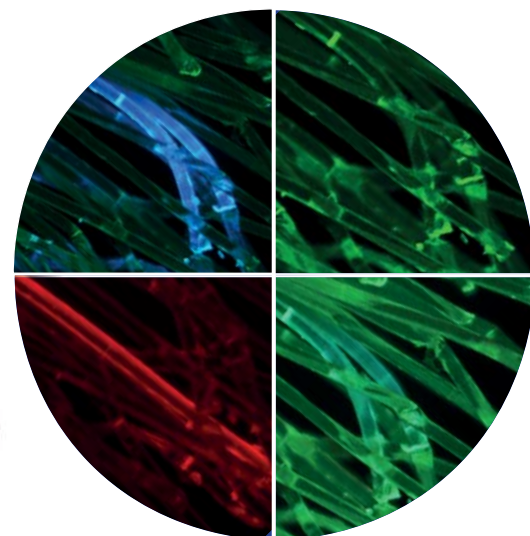

Standard filterset

Name	Excitation filter (nm)	Dichroic mirror cut-off (nm)	Emission filter (nm)
B Blue	460 - 490	500	520LP
G Green	527 - 553	565	575LP

Additional filterset (optional)

Name	Excitation filter (nm)	Dichroic mirror cut-off (nm)	Emission filter (nm)
V (Violet)	390 - 420	440	455LP
UV	325 - 375	415	435LP

Part	Description
Observation mode:	Brightfield, HBO fluorescence.
Epi-illumination and filter:	HBO 100 W high pressure mercury lamp. 4-position filter holder; blue & green included.
Head:	Trinocular (2-position 100/0, 0/100), 45° inclined.
Interpupillary distance:	Adjustable between 50 and 75 mm.
Dioptric adjustment:	On the left eyepiece tube.
Eyepieces:	WF10x/22 mm, high eye-point and with rubber cups.
Nosepiece:	Quintuple revolving nosepiece, rotation on ball bearings.
Objectives:	IOS LWD U-PLAN F 10x/0.30 IOS LWD U-PLAN F 20x/0.45 IOS LWD U-PLAN F 40x/0.65 All with anti-fungus treatment.

Part	Description
Specimen stage:	Fixed stage, 250x160 mm, with glass and metal stage inserts.
Focusing:	Coaxial coarse (adjustable tension) and fine focusing mechanism with limit stop to prevent the contact between objective and specimen.
Condenser:	LWD pre-centered condenser, N.A. 0.30, W.D. 72 mm. Removable to extend the working distance up to 150 mm.
Transmitted illumination:	X-LED ⁸ with white 8 W LED (6,300K) with brightness control. With aperture diaphragm. Multi-plug 100-240Vac/6Vdc external power supply.

IM-3LD2 - LED Fluorescence Microscope

Routine inverted fluorescence microscope for transmitted brightfield, phase contrast and fluorescence observations with IOS LWD W-PLAN PH objectives. The LED fluorescence illuminators are combined with blue and green excitation filter set for the visualization of the following fluorochromes: Acridine Yellow, Acridine Orange, Auramine, DiO, DTAF, FITC, GFP, YFP, etc. (blue) plus Rhodamine, Texas Red and TRITC (green). LED fluorescence ensures unparalleled convenience eliminating warm-up/cool-down times and all the inconveniences related lamp replacement and adjustment. Transmitted light through the exclusive **X-LED[®]** to ensure great-looking, rich and high-quality specimen view.

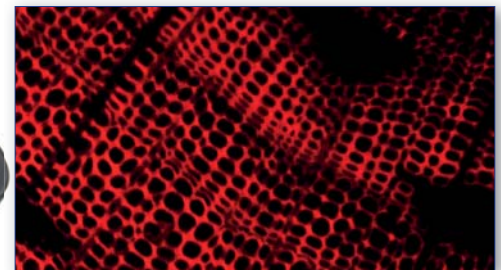
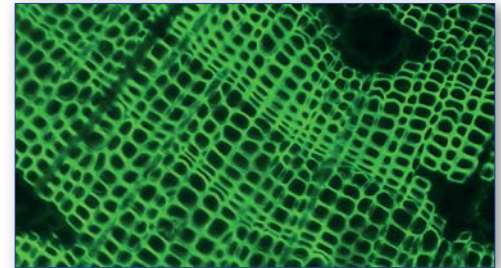

A new milestone achieved in Fluorescence Microscopy

- » 10% higher light intensity than HBO
- » 35% higher light intensity than Metal-Halide
- » Adjustable light intensity
- » The selection of filtersets automatically involves the switching on of the corresponding LEDs
- » Recommended for routine applications
- » Cost-effective, money saving technology
- » Ready for immediate operation
- » Eliminate warm-up/cool-down times
- » Forget lamp replacement & centering

LED Fluorescence Cubes (LED + Filterset) included

Name	LED emission (nm)	Excitation filter (nm)	Dichroic mirror cut-off (nm)	Emission filter (nm)
Blue	460	455 - 495	500	510LP
Green	523	510 - 550	570	575LP

Part	Description
Observation mode:	Brightfield, phase contrast, LED fluorescence.
Epi-illumination and filter:	High-power LED with brightness control. 3-position filter holder; blue and green filtersets included.
Head:	Trinocular (2-position 100/0, 50/50), 45° inclined.
Interpupillary distance:	Adjustable between 50 and 75 mm.
Dioptric adjustment:	On the left eyepiece tube.
Eyepieces:	WF10x/22 mm, high eye-point and with rubber cups.
Nosepiece:	Quintuple revolving nosepiece, rotation on ball bearings.
Objectives:	IOS LWD W-PLAN PH 10x/0.25 IOS LWD W-PLAN PH 20x/0.40 IOS LWD W-PLAN PH 40x/0.65 All with anti-fungus treatment.

Part	Description
Specimen stage:	Fixed stage, 250x160 mm, with glass and metal stage inserts. Mechanical stage as option.
Focusing:	Coaxial coarse (adjustable tension) and fine focusing mechanism with limit stop to prevent the contact between objective and specimen.
Condenser:	LWD pre-centered condenser, N.A. 0.30, W.D. 72 mm. With 4x/10x, 20x/40x phase contrast slider and brightfield. Removable to extend the working distance up to 150 mm.
Transmitted illumination:	X-LED [®] with white 8 W LED (6,300K) with brightness control. With aperture diaphragm. 100-240Vac/12Vdc external power supply.

IM-3LD4 - LED Fluorescence Microscope

Advanced fluorescence inverted microscope for transmitted brightfield and fluorescence observations with IOS LWD U-PLAN F objectives. The extremely powerful LED Fluorescence Illuminators are combined with corresponding excitation filter sets for the visualization of most fluorochromes. LED fluorescence ensures unparalleled convenience eliminating warm-up/cool-down times and all the inconveniences related lamp replacement and adjustment. Transmitted light through the exclusive **X-LED[®]** to ensure great-looking, rich and high-quality specimen view.



A new milestone achieved in Fluorescence Microscopy

- » Full-modular Fluorescence System
- » Interchangeable LED-Filtersets
- » 4 LED-Filtersets slots
- » 10% higher light intensity than HBO
- » 35% higher light intensity than Metal-Halide
- » Adjustable light intensity
- » The selection of filtersets automatically involves the switching on of the corresponding LEDs
- » Recommended for research applications
- » Cost-effective, money saving technology
- » Ready for immediate operation
- » Eliminate warm-up/cool-down times
- » Forget lamp replacement & centering

LED Fluorescence Cubes available (LED + Filterset)

Name	LED emission (nm)	Excitation filter (nm)	Dichroic mirror cut-off (nm)	Emission filter (nm)
M-1230 - Blue	460	455 - 495	500	510LP
M-1230.1 - Blue (pass band)	460	455 - 495	500	518-542
M-1231 - Green	523	510 - 550	570	575LP
M-1231.1 - Green (pass band)	523	510 - 550	570	585-625
M-1232 - Violet	405	390 - 420	440	450LP
M-1233 - UV	365	325 - 375	415	435LP
M-1233.1 - UV (pass band)	365	340 - 390	405	420-470
M-1234 - Red 1	623	590 - 650	660	665LP
M-1235 - Red 2	623	595 - 645	655	665 - 715
M-1236 - Deep Red	660	623 - 678	685	690 - 750
M-1237 - Far Red	740	720 - 760	770	780LP
M-1238 - Amber	590	582 - 603	610	615 - 645

Part	Description
Observation mode:	Brightfield, LED fluorescence.
Epi-illumination and filter:	High -Power LED with brightness control. 4-position filter holder; none included.
Head:	Trinocular (2-position 100/0, 50/50), 45° inclined.
Interpupillary distance:	Adjustable between 50 and 75 mm.
Dioptric adjustment:	On the left eyepiece tube.
Eyepieces:	WF10x/22 mm, high eye-point and with rubber cups.
Nosepiece:	Quintuple revolving nosepiece, rotation on ball bearings.
Objectives:	IOS LWD U-PLAN F 10x/0.30 IOS LWD U-PLAN F 20x/0.45 IOS LWD U-PLAN F 40x/0.65 All with anti-fungus treatment.

Part	Description
Specimen stage:	Mechanical stage, 250x290 mm, with glass and metal stage inserts for slides and 54mm dia. Petri dishes.
Focusing:	Coaxial coarse (adjustable tension) and fine focusing mechanism with limit stop to prevent the contact between objective and specimen.
Condenser:	LWD pre-centered condenser, N.A. 0.30, W.D. 72 mm. Removable to extend the working distance up to 150 mm.
Transmitted illumination:	X-LED [®] with white 8 W LED (6,300K) with brightness control. With aperture diaphragm. Multi-plug 100-240Vac/12Vdc external power supply.

IM-3LD4D - LED Fluorescence Microscope

Advanced fluorescence inverted microscope for transmitted brightfield and fluorescence observations with IOS LWD U-PLAN F objectives. The extremely powerful LED Fluorescence Illuminators are combined with corresponding excitation filter sets for the visualization of most fluorochromes. LED fluorescence ensures unparalleled convenience eliminating warm-up/cool-down times and all the inconveniences related lamp replacement and adjustment. Transmitted light through the exclusive **X-LED[®]** to ensure great-looking, rich and high-quality specimen view. This model is equipped with an Intel micro PC, a 12" screen, a 6Mpx high-sensitivity color camera, Optika ProView image analysis software for fluorescence and wireless mouse and keyboard.



A new milestone achieved in Fluorescence Microscopy

- » Full-modular Fluorescence System
- » Interchangeable LED-Filtersets
- » 4 LED-Filtersets slots
- » 10% higher light intensity than HBO
- » 35% higher light intensity than Metal-Halide
- » Adjustable light intensity
- » The selection of filtersets automatically involves the switching on of the corresponding LEDs
- » Recommended for research applications
- » Cost-effective, money saving technology
- » Ready for immediate operation
- » Eliminate warm-up/cool-down times
- » Forget lamp replacement & centering

LED Fluorescence Cubes available (LED + Filterset)

Name	LED emission (nm)	Excitation filter (nm)	Dichroic mirror cut-off (nm)	Emission filter (nm)
M-1230 - Blue	460	455 - 495	500	510LP
M-1230.1 - Blue (pass band)	460	455 - 495	500	518-542
M-1231 - Green	523	510 - 550	570	575LP
M-1231.1 - Green (pass band)	523	510 - 550	570	585-625
M-1232 - Violet	405	390 - 420	440	450LP
M-1233 - UV	365	325 - 375	415	435LP
M-1233.1 - UV (pass band)	365	340 - 390	405	420-470
M-1234 - Red 1	623	590 - 650	660	665LP
M-1235 - Red 2	623	595 - 645	655	665 - 715
M-1236 - Deep Red	660	623 - 678	685	690 - 750
M-1237 - Far Red	740	720 - 760	770	780LP
M-1238 - Amber	590	582 - 603	610	615 - 645

Part	Description
Observation mode:	Brightfield, LED fluorescence.
Epi-illumination and filter:	High -Power LED with brightness control. 4-position filter holder; none included.
Head:	Trinocular (2-position 100/0, 50/50), 45° inclined.
Interpupillary distance:	Adjustable between 50 and 75 mm.
Dioptric adjustment:	On the left eyepiece tube.
Eyepieces:	WF10x/22 mm, high eye-point and with rubber cups.
Nosepiece:	Quintuple revolving nosepiece, rotation on ball bearings.
Objectives:	IOS LWD U-PLAN F 10x/0.30 IOS LWD U-PLAN F 20x/0.45 IOS LWD U-PLAN F 40x/0.65 All with anti-fungus treatment.

Part	Description
Specimen stage:	Mechanical stage, 250x290 mm, with glass and metal stage inserts for slides and 54mm dia. Petri dishes.
Focusing:	Coaxial coarse (adjustable tension) and fine focusing mechanism with upper limit stop.
Condenser:	LWD pre-centered condenser, N.A. 0.30, W.D. 72 mm. Removable to extend the working distance up to 150 mm.
Transmitted illumination:	X-LED [®] with white 8 W LED (6,300K) with brightness control. With aperture diaphragm. Multi-plug 100-240Vac/12Vdc external power supply.
Digital equipment:	Intel micro PC with Image analysis software for Fluorescence. 12" screen; 6Mpx high-sensitivity color camera. Supplied with wireless mouse & keyboard.

IM-5FLD - LED Fluorescence Microscope

Phase contrast, brightfield and darkfield (dry) LED fluorescence trinocular inverted microscope, with freely configurable lenses according to customer's preferences, FN 24 high eyepoint, infinity corrected optical system, coaxial focusing, mechanical stage, Abbe condenser and powerful, uniform, white color temperature 8 W **X-LED8**. The 4-position epi-fluorescence attachment is powered by extremely powerful 5 W LEDs fluorescence illuminator and combined with blue, green and UV excitation filters for the visualization of the following fluorochromes: Acridine Yellow, Acridine Orange, Auramine, DiO, DTAF, FITC, GFP, YFP (blue filter) plus Rhodamine, Texas Red and TRITC (green filter) plus Alexa Fluor® 350, 7- Amino-4-methylcoumarin, 6-Aminoquinoline, Calcofluor® White, Dansyl cadaverine, DAPI, Dapoxyl, DIDS, Europium (III) Chloride, Fluoro-Gold™, Fura-2, Hoechst 33342 & 33258, 1,5 IAEDANS, Indo-1, Marina Blue®, 4-Methylumbelliferone, PBF1, Pyrene, SBF1, Y66F, Y66H (UV filter) among the others. LED fluorescence ensures unparalleled convenience eliminating warm-up/cool-down times and all the inconveniences related lamp replacement and adjustment. Sturdy and incredibly reliable, it is equipped with all the main controls in ergonomic position and with long lasting, efficient LED illumination to provide over 20 years of use.



IM-5FLD - Specifications



Part	Description
Head:	Trinocular (split ratio: 100/0, 0/100), 45° inclined.
Dioptric adjustment:	Both eyepieces.
Eyepieces:	WF10x/24 mm, high eyepoint and with retractable rubber cups.
Epi-fluorescence illumination & filters:	High-power 5 W LEDs with brightness control, motorized LED selection with centrable field diaphragm, 4-position filter holder; blue (EX 450-490, DM 495, EM 500-550), green (EX 540-580, DM 585, EM 608-682) and UV (EX 340-390, DM 400, EM 420LP) excitation filters included.
Nosepiece:	Quintuple ball bearings revolving nosepiece, reversed.
Objectives:	Selectable according to customer's preferences. All with anti-fungus treatment.
Specimen stage:	Fixed stage, 215x250 mm and attachable mechanical stage, 290x250 mm, 120x80 mm X-Y movement range.
Focusing:	Coaxial coarse and fine focusing mechanism with limit stop to prevent the contact between objective and specimen. Adjustable tension of coarse focusing knob.
Condenser:	Abbe N.A. 0.50, removable, with iris diaphragm and slider for phase contrast.
Transmitted illumination (Full Koehler):	X-LED [®] with white 8 W LED and brightness control. Color temperature: 6,300 K. Multi-plug 100-240Vac/12Vdc external power supply.

Fluorescence filtersets

Name	Excitation filter (nm)	Dichroic mirror cut-off (nm)	Emission filter (nm)
B (Blue)	450 – 490	495	500 - 550
G (Green)	540 – 580	585	607 - 682
UV (Ultraviolet)	340 -390	400	420LP

IM-5FLD is freely configurable in terms of objectives, by choosing among:

Included ■ Optional □

Infinity-corrected Plan-Achromatic, Long Working Distance objectives, field flatness up to F.N. 22:		
M-782	IOS LWD W-PLAN objective 4x/0.13	□
M-773	IOS LWD W-PLAN objective 40x/0.60	□
M-786	IOS LWD W-PLAN objective 60x/0.70	□

Infinity-corrected Semi-Apochromatic, Long Working Distance objectives, field flatness up to F.N. 25:		
M-800	IOS LWD U-PLAN F objective 4x/0.13	□
M-801	IOS LWD U-PLAN F objective 10x/0.30	□
M-802	IOS LWD U-PLAN F objective 20x/0.45	□
M-803	IOS LWD U-PLAN F objective 40x/0.65	□
M-804	IOS LWD U-PLAN F objective 60x/0.75	□

Positive Phase Contrast Infinity-corrected Plan-Achromatic, Long Working Distance objectives, field flatness up to F.N. 22:		
M-782.1	IOS LWD W-PLAN PH objective 4x/0.13	□
M-783N	IOS LWD W-PLAN PH objective 10x/0.25	□
M-784N	IOS LWD W-PLAN PH objective 20x/0.40	□
M-785	IOS LWD W-PLAN PH objective 40x/0.65	□

Positive Phase Contrast Infinity-corrected Semi-Apochromatic, Long Working Distance objectives, field flatness up to F.N. 25:		
M-1177	IOS LWD U-PLAN F PH objective 20x/0.45	□
M-1178	IOS LWD U-PLAN F PH objective 40x/0.65	□

v 6.7 - OPTIKA reserves the right to make corrections, modifications, enhancements, improvements and other changes to its products at any time without notice.

Headquarters and Manufacturing Facilities

OPTIKA® S.r.l. Via Rigla, 30 - 24010 Ponteranica (BG) - ITALY - Tel.: +39 035.571.392 - info@optikamicroscopes.com

Optika Sales branches

OPTIKA® Spain spain@optikamicroscopes.com

OPTIKA® China china@optikamicroscopes.com

OPTIKA® India india@optikamicroscopes.com

OPTIKA® USA usa@optikamicroscopes.com

OPTIKA® Central America camerica@optikamicroscopes.com

OPTIKA®
MICROSCOPES
I T A L Y

SZR-180



Research Stereomicroscope

SZR-180- Features



18:1 Zoom Ratio

The SZR-180 with its 18:1 zoom ratio puts it at the top of its class. The wide range of magnifications available (7.5x-135x), coupled with a precise click-stop mechanism for working with reproducible zoom settings, makes it ideal for both low-magnification observation and high-magnification screening and observation of small cell structures.

PLAN APO 1x objective

The Plan APO 1x apochromatic main objective provides high-resolution images at both low and high magnifications, making it ideal for observing and capturing images of the smallest details free of aberrations and halos. Combined with the zoom and the generous 23mm field number eyepieces, this provides a large FOV even at high magnifications (1.7mm).



Ergonomic stand with diasopic LED lighting

Ergonomically designed, the SZR-180's wide base offers a huge space for sample holders, intuitive controls and an extremely low profile for easy access and reduced fatigue-free body movement. The LED diasopic illumination is designed to achieve high overall contrast and includes the innovative OIC (Oblique Illumination Contrast) system, ideal for transparent structures, and dark-field illumination.

SZR-180- Specifications

The SZR-180 is the top-of-the-range stereo zoom microscope dedicated to the world of research. With a wide magnification range and high optical resolution combined with effective ergonomics, the SZR-180 is the perfect companion in advanced research. The 18:1 zoom allows you to observe a wide range of samples, from single cells to entire microorganisms.

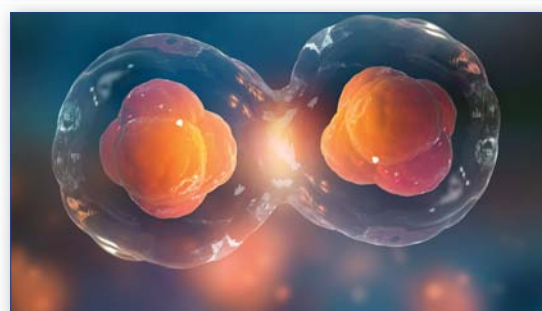
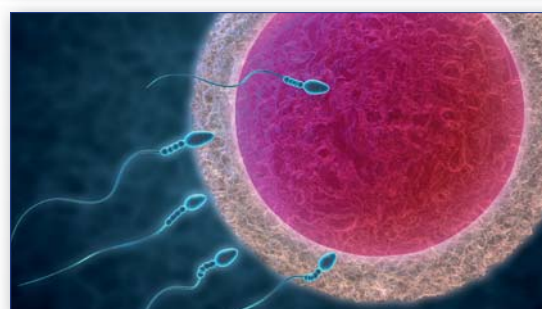

Part	Description
Head:	Trinocular 100/0 - 0/100 (on right tube), 20° inclined.
Interpupillary distance:	52-112 mm.
Dioptric adjustment:	Both eyepieces.
Eyepieces:	WF10x/23 mm, high eyepoint with rubber cups.
Objective:	PLAN Apochromatic 1x, N.A. 0.15, 7.5x-135x (zoom ratio 18:1), zoom click stops at 0.75x, 1x, 2x, 3x, 6x, 10x, 13.5x with aperture diaphragm.
Working distance:	60 mm.
Stand:	High-grade, precision fixed with handle and focus.
Focusing:	Coaxial coarse & fine, coarse total travel 125 mm, fine single rotation 2 mm. Rack and pinion focusing mechanism.
Stage:	Glass transparent plate for transmitted illumination diameter 180 mm.
Illumination:	LED transmitted, with OIC (Oblique Illumination Contrast) and darkfield illumination. Multi-plug 100-240Vac/12Vdc external power supply.

SZR-180 - Optical Performance

Eyepiece	10x	
Field number (mm)	23	
Objective	Total magnification	Field of View (mm)
1x (W.D: 60 mm)	7.5x-135x	30.60 - 1.70



SZR-180 - Accessories

Miscellaneous

- 15104 Cleaning kit
- DC-004 TNT dust cover, extra large, 700(l)x550(h) mm
- M-005 Micrometric slide, 26x76mm, with 2 scales (1mm/100 & 10mm/100)
- AB-030 Antibacterial surface treatment, only for newly purchased microscope

15104 - Cleaning kit

It cleans glass quickly and effectively, without leaving residue or odor. Ideal for precision lens or prism cleaning.



How to connect the cameras to our microscopes.
Please refer to the Adapter reference list on Digital section.

v 6.7 - OPTIKA reserves the right to make corrections, modifications, enhancements, improvements and other changes to its products at any time without notice.

Headquarters and Manufacturing Facilities

OPTIKA® S.r.l. Via Rigla, 30 - 24010 Ponteranica (BG) - ITALY - Tel.: +39 035.571.392 - info@optikamicroscopes.com

Optika Sales branches

OPTIKA® Spain spain@optikamicroscopes.com
OPTIKA® China china@optikamicroscopes.com
OPTIKA® India india@optikamicroscopes.com

OPTIKA® USA usa@optikamicroscopes.com
OPTIKA® Central America camerica@optikamicroscopes.com