

BIOBASE®

BIOBASE GROUP

Add: No.9 Gangxing Road, High-tech Zone,
Jinan City, Shandong Province, China

Tel: +86-531-81219803

E-mail: export@biobase.com

Website: www.biobase.cc / www.biobase.com



 **BIOBASE CHINA**

 **BIOBASE CHINA**

 **BIOBASE CHINA**

Version 2023-1

INTRODUCTION

BIOBASE Group is a professional manufacturer of laboratory products since 1999. Our main products are Biosafety Cabinet (Class I / II / III), Laminar Flow Cabinet, Fume Hood, Biochemistry Analyzer, Reagent, Autoclave and Incubator. We have more than 5000 employees and 14 factories. Our output per year reaches 20000 units. Pursuing the highest quality is the tenet of BIOBASE. We hope everybody will enjoy BIOBASE service to keep away from the infectious disease.

Our advantages:

- We built an excellent research team which consists of 150 professional engineers.
- We have 20 years production experience and a strong technical production team. And we adopt high-tech and state-of-the-art production equipment from Italy, Japan, and Switzerland, etc.
- We have a strong quality control team to inspect all production stage, from the purchased accessories to the finished products.
- We have full sets of advanced quality assurance equipments.
- We have ISO9001 quality management system; ISO14001 environment management system, ISO13485, CE mark, MET and NSF 49 certificate (BSC-4FA2, BSC-3FA2-GL, BSC-3FA2-NA, BSC-4FA2-GL, BSC-4FA2-NA, BSC-6FA2-GL, BSC-6FA2-NA).
- We got EN 12469 certificate (BSC-2FA2-HA, BSC-3FA2-HA, BSC-4FA2-HA, BSC-3FA2, BSC-4FA2) for Biosafety Cabinet in 2013.



CONTENTS

001	Class II A2 Biological Safety Cabinet
025	Class II B2 Biological Safety Cabinet
034	Cytotoxic Safety Cabinet
037	Class III Biological Safety Cabinet
040	Class I Biological Safety Cabinet
045	Laminar Flow Cabinet
064	Fume Hood
081	Clean Booth
083	Dispensing Booth
085	Pathology Workstation
087	Chicken Isolator
089	Air Purifier
091	Air Shower and Pass Box
093	Animal Cage Changing Station
095	Animal Litter Workstation
097	Mini PCR Workstation

Class II A2 Biological Safety Cabinet

Three protection: operator, sample and environment.
Airflow system: 70% air recirculation, 30% air exhaust
A2 Cabinet is suitable for working with microbiological research in the absence of volatile or toxic chemicals and radionuclide.

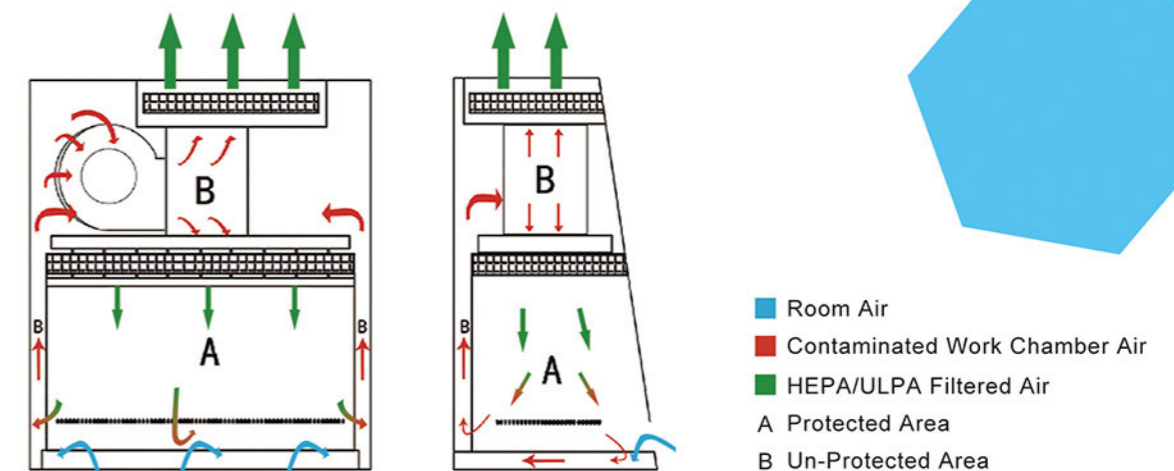

EN Certified Biological Safety Cabinet



Color Touch Screen
Touch operation, real-time and clearer display of various values and appointment timing function.



Anti-paper dust structure



Wind Speed Sensor



Stepper Motor



Work Zone
Work zone, made of 304 stainless steel, is surrounded by negative pressure.



Footmaster Caster
Universal caster with brake and leveling feet.



European Standard Socket



UV Lamp
Emission of 253.7 nanometers for most efficient decontamination.

ADVANTAGE

- 7-inch large touch color display: touch operation, real-time and clearer display of various values of the safety cabinet, dynamic air flow pattern diagram, fault alarm sound and light prompt.
- The power-on password can be set to prevent mis-operation by irrelevant personnel.
- Automatically adjust the wind speed.
- Power-off memory, restore the state before power-off, and have a visual reminder to alarm.
- Side windows on both sides for easy observation.
- The operation area is integrally formed, which is easy to disassemble and clean.
- A breeze speed sensor is equipped at the working area and the outer exhaust air outlet to detect the wind speed in real time.
- It can be used both manually and electrically, and the glass door can be pulled down to close the front window when the power is off.
- The cabinet is separated from the base. The height of the adjustable base can be customized.
- Interlocking function: UV lamp and front window; UV lamp and fan, fluorescent lamp; fan and front window.
- It has an appointment timing function, which can automatically set the timing of turning on, turning off and the running time of the UV lamp, fan, and socket.
- The closing of the front window can double trigger the signal, so that the sterilization and disinfection function of the UV lamp can be turned on normally.
- Anti-paper dust structure at the air inlet to prevent paper dust from entering the air cavity.
- Split countertop is easier to clean.
- One button front window lifting function.

TECHNICAL PARAMETERS

Model	BSC-2FA2-HA	
External Size(W*D*H)	700*700*2000mm	
Internal Size(W*D*H)	600*500*540mm	
Work Surface Height	750mm	
Max Opening Height	350mm	
Safe Operation Opening Height	200mm	
Airflow Volume	Inflow	230m ³ /h(135cfm)
	Down flow	65%: 428 m ³ /h(252cfm)
	Exhaust	35%: 230m ³ /h(135cfm)
Front Window	Manual and electric, glass thickness> 5mm, anti-ultraviolet	
ULPA Filter	2pcs, filtration efficiency for 0.12um particles≥99.9995%	
Illumination	≥1000Lux	
Noise	EN12469≤65dB	
Display	Color Touch Screen	
European Standard Socket	230V, 3A	
Power Supply	AC 230V, 50/60Hz	
Rated Power	950W	
Alarm	Alarm for abnormal wind speed, alarm for glass door not at safe height, alarm for abnormal power failure	
Motor	DC single fan, Adjustable speed, high efficiency, low power	
Material	Working Area: 304 stainless steel, side window glass; Frame and decorative plate: cold-rolled steel with anti-bacteria powder coating	
LED Lamp	8W*2	
UV Lamp	15W	
Standard Accessory	Cabinet*1, Base stand*1, LED lamp*2, UV lamp*1, Drain ball valve*1, European Standard Socket*2	
Optional Accessory	Arm rest, Formalin fumigation sterilizer, Infrared sterilizer S.S. water tap*2, S.S. gas tap*2	
Package Size (W*D*H)	850*880*1550mm	
Gross Weight	170kg	

EN Certified Biological Safety Cabinet



Color Touch Screen
Touch operation, real-time and clearer display of various values and appointment timing function.



SS Water tap & Gas tap



Anti-paper dust structure



Wind Speed Sensor



Footmaster Caster
Universal caster with brake and leveling feet.



Stepper Motor



European Standard Socket

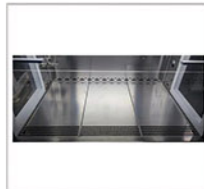

Work Zone
Work zone, made of 304 stainless steel, is surrounded by negative pressure.



UV Lamp
Emission of 253.7 nanometers for most efficient decontamination.

ADVANTAGE

- 7-inch large touch color display: touch operation, real-time and clearer display of various values of the safety cabinet, dynamic air flow pattern diagram, fault alarm sound and light prompt.
- The power-on password can be set to prevent mis-operation by irrelevant personnel.
- Automatically adjust the wind speed.
- Power-off memory, restore the state before power-off, and have a visual reminder to alarm.
- Side windows on both sides for easy observation.
- The operation area is integrally formed, which is easy to disassemble and clean.
- A breeze speed sensor is equipped at the working area and the outer exhaust air outlet to detect the wind speed in real time.
- It can be used both manually and electrically, and the glass door can be pulled down to close the front window when the power is off.
- The cabinet is separated from the base. The height of the adjustable base can be customized.
- Interlocking function: UV lamp and front window; UV lamp and fan, fluorescent lamp; fan and front window.
- It has an appointment timing function, which can automatically set the timing of turning on, turning off and the running time of the UV lamp, fan, and socket.
- The closing of the front window can double trigger the signal, so that the sterilization and disinfection function of the UV lamp can be turned on normally.
- The cabinet is designed with a 10° inclination angle, which conforms to the principle of ergonomics, has a larger viewing angle, is easy to operate and is more user-friendly.
- Anti-paper dust structure at the air inlet to prevent paper dust from entering the air cavity.
- Split countertop is easier to clean.
- One button front window lifting function.

TECHNICAL PARAMETERS

Model	BSC-3FA2-HA	BSC-4FA2-HA
External Size(W*D*H)	1087*800*2260mm	1383*800*2260mm
Internal Size(W*D*H)	980*600*650mm	1280*600*650mm
Work Surface Height	750mm	
Max Opening	500mm	
Tested Opening	200mm	
Airflow Volume	Inflow	370m³/h(218cfm)
	Down flow	65%: 690 m³/h(406cfm)
	Exhaust	35%: 370m³/h(218cfm)
Front Window	Manual and electric, glass thickness> 5mm, anti-ultraviolet	
ULPA Filter	2pcs, filtration efficiency for 0.12um particles≥99.9995%	
Illumination	≥1000Lux	
Noise	EN12469≤65dB	
Display	Color Touch Screen	
European Standard Socket	230V, 3A	
Power Supply	AC 230V, 50/60Hz	
Rated Power	1100W	1200W
Alarm	Alarm for abnormal wind speed, alarm for glass door not at safe height, alarm for abnormal power failure	
Motor	AC single fan, Adjustable speed, high efficiency, low power	
Material	Working Area: 304 stainless steel, side window glass; Frame and decorative plate: cold-rolled steel with anti-bacteria powder coating	
LED Lamp	12W*2	14W*2
UV Lamp	20W	30W
Standard Accessory	Cabinet*1, Base stand*1, LED lamp*2, UV lamp*1, S.S. water tap*1, S.S. gas tap*1, Drain ball valve*1, European Standard Socket*2	
Optional Accessory	Arm rest, Formalin fumigation sterilizer, Infrared sterilizer, Electric height adjustable base stand, S.S. water tap*1, S.S. gas tap*1	
Package Size (W*D*H)	1240*1060*1880mm	1530*1060*1880mm
Gross Weight	270kg	345kg

EN Certified Biological Safety Cabinet



LCD Display

Large LCD display is easy to monitor all the safety parameters at a glance; and ergonomically sized control panel improves users interface.



Remote Control for Convenient Operation

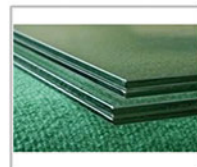

Front Window
Laminated toughened glass, Anti UV



Footmaster Caster
Universal caster with brake and leveling feet.



SS Water tap & Gas tap

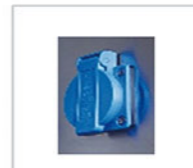

Waterproof Socket



Work Zone
Unibody design

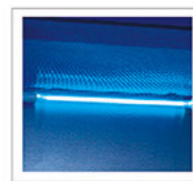

UV Lamp
Emission of 253.7 nanometers for most efficient decontamination.

ADVANTAGE

1. Large LCD display, all information displayed.
2. Automatic air speed adjustable with filter block.
3. With memory function in case of power-failure.
4. Side & back wall is made up of single piece stainless steel.
5. Interlock function: UV lamp and front window; UV lamp and blower, LED lamp; Blower and front window.
6. Front 10° slanted to offer operator comfort while working for long time, reduce glare and maximize reach into the work area.

TECHNICAL PARAMETERS

Model	BSC-3FA2	BSC-4FA2
External Size(W*D*H)	1087*775*2265mm	1383*775*2295mm
Internal Size(W*D*H)	910*600*660mm	1210*600*660mm
Work Surface Height	750mm	
Max Opening	520mm (21")	550mm (22")
Tested Opening	Safety height 200mm (8")	
Airflow Volume	Inflow	348m ³ /h (205cfm)
	Downflow	65%: 649m ³ /h (382cfm)
	Exhaust	35%: 348m ³ /h (205cfm)
Airflow Volume	Inflow	462m ³ /h (272cfm)
	Downflow	65%: 863m ³ /h (507cfm)
	Exhaust	35%: 462m ³ /h (272cfm)
Front Window	Manual. Laminated toughened glass. Anti UV	
HEPA Filter	Two, 99.995% efficiency at 0.3µm, filter life indicator	
Filter Guard Type	Aluminum alloy frame	
Noise	EN 12469≤65dB	
Illumination	≥1000Lux	
Display	LCD Display	
Waterproof Socket	2, Total consumption: ≤500W	
Tap	Water tap*1, Gas tap*1	
Ground Resistance	≤ 0.10Ω	
Power Supply	AC230V, 50Hz	
Consumption	≤550W	≤650W
Alarm	Abnormal airflow velocity, Filter replacement, Front window at unsafe height, High filter pressure alarm	
AC Motor	One ECM motor, 230V acceptable, Speed adjustable, high efficiency and low power consumption	
Material	Working area: 304 stainless steel	
	Frame and decorative plate: cold-rolled steel with anti-bacteria powder coating	
UV Lamp	20W	30W
	Germicidal UV lamp, Emission of 253.7nanometers for most efficient decontamination, UV timer, UV life indicator	
LED lamp	10W*2	18W*2
Standard Accessory	LED lamp*2, UV lamp*1, Base stand, SS water tap*1, SS gas tap*1, Drain valve, Waterproof sockets*2, Stainless steel I.V. bar with 10 hooks, Remote control	
Optional Accessory	Armrest, Airflow tester, Formalin fumigation sterilizer, Infrared sterilizer Electric height adjustable base stand, Motorized front window	
Package Size (W*D*H)	1240*1060*1900mm	1540*1080*1900mm
Gross Weight	270kg	340kg



NSF Certified Class II A2 Biological Safety Cabinet



Display for BSC-2FA2-NA



Display for BSC-2FA2-GL

Color Touch Screen
Touch operation, real-time and clearer display of various values and appointment timing function.

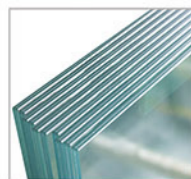

Front Window
Two-layer laminated toughened glass >6mm, Anti UV



Footmaster Caster
Universal caster with brake and leveling feet.



UV Lamp
Emission of 253.7 nanometers for most efficient decontamination.



SS Water Tap & Gas Tap



Waterproof Socket

ADVANTAGE

1. Motorized front window.
2. 7-inch large touch color display: touch operation, real-time and clearer display of various values of the safety cabinet, dynamic air flow pattern diagram, fault alarm sound and light prompt.
3. The power-on password can be set to prevent mis-operation by irrelevant personnel.
2. EC Fan, automatically adjust the wind speed.
3. With power-off memory function, the state before power-off will be restored after power-on and there will be visual prompts and alarms.
4. The integrated design of the operation area makes it easy to disassemble and clean.
5. The cabinet is separated from the base. The height of the adjustable base can be customized.
6. Interlocking function: UV lamp and front window; UV lamp and fan; fan and front window.
7. It has the function of appointment timing, which can automatically set the time of starting and shutting down the safety cabinet and the running time of ultraviolet lamps, fan and sockets.
8. The front window closes the trigger signal, so that the sterilization and disinfection function of the ultraviolet lamp is normally turned on.
9. The one-piece hand resting surface has a larger contact area with the arm and is more comfortable. air speed adjustable with filter block.

TECHNICAL PARAMETERS

Model	BSC-2FA2-NA BSC-2FA2-GL
External Size (W*D*H)	700*650*1920mm
Internal Size (W*D*H)	600*500*540mm
Work Surface Hight	750mm
Max Opening	370mm
Tested Opening	Safety height 254mm(10")
Inflow	290m³/h (170cfm)
Downflow	55%: 360m³/h (211cfm)
Exhaust	45%: 290m³/h (170cfm)
Front Window	Two-layer laminated toughened glass>6mm, Anti UV
ULPA Filter	≥99.9995% efficiency at 0.12μm
Filter Guard Type	Aluminum alloy frame
Noise	NSF 49≤67 dB
Illumination	≥1000Lux
Display	Capacitive touch screen
Waterproof Socket	Two, Total consumptions≤500W
Ground Resistance	≤0.1Ω
Power Supply	AC230V, 50/60Hz; AC115V, 60Hz, Full load Amps: 9A, BTU/Hr: 1689
Consumption	≤500W
Alarm	Abnormal airflow velocity; Filter replacement; Front window at unsafe height
Motor	One EC fan, 115V & 230V acceptable, Speed adjustable, High efficiency and low power consumption
Material	Working area: 304 stainless steel Frame and Decorative Plate: cold-rolled steel with anti-bacteria power coating
UV Lamp	15W
LED Lamp	10W*2
Standard Accessory	LED Lamp*2, UV lamp, Base stand, Drain valve, Waterproof sockets
Optional Accessory	Armrest, Airflow tester, Formalin fumigation sterilizer, Infrared sterilizer, Remote control, SS water tap*1& gas tap*1
Net Weight	150kg
Package Size (W*D*H)	Carton: 800*850*1350mm
Gross Weight	170kg



NSF Certified Class II A2 Biological Safety Cabinet



LCD display for BSC-4FA2, BSC-4FA2-GL and BSC-6FA2-GL



LCD display for BSC-4FA2-NA and BSC-6FA2-NA

LCD Display

Large LCD display is easy to monitor all the safety parameters at a glance; and ergonomically sized control panel improves users interface.

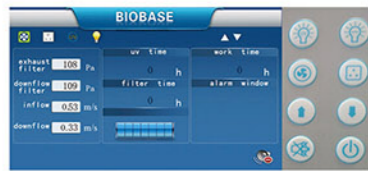

LCD display for BSC-3FA2-GL

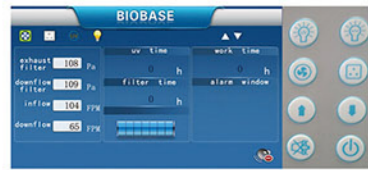

LCD display for BSC-3FA2-NA



Exhaust Thimble canopy(Optional)

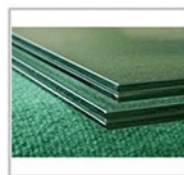

Front Window

Two-layer laminated toughened glass >6mm, Anti UV



Footmaster Caster

Universal caster with brake and leveling feet.

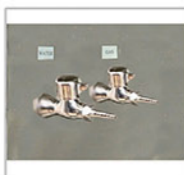

SS Water Tap & Gas Tap



Waterproof Socket

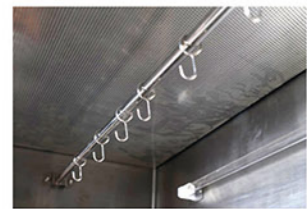

Stainless Steel I.V. Bar with 10 hooks



Work Zone

Unibody design

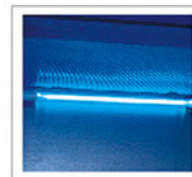

UV Lamp

Emission of 253.7 nanometers for most efficient decontamination.

ADVANTAGE

1. Motorized front window.
2. Large LCD display, all information displayed.
3. Automatic air speed adjustable with filter block.
4. With memory function in case of power-failure.
5. Side & back wall is made up of single piece stainless steel.
6. Interlock function: UV lamp and front window; UV lamp and blower, fluorescent lamp; Blower and front window.
7. Front 10° slanted to offer operator comfort while working for long time, reduce glare and maximize reach into the work area.

TECHNICAL PARAMETERS

Model	BSC-4FA2	BSC-3FA2-GL BSC-3FA2-NA	BSC-4FA2-GL BSC-4FA2-NA	BSC-6FA2-GL BSC-6FA2-NA
External Size(W*D*H)	1383*775*2295mm	1087*775*2265 mm	1383*775*2295mm	1873*775*2295mm
Internal Size(W*D*H)	1210*600*660 mm	910*600*660 mm	1210*600*660 mm	1700*600*660 mm
Work Surface Height	750mm with optional base stand			
Max Opening	550mm (22")	520mm(20.5")	550mm (22")	550mm (22")
Tested Opening	Safety height 200mm (8")		Safety height 254mm (10")	
Airflow Volume	Inflow	462m³/h (272cfm)	445m³/h(259cfm)	587m³/h(346cfm)
	Downflow	65%: 863m³/h (507cfm)	60%: 649m³/h(382cfm)	60%: 863m³/h(507cfm)
	Exhaust	35%: 462m³/h (272cfm)	40%:445m³/h(259cfm)	40%: 587m³/h(346cfm)
Front Window	Motorized. Two-layer laminated toughened glass ≥6mm. Anti UV.			
HEPA Filter	Two, 99.995% efficiency at 0.3µm, filter life indicator.			
Filter Guard Type	Aluminum alloy frame, glass fiber filter paper			
Noise	NSF 49≤67dB			
Illumination	≥1000Lux			
Display	LCD Display			
Waterproof Socket	Two, Total consumption: ≤500W			
Tap	Water tap*1, Gas tap *1			
Ground Resistance	≤ 0.10Ω			
Power Supply	AC230V, 50/60Hz; AC115V, 60Hz, Full load Amps: 9A, BTU/Hr: 1689			
Consumption	500W	400W	500W	700W
Alarm	Abnormal airflow velocity; Filter replacement; Front window at unsafe height; High filter pressure alarm			
DC Motor	One ECM motor, 115V& 230V acceptable, Speed adjustable, high efficiency and low power consumption			
Material	Working area: 304stainless steel Frame and Decorative Plate: cold-rolled steel with anti-bacteria power coating			
UV Lamp	30W	20W	30W	40W
	Germicidal UV lamp, Emission of 253.7 nanometers for most efficient decontamination			
Illuminating Lamp	18W*2	10W*2	18W*2	22W*2
	LED lamp			
Standard Accessory	LED lamp*2, UV lamp*1, Base stand, SS water tap*1, SS gas tap*1, Drain valve, Waterproof sockets*2, Stainless Steel IV Bar with 10 hooks,Remote control			
Optional Accessory	Armrest, Airflow tester, Formalin fumigation sterilizer,Infrared sterilizer, Electric height adjustable base stand			
Package Size (W*D*H)	1540*1080*1900mm	1240*1060*1900mm	1540*1080*1900mm	2020*1080*1900mm
Gross Weight	340kg	270kg	340kg	370kg



Basic Series Class II A2 Biological Safety Cabinet



Button Screen
Large LCD display is easy to monitor all the safety parameters at a glance; and ergonomically sized control panel improves users interface.



Work Zone
Work zone is made of 304 stainless steel, is surrounded by negative pressure.



Remote Control
All functions can be realized with it, making the operation much easier and convenient.



Waterproof Socket
2 waterproof sockets are located in the side panel, for optimum convenience of using small devices inside the cabinet.

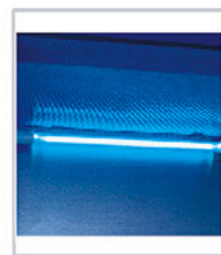

UV Lamp
Emission of 253.7 nanometers for most efficient decontamination.

ADVANTAGE

1. Small dimension, save space.
2. Centrifugal fan, speed adjustable; H14 HEPA filter.
3. Motorized front window: The front window is motorized for convenient, one-hand operation.
4. Audio and visual alarm: Abnormal airflow velocity, Filter replacement, Front window at unsafe height, High filter pressure alarm.
5. Time reserve function: This can save 30 minutes waiting time after activating the cabinet and the sterilization time after experiment.
6. Remote control: Each function can be realized 6 meters away from the cabinet by remote control, which can protect the operator under emergency.
7. Large LCD display: Operators can check detailed status of the cabinet, such as inflow and downflow velocity, work area temperature and humidity, filter pressure, UV working time and filter working time, filter life indicator etc.
8. With memory function in case of power-failure.
9. Interlock function: UV lamp and front window; UV lamp and blower, LED lamp; blower and front window.

TECHNICAL PARAMETERS

Model	11231 BBC 86
External Size(W*D*H)	700*650*1230mm(without base stand)
Internal Size(W*D*H)	600*500*540mm
Tested Opening	Safety height 200mm(8")
Max Opening	370mm(15")
Inflow Velocity	0.53±0.025m/s
Down Flow Velocity	0.33±0.025m/s
HEPA Filter	Two, 99.995% efficiency at 0.3µm. Filter life indicator
Front Window	Motorized. Single Layer toughened glass 5mm. Anti UV.
Noise	≤ 67dB
UV Lamp	15W*2 UV timer, UV life indicator, emission of 253.7 nanometers for most efficient decontamination
LED Lamp	8W*2
Illumination	≥1000Lux
Consumption	700W
Socket	Two, total load of two sockets: 500W
Display	LCD display
Control System	Microprocessor
Airflow System	70% air recirculation, 30% air exhaust
Visual and Audio Alarm	Filter replacement, window over height, abnormal air flow velocity; High filter pressure alarm.
Material	Work Zone: 304 stainless steel. Main Body: Cold-rolled steel with anti-bacteria powder coating
Work Surface Height	750mm with optional base stand
Power Supply	AC220V±10%, 50/60Hz; 110V±10%, 60Hz
Standard Accessory	LED lamp*2, UV lamp*2, Remote control, Waterproof sockets*2, Base stand
Optional Accessory	SS Water tap*1, SS Gas tap*1
Packing Size (without base stand)	Carton: 730*787*1450mm Wood: 860*780*1420mm
Gross Weight (without base stand)	Carton: 120kg Wood: 140kg
Package Size(with base stand)	Carton: 850*787*1450mm Wood: 860*970*1420mm
Gross Weight (with base stand)	Carton: 140kg Wood: 160kg

AC Series Class II A2 Biological Safety Cabinet



Color Screen
Real-time and clearer display of various values and appointment timing function.



Footmaster Caster
Universal caster with brake and leveling feet.



Cabinet Support Block
Easy to lift, prevent hand pressing



Iron hook support rod for panel support



UV Lamp
Emission of 253.7 nanometers for most efficient decontamination.

ADVANTAGE

1. Color key display: large screen, more clear and dynamic display of various values of the safety cabinet, and has the function of appointment timing.
2. Automatically adjust the wind speed.
3. With power-off memory function, the state before power-off will be restored after power-on, and there will be visual prompts and alarms.
4. The integrated design of the operation area makes it easy to disassemble and clean.
5. The cabinet is separated from the base. The height of the adjustable base can be customized.
6. Interlocking function: UV lamp and front window; UV lamp and fan, lamp; fan and front window.
7. It has the function of appointment timing, which can automatically set the time of starting and shutting down the safety cabinet and the running time of ultraviolet lamps, fans and sockets.
8. The front window closes the double trigger signal, so that the sterilization and disinfection function of the ultraviolet lamp is normally turned on.
9. The negative pressure air duct is equipped with a foreign matter filtering structure to prevent foreign matter such as paper scraps from entering the fan system and affecting the normal operation of the product.
10. The front window glass has a one-key lift function
11. The one-piece hand resting surface has a larger contact area with the arm and is more comfortable.

TECHNICAL PARAMETERS

Model	BSC-700 II A2-Z
External Size (W*D*H)	700*650*1920mm (700*650*1280mm without base stand)
Internal Size (W*D*H)	600*500*540mm
Tested Opening	Safety height 200mm
Max Opening	350mm
Inflow Velocity	0.53±0.025m/s
Down Flow Velocity	0.33±0.025m/s
ULPA Filter	Two, 99.9995% efficiency at 0.12µm, filter life indicator
Front Window	Motorized. Single Layer toughened glass 5mm. Anti UV.
Noise	≤65 dB
UV Lamp	15W*1 UV timer, UV life indicator, emission of 253.7 nanometers for most efficient decontamination
LED Lamp	8W*2
Illumination	≥1000Lux
Consumption	≤500W
Socket	Two, total load of two sockets: 500W
Display	LCD display: exhaust filter and downflow filter pressure, filter and UV lamp working time, inflow and downflow velocity, filter life, humidity and temperature, system working time etc.
Control System	70% air recirculation, 30% air exhaust
Visual and Audio Alarm	Filter replacement, window over height, abnormal air flow velocity; High filter pressure alarm, abnormal power failure
Material	Work Zone: 304 stainless steel Main Body: Cold-rolled steel with anti-bacteria powder coating
Work Surface Height	750mm with base stand
Power Supply	AC220V 50/60Hz; 110V 60Hz
Standard Accessory	Cabinet*1, Base stand*1, LED Lamp*2, UV lamp*1, Remote control, Drain valve*1, Waterproof Socket*2
Optional Accessory	Water and gas tap, Electric height adjustable base stand, Armrest
Package Size(W*D*H)	880*787*1500mm (760*787*1500mm without base stand)
Gross Weight	165kg (145kg without base stand)



AC Series Class II A2 Biological Safety Cabinet



Color Screen

Real-time and clearer display of various values and appointment timing function.



Footmaster Caster

Universal caster with brake and leveling feet.



Cabinet Support Block

Easy to lift, prevent hand pressing



Iron hook support rod for panel support



UV Lamp

Emission of 253.7 nanometers for most efficient decontamination.

ADVANTAGE

1. Color key display: large screen, more clear and dynamic display of various values of the safety cabinet, and has the function of appointment timing.
2. Automatically adjust the wind speed.
3. With power-off memory function, the state before power-off will be restored after power-on, and there will be visual prompts and alarms.
4. The integrated design of the operation area makes it easy to disassemble and clean.
5. The cabinet is separated from the base. The height of the adjustable base can be customized.
6. Interlocking function: UV lamp and front window; UV lamp and fan, lamp; fan and front window.
7. It has the function of appointment timing, which can automatically set the time of starting and shutting down the safety cabinet and the running time of ultraviolet lamps, fans and sockets.
8. The front window closes the double trigger signal, so that the sterilization and disinfection function of the ultraviolet lamp is normally turned on.
9. The negative pressure air duct is equipped with a foreign matter filtering structure to prevent foreign matter such as paper scraps from entering the fan system and affecting the normal operation of the product.
10. The front window glass has a one-key lift function
11. The cabinet is designed with a 10° inclination angle, which is in line with ergonomic principles, with a larger viewing angle, convenient operation and more humanization.
12. The one-piece hand rest has a large flat surface, which has a larger contact area with the arm and is more comfortable.

TECHNICAL PARAMETERS

Model	BSC-1100 II A2-X	BSC-1300 II A2-X	BSC-1500 II A2-X	BSC-1800 II A2-X	BSC-2000 II A2-X
External Size (W*D*H)	1100*755*2200mm	1300*755*2200mm	1500*755*2200mm	1800*755*2200mm	1950*800*2170mm
Internal Size (W*D*H)	940*600*660mm	1150*600*660mm	1350*600*660mm	1625*600*660mm	1800*600*660mm
Tested Opening	Safety height 200mm (8")				
Max Opening	440mm				
Inflow Velocity	0.53±0.025m/s				
Downflow Velocity	0.33±0.025m/s				
ULPA Filter	Two, 99.9995% efficiency at0.12µm, filter life indicator				
Front Window	Motorized. Two-layer laminated toughened glass≥6mm. Anti UV				
Noise	≤65dB				
UV Lamp	30W*1	30W*1	40W*1	40W*1	40W*1
	UV timer, UV life indicator, emission of 235.7 nanometers for most efficient decontamination				
LED Lamp	12W*2	14W*2	16W*2	16W*2	12W*4
Illumination	≥1000Lux				
Consumption	600W	800W	1300W	1300W	1700W
Waterproof Socket	Two, total load of two sockets: 500W				
Display	LCD display: exhaust filter and downflow filter pressure, filter and UV lamp working time, inflow and downflow velocity, filter life, humidity and temperature, system working time etc.				
Control System	Microprocessor				
Airflow System	70% air recirculation. 30% air exhaust				
Visual and Audio Alarm	Abnormal airflow velocity, filter replacement, front window at unsafe height, high filter pressure alarm, abnormal power failure				
Material	Work Zone: 304 stainless steel Main Body: Cold-rolled steel with anti-bacteria powder coating				
Work Surface Height	750mm (Size can be customized according to requirements)				
Caster	Footmaster caster				
Power Supply	AC220V 50 / 60Hz; 110V 60Hz				
Standard Accessory	LED lamp 2pcs, UV lamp 1pc, Base stand, Remote control, Foot switch, Drain valve, Waterproof socket 2pcs				
Optional Accessory	Water and gas tap, Electric height adjustable base stand, Armrest				
Gross Weight	220kg	280kg	316kg	366kg	420kg
Package Size (W*D*H)	1230*1060*1840mm	1430*1060*1840mm	1630*1060*1840mm	1930*1060*1840mm	2080*1060*1840mm



Pro Series Class II A2 Biological Safety Cabinet



LCD Display

7 inch large touch screen is easy to monitor all the safety parameters at a glance and ergonomically sized control panel



Handle

Four handles on each corner, easier to move the unit to anywhere



Work Zone

Work zone is made of 304 stainless steel, is surrounded by negative pressure.



Remote Control

All functions can be realized with it, making the operation much easier and convenient.



Waterproof Socket

2 waterproof sockets are located in the side panel, for optimum convenience of using small devices inside the cabinet.

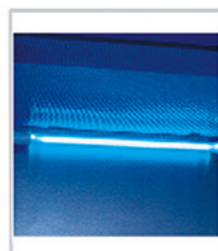

UV Lamp

Emission of 253.7 nanometers for most efficient decontamination.

ADVANTAGE

1. Small dimension, save space.
2. Centrifugal fan, speed adjustable; H14 HEPA filter.
3. Motorized front window: The front window is motorized for convenient, one-hand operation.
4. Audio and visual alarm: Abnormal airflow velocity, Filter replacement, Front window at unsafe height, High filter pressure alarm.
5. Self-locking button switch to solve the trouble of losing the key.
6. Removable handle design, easy to move.
7. 7 inch Large touch screen with Intelligent control system: Operators can check detailed status of the cabinet, such as inflow and downflow velocity, work area temperature and humidity, filter pressure, UV working time and filter working time, filter life indicator etc.
8. With memory function in case of power-failure.
9. Interlock function: UV lamp and front window; UV lamp and blower, LED lamp; blower and front window.

TECHNICAL PARAMETERS

Model	11231 BBC 86-Pro
External Size(W*D*H)	700*650*1230mm
Internal Size(W*D*H)	600*500*540mm
Tested Opening	Safety height 200mm(8")
Max Opening	370mm(15")
Inflow Velocity	0.53±0.025m/s
Down Flow Velocity	0.33±0.025m/s
HEPA Filter	Two, 99.995% efficiency at 0.3µm. Filter life indicator
Front Window	Motorized. Single Layer toughened glass≥5mm. Anti UV.
Noise	≤ 67dB
UV Lamp	15W*2 UV timer, UV life indicator, emission of 253.7 nanometers for most efficient decontamination
LED Lamp	8W*2
Illumination	≥1000Lux
Consumption	500W
Socket	Two, total load of two sockets: 500W
Display	7 inch large touch screen
Control System	Microprocessor
Airflow System	70% air recirculation, 30% air exhaust
Visual and Audio Alarm	Filter replacement, window over height, abnormal air flow velocity; High filter pressure alarm.
Material	Work Zone: 304 stainless steel. Main Body: Cold-rolled steel with anti-bacteria powder coating
Work Surface Height	750mm with optional base stand
Power Supply	AC220V±10%, 50/60Hz; 110V±10%, 60Hz
Standard Accessory	LED lamp*2, UV lamp*2, Remote control, Waterproof sockets*2, base stand, handle*4, universal caster with brake and leveling feet
Optional Accessory	SS Water tap*1, SS Gas tap*1
Packing Size (without base stand)	Carton: 730*787*1450mm Wood: 860*780*1420mm
Gross Weight (without base stand)	Carton: 120kg Wood: 140kg
Packing Size (with base stand)	Carton: 850*787*1450mm Wood: 860*970*1420mm
Gross Weight (with base stand)	Carton: 140kg Wood: 160kg



Pro Series Class II A2 Biological Safety Cabinet



LCD Display
7 Inch touch screen display is easy to monitor all the safety parameters at a glance and ergonomically sized control panel improves user interface.



Remote Control
All functions can be realized with it, making the operation much easier and more convenient.



Work Zone
Work zone, made of 304 stainless steel, is surrounded by negative pressure.

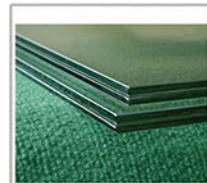

Front Window
Two-layer laminated toughened glass >6mm, Anti UV

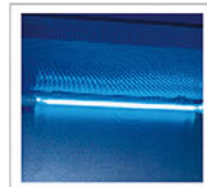

UV Lamp
Emission of 253.7 nanometers for most efficient decontamination.



Air-Vent



Footmaster Caster
Universal caster with brake and leveling feet.



Foot Switch
Adjust front window height by foot during experiment, to avoid airflow turbulence caused by arm movement.



Waterproof Socket
2 waterproof sockets are located in the side wall, for optimum convenience of using small devices inside the cabinet.

ADVANTAGE

1. The operation perspective is wide and more humanized.
2. Time reserve function.
3. ULPA filter life and UV life indicator.
4. Motorized front window.
5. With memory function in case of power-failure.
6. Audio and visual alarm (Abnormal airflow velocity; Filter replacement; Front window at unsafe height; High filter pressure alarm).
7. Self-locking button switch to solve the trouble of losing the key.
8. 7 inch Large touch screen with Intelligent control system: Operators can check detailed status of the cabinet, such as inflow and downflow velocity, work area temperature and humidity, filter pressure, UV working time and filter working time, filter life indicator etc.
9. Remote control: all functions can be realized with it, making the operation much easier and more convenient.
10. Interlock function: UV lamp and front window; UV lamp and blower, LED lamp; blower and front window.
11. Foot switch: adjust front window height by foot during experiment, to avoid airflow turbulence caused by arm movement.

TECHNICAL PARAMETERS

Model	BSC-1100IIA2-Pro	BSC-1300IIA2-Pro	BSC-1800IIA2-Pro
External Size(W*D*H)	1100*750*2210mm	1383*750*2310mm	1873*780*2310mm
Internal Size(W*D*H)	940*600*660mm	1210*600*660mm	1700*600*660mm
Tested Opening	Safety Height 200mm(8")		
Max Opening	420mm(17")	500mm (20")	520mm(21")
Inflow Velocity	0.53±0.025 m/s		
Downflow Velocity	0.33±0.025 m/s		
ULPA Filter	Two, 99.9995% efficiency at 0.12µm. Filter life indicator.		
Front Window	Motorized. Two-layer laminated toughened glass ≥ 6mm. Anti UV.		
Noise	≤ 67dB		
UV Lamp	30W*2	30W*2	40W*2
	UV timer, UV life indicator, emission of 253.7 nanometers for most efficient decontamination.		
Illuminating Lamp	LED lamp		
	12W*2	12W*2	16W*2
Illumination	≥1000Lux		
Consumption	600W	1300W	1300W
Waterproof Sockets	Two, total load of two sockets: 500W		
Display	7 inch touch sren display: exhaust filter and downflow filter pressure, filter and UV lamp working time, inflow and downflow velocity, filter life, humidity and temperature, system working time etc.		
Control System	Microprocessor		
Airflow System	70% air recirculation, 30% air exhaust		
Visual and audio alarm	Abnormal airflow velocity, Filter replacement, Front window at unsafe height, High filter pressure alarm.		
Material	Work Zone: 304 stainless steel Main Body: Cold-rolled steel with anti-bacteria powder coating.		
Work Surface Height	750mm(Size can be customized according to requirements)		
Caster	Footmaster caster		
Power Supply	AC220V±10%, 50/60Hz; 110V±10%, 60Hz		
Standard Accessory	LED lamp*2, UV lamp*2, Base stand, Remote control, Foot switch, Drain valve, Waterproof sockets*2		
Optional Accessory	Water and gas tap, Electric height adjustable base stand, Armrest, chair		
Gross Weight	265kg	340kg	430kg
Package Size(W*D*H)	1250*990*1770mm	1540*1080*1910mm	2000*1075*1910mm



EC Series Class II A2 Biological Safety Cabinet



Color Touch Screen
Touch operation, real-time and clearer display of various values and appointment timing function.



Wind Speed Sensor & EC Fan



Stepper Motor and Handle
The front window can be controlled manually or electrically



Iron hook support rod for panel support



Footmaster Caster
Universal caster with brake and leveling feet.



Cabinet Support Block
Easy to lift, prevent hand pressing



UV Lamp
Emission of 253.7 nanometers for most efficient decontamination.

ADVANTAGE

- 7-inch touch color display screen: touch operation, real-time more clear and dynamic display of various values of the safety cabinet, and has the function of appointment timing.
- Power-on password can be set to prevent unrelated personnel from mis-operation.
- Automatically adjust the wind speed.
- With power-off memory function, the state before power-off is restored after power-on, and there is a visual prompt alarm.
- The integrated design of the operation area makes it easy to disassemble and clean.
- The working area is equipped with a wind speed sensor to detect the wind speed in real and real time.
- It can be used manually or electrically, and the front window can be closed by pulling down the glass door when the power is off.
- The cabinet is separated from the base. The height of the adjustable base can be customized.
- Interlocking function: UV lamp and front window; UV lamp and fan, fluorescent lamp; fan and front window.
- It has the function of appointment timing, which can automatically set the time of starting and shutting down the safety cabinet and the running time of ultraviolet lamps, fans and sockets.
- The front window closes the double trigger signal, so that the sterilization and disinfection function of the ultraviolet lamp is normally turned on.
- The negative pressure air duct is equipped with a foreign matter filtering structure to prevent foreign matter such as paper scraps from entering the fan system and affecting the normal operation of the product.
- The front window glass has a one-key lift function.

TECHNICAL PARAMETERS

Model	EA2-2F
External Size (W*D*H)	700*700*2000mm
Internal Size (W*D*H)	600*500*540mm
Tested Opening	Safety height 200mm
Max Opening	350mm
Inflow Velocity	0.53±0.025m/s
Downflow Velocity	0.33±0.025m/s
ULPA Filter	Two, 99.9995% efficiency at 0.12µm, filter life indicator
Front Window	Manual and electric. Tempered glass≥5mm. Anti UV
Noise	≤65 dB
UV Lamp	15W*1 UV timer, UV life indicator, emission of 235.7 nanometers for most efficient decontamination
LED Lamp	8W*2
Illumination	≥1000Lux
Consumption	≤500W
Waterproof Socket	Two, total load of two sockets: 500W
Display	LCD display: exhaust filter and downflow filter pressure, filter and UV lamp working time, inflow and downflow velocity, filter life, humidity and temperature, system working time etc.
Control System	70% air recirculation, 30% air exhaust
Visual and Audio Alarm	Filter replacement, window over height, abnormal air flow velocity, high filter pressure, abnormal power failure
Material	Work Zone: 304 stainless steel Main Body: Cold-rolled steel with anti-bacteria powder coating
Work Surface Height	750mm with base stand
Power Supply	AC220V 50/60Hz; 110V 60Hz
Standard Accessory	Cabinet*1, Base stand*1, LED lamp*2, UV lamp*1, Drain ball valve*1, Waterproof Socket*2, EC Fan
Optional Accessory	Water and gas tap, Electric height adjustable base stand, Armrest
Package Size (W*D*H)	800*880*1500mm
Gross Weight	170kg



EC Series Class II A2 Biological Safety Cabinet



Color Touch Screen
Touch operation, real-time and clearer display of various values and appointment timing function.



Wind Speed Sensor & EC Fan



Stepper Motor and Handle
The front window can be controlled manually or electrically



Iron hook support rod for panel support



Footmaster Caster
Universal caster with brake and leveling feet.



Cabinet Support Block
Easy to lift, prevent hand pressing



UV Lamp
Emission of 253.7 nanometers for most efficient decontamination.

ADVANTAGE

- 7-inch touch color display screen: touch operation, real-time more clear and dynamic display of various values of the safety cabinet, and has the function of appointment timing.
- The power-on password can be set to prevent unrelated personnel from mis-operation.
- Automatically adjust the wind speed.
- With power-off memory function, the state before power-off will be restored after power-on, and there will be visual prompts and alarms.
- The integrated design of the operation area makes it easy to disassemble and clean.
- The working area is equipped with a wind speed sensor to detect the wind speed in real and real time.
- It can be used manually or electrically, and the front window can be closed by pulling down the glass door when the power is off.
- The cabinet is separated from the base. The height of the adjustable base can be customized.
- Interlocking function: UV lamp and front window; UV lamp and fan, fluorescent lamp; fan and front window.
- It has the function of appointment timing, which can automatically set the time of starting and shutting down the safety cabinet and the running time of ultraviolet lamps, fans and sockets.
- The front window closes the double trigger signal, so that the sterilization and disinfection function of the ultraviolet lamp is normally turned on.
- The negative pressure air duct is equipped with a foreign matter filtering structure to prevent foreign matter such as paper scraps from entering the fan system and affecting the normal operation of the product.
- The front window glass has a one-key lift function
- The cabinet is designed with a 10° inclination angle, which is in line with ergonomic principles, has a larger viewing angle, is easy to operate and is more user-friendly.

TECHNICAL PARAMETERS

Model	EA2-3F	EA2-4F	EA2-5F	EA2-6F
External Size (W*D*H)	1100*800*2200mm	1300*800*2200mm	1500*800*2200mm	1800*800*2200mm
Internal Size (W*D*H)	940*600*660mm	1150*600*660mm	1350*600*660mm	1625*600*660mm
Tested Opening	Safety height 200mm (8")			
Max Opening	440mm			
Inflow Velocity	0.53±0.025m/s			
Downflow Velocity	0.33±0.025m/s			
ULPA Filter	Two, 99.9995% efficiency at 0.12µm, filter life indicator			
Front Window	Manual and electric. Tempered glass≥5mm. Anti UV			
Noise	≤65 dB			
UV Lamp	30W*1	30W*1	40W*1	40W*1
	UV timer, UV life indicator, emission of 235.7 nanometers for most efficient decontamination			
LED Lamp	12W*2	14W*2	16W*2	16W*2
Illumination	≥1000Lux			
Consumption	600W	800W	1300W	1300W
Waterproof Socket	Two, total load of two sockets: 500W			
Display	LCD display: exhaust filter and downflow filter pressure, filter and UV lamp working time, inflow and downflow velocity, filter life, humidity and temperature, system working time etc.			
Control System	Microprocessor			
Airflow System	70% air recirculation, 30% air exhaust			
Visual and Audio Alarm	Filter replacement, window over height, abnormal air flow velocity, high filter pressure, abnormal power failure			
Material	Work Zone: 304 stainless steel Main Body: Cold-rolled steel with anti-bacteria powder coating			
Work Surface Height	750mm (Size can be customized according to the requirements)			
Caster	Footmaster caster			
Power Supply	AC220V 50/60Hz; 110V 60Hz			
Standard Accessory	LED lamp 2pcs, UV lamp 1pc, Base stand, Foot switch, Drain valve, Waterproof sockets 2pcs, EC Fan			
Optional Accessory	Water and gas tap, Electric height adjustable base stand, Armrest			
Gross Weight	258kg	291kg	333kg	408kg
Package Size (W*D*H)	1230*1060*1840mm	1430*1060*1840mm	1630*1060*1840mm	1930*1060*1840mm

Class II B2 Biological Safety Cabinet

Three protection: operator, sample and environment.

Airflow system: 0% air recirculation, 100% air exhaust.

A Class II B2 BSC, also called a total exhaust cabinet, is necessary when significant amounts of radionuclides and volatile chemicals are expected to be used.

Class II B2 Biological Safety Cabinet

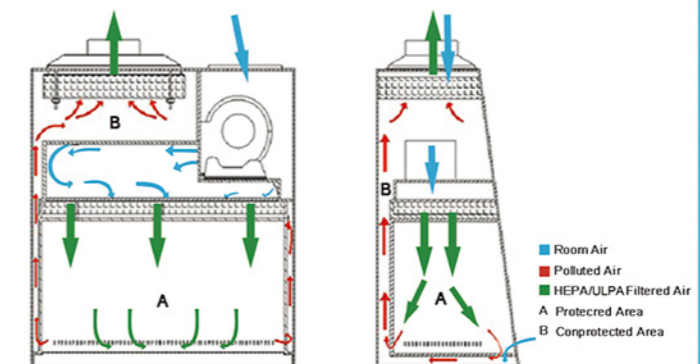



NSF Certified Class II B2 Biological Safety Cabinet



LCD Display for BSC-4FB2-NA



LCD Display for BSC-4FB2-GL



Work Zone

Work zone, made of 304 stainless steel, is surrounded by negative pressure.



Remote Control

All functions can be realized with it, making the operation much easier and more convenient.



Footmaster Caster

Universal caster with brake and leveling feet

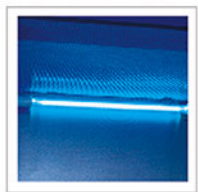

UV Lamp

Emission of 253.7 nanometers for most efficient decontamination.

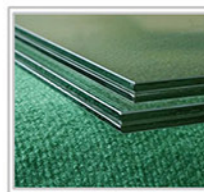

Front Window

Two-layer laminated toughened glass >5mm, anti UV



Waterproof Socket

2 waterproof sockets are located in the side wall, for optimum convenience of using small devices inside the cabinet.

ADVANTAGE

1. Motorized front window.
2. HEPA filter life and UV life indicator.
3. Automatic air speed adjustable with filter block.
4. With memory function in case of power-failure.
5. Work area surrounded by negative pressure, it can ensure maximum safety in work area.
6. Most accessories are standard, which saves your money. There is no need to pay more.
7. Audio and visual alarm (filter replacement, window over height, abnormal air flow velocity, etc).
8. Remote control. All functions can be realized with it, making the operation much easier and more convenient.
9. Interlock function: UV lamp and front window; UV lamp and blower, fluorescent lamp; blower and front window.

TECHNICAL PARAMETERS

Model	BSC-4FB2-NA	BSC-4FB2-GL
External Size(W*D*H)	1383*775*2330mm	
Internal Size(W*D*H)	1210*600*660 mm	
Tested Opening	Safety height 200mm (8")	
Max Opening	550mm(22")	
Exhaust Airflow Volume	100%: 1320m³/h(776cfm)	
Front Window	Motorized. Two-layer laminated toughened glass ≥5mm. Anti UV	
HEPA Filter	Two, 99.999% efficiency at 0.3um, filter life indicator	
Filter Guard Type	Aluminum alloy frame	
Noise	NSF 49≤67 dB/EN 12469≤65dB	
Illumination	≥1000Lux	
Display	LCD Display	
Waterproof Socket	2, Total consumption: ≤500W	
Tap	Water tap*1, Gas tap *1	
Ground Resistance	≤ 0.10Ω	
Power Supply	AC230V, 50Hz; 115V, 60Hz, Full load Amps: 9A, BTU/Hr: 1689	
Consumption	400w	
Alarm	Abnormal airflow velocity; Filter replacement; Front window at unsafe height.	
DC Motor	One ECM motor, 115V& 230V acceptable, Speed adjustable, high efficiency and low power consumption	
Material	Working area: 304stainless steel Frame and Decorative Plate: cold-rolled steel with anti-bacteria power coating	
UV Lamp	30W Germicidal UV lamp, Emission of 253.7 nanometers for most efficient decontamination	
Illuminating Lamp	18W*2 LED lamp	
Standard Accessory	LED lamp*2, UV lamp*1, Base stand, SS water tap*1, SS gas tap*1, Drain valve, Waterproof sockets*2, Stainless Steel IV Bar with 10 hooks, Remote control	
Optional Accessory	Armrest, Airflow tester, Formalin fumigation sterilizer, Infrared sterilizer, Electric height adjustable base stand, exhaust duct	
Package Size (W*D*H)	1540*1080*1950mm	
Gross Weight	350kg	

Note: Customers need to prepare an external exhaust fan or exhaust system by themselves.



AC Series Class II B2 Biological Safety Cabinet



Color Screen
Real-time and clearer display of various values and appointment timing function.



Footmaster Caster
Universal caster with brake and leveling feet.



Cabinet Support Block
Easy to lift, prevent hand pressing



Iron hook support rod for panel support

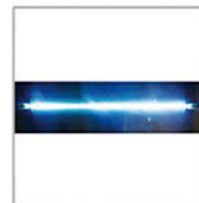

UV Lamp
Emission of 253.7 nanometers for most efficient decontamination.

ADVANTAGE

1. Color key display: large screen, more clear and dynamic display of various values of the safety cabinet, and has the function of appointment timing.
2. Automatically adjust the wind speed.
3. With power-off memory function, the state before power-off will be restored after power-on, and there will be visual prompts and alarms.
4. The integrated design of the operation area makes it easy to disassemble and clean.
5. The cabinet is separated from the base. The height of the adjustable base can be customized.
6. Interlocking function: UV lamp and front window; UV lamp and fan, lamp; fan and front window.
7. It has the function of appointment timing, which can automatically set the time of starting and shutting down the safety cabinet and the running time of ultraviolet lamps, fans and sockets.
8. The front window closes the double trigger signal, so that the sterilization and disinfection function of the ultraviolet lamp is normally turned on.
9. The negative pressure air duct is equipped with a foreign matter filtering structure to prevent foreign matter such as paper scraps from entering the fan system and affecting the normal operation of the product.
10. The front window glass has a one-key lift function
11. The cabinet is designed with a 10° inclination angle, which is in line with ergonomic principles, with a larger viewing angle, convenient operation and more humanization.
12. The one-piece hand rest has a large flat surface, which has a larger contact area with the arm and is more comfortable.

TECHNICAL PARAMETERS

Model	BSC-1100 II B2-X	BSC-1300 II B2-X	BSC-1500 II B2-X	BSC-1800 II B2-X
External Size (W*D*H)	1100*775*2250mm	1300*775*2250mm	1500*775*2250mm	1800*775*2250mm
Internal Size (W*D*H)	940*600*660mm	1150*600*660mm	1350*600*660mm	1625*600*660mm
Tested Opening	Safety height 200mm (8")			
Max Opening	440mm			
Inflow Velocity	0.53±0.025m/s			
Downflow Velocity	0.33±0.025m/s			
ULPA Filter	Two, 99.9995% efficiency at 0.12µm, filter life indicator			
Front Window	Motorized. Two-layer laminated toughened glass≥6mm. Anti UV			
Noise	≤65 dB			
UV Lamp	30W*1	30W*1	40W*1	40W*1
	UV timer, UV life indicator, emission of 235.7 nanometers for most efficient decontamination			
LED Lamp	12W*2	14W*2	16W*2	16W*2
Illumination	≥1000Lux			
Consumption	1300W	1300W	1300W	1300W
Waterproof Socket	Two, total load of two sockets: 500W			
Display	LCD display: exhaust filter and downflow filter pressure, filter and UV lamp working time, inflow and downflow velocity, filter life, humidity and temperature, system working time etc.			
Control System	Microprocessor			
Airflow System	0% air recirculation. 100% air exhaust			
Visual and Audio Alarm	Abnormal airflow velocity, Filter replacement, Front window at unsafe height, High filter pressure alarm, abnormal power failure			
Material	Work Zone: 304 stainless steel Main Body: Cold-rolled steel with anti-bacteria powder coating			
Work Surface Height	750mm (Size can be customized according to requirements)			
Caster	Footmaster caster			
Power Supply	AC220V 50 / 60Hz; 110V 60Hz			
Standard Accessory	LED lamp 2pcs, UV lamp 1pc, Base stand, Remote control, Foot switch, Drain valve, Waterproof socket 2pcs, Exhaust blower, Exhaust duct			
Optional Accessory	Water and gas tap, Electric height adjustable base stand, Armrest			
Gross Weight	243kg; 52kg	282kg; 64kg	300kg; 64kg	408kg; 64kg
Package (W*D*H)	1230*1060*1840mm 930*800*700mm	1430*1060*1840mm 930*860*740mm	1630*1060*1840mm 930*860*740mm	1930*1060*1840mm 930*860*740mm



Pro Series Class II B2 Biological Safety Cabinet

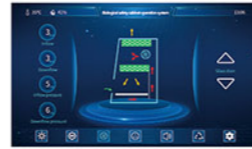

LCD Display
7 inch touch screen display is easy to monitor all the safety parameters at a glance and ergonomically sized control panel improves user interface.



Work Zone
Work zone, made of 304 stainless steel, is surrounded by negative pressure.



Remote Control
All functions can be realized with it, making the operation much easier and more convenient.

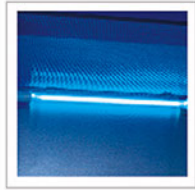

UV Lamp
Emission of 253.7 nanometers for most efficient decontamination.

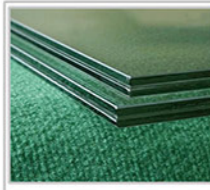

Front Window
Two-layer laminated toughened glass >6mm, Anti UV



Footmaster Caster
Universal caster with brake and leveling feet



Foot Switch
Adjust front window height by foot during experiment, to avoid airflow turbulence caused by arm movement.



Waterproof Socket
2 waterproof sockets are located in the side wall, for optimum convenience of using small devices inside the cabinet.

ADVANTAGE

1. Larger angle of view, easy to operate and more humanized.
2. Motorized front window.
3. ULPA filter life and UV life indicator.
4. Time reserve function.
5. With memory function in case of power-failure.
6. Self-locking button switch to solve the trouble of losing the key.
7. 7 inch Large touch screen with Intelligent control system: Operators can check detailed status of the cabinet, such as inflow and downflow velocity, work area temperature and humidity, filter pressure, UV working time and filter working time, filter life indicator etc.
8. Audio and visual alarm (filter replacement, window over height, abnormal air flow velocity, etc. High filter pressure alarm).
9. Remote control. All functions can be realized with it, making the operation much easier and more convenient.
10. Interlock function: UV lamp and front window; UV lamp and blower, fluorescent lamp; blower and front window
11. Foot switch. Adjust front window height by foot during experiment, to avoid airflow turbulence caused by arm movement.

TECHNICAL PARAMETERS

Model	BSC-1100IIB2-Pro	BSC-1500IIB2-Pro	BSC-1800IIB2-Pro
External Size (W*D*H)	1100*750*2255mm	1500*770*2290mm	1873*795*2280mm
Internal Size (W*D*H)	940*600*660mm	1350*600*660mm	1700*600*660mm
Tested Opening	Safety Height 200mm(8")		
Max Opening	420 mm (17")	500mm (20")	480mm (20")
Inflow Velocity	0.53±0.025m/s		
Downflow Velocity	0.33±0.025m/s		
ULPA Filter	Two, 99.9995% efficiency at 0.12µm, filter life indicator.		
Front Window	Motorized, two-layer laminated toughened glass ≥ 6mm, anti UV		
Noise	≤ 67dB		
UV Lamp	30W*2	40W*2	40W*2
	UV timer, UV life indicator, emission of 253.7 nanometers for most efficient decontamination.		
Illuminating Lamp	LED lamp		
	12W*2	16W*2	16W*2
Illumination	≥1000Lux		
Consumption	800W	1300W	1400W
Waterproof Sockets	Two, total load of two sockets: 500W		
Display	7 inch touch screen display: exhaust filter and downflow filter pressure, filter and UV lamp working time, inflow and downflow velocity, filter life, humidity and temperature, system working time etc.		
Control System	Microprocessor		
Airflow System	0% air re-circulation, 100% air exhaust		
Alarm	Abnormal airflow velocity; Filter replacement; Front window at unsafe height; High filter pressure alarm.		
Exhaust Duct	4 meters PVC duct, Diameter:300mm		
Material	Work Zone: 304 stainless steel Main Body: Cold-rolled steel with anti-bacteria powder coating		
Work Surface Height	750mm(Size can be customized according to requirements)		
Caster	Footmaster caster		
Power Supply	AC 220V±10%, 50/60Hz; 110V±10%, 60Hz (110V/60Hz is not applicable to BSC-1800IIB2-Pro)		
Standard Accessory	LED lamp*2, UV lamp*2, base stand, remote control, foot switch, exhaust blower, exhaust duct, drain valve, waterproof sockets*2, pipe strap*2		
Optional Accessory	Water and gas tap, Electric height adjustable base stand		
Gross Weight	265kg;50kg	325kg;56kg	420kg;60kg
Package	Main Body	1250*990*1770mm	1650*990*1820mm
	Exhaust Blower (W*D*H)	930*800*690mm	930*800*710mm
		2000*1075*1910mm	920*710*680mm

EC Series Class II B2 Biological Safety Cabinet



Color Touch Screen
Touch operation, real-time and clearer display of various values and appointment timing function.



Wind Speed Sensor & EC Fan



Stepper Motor and Handle
The front window can be controlled manually or electrically



Iron hook support rod for panel support



Footmaster Caster
Universal caster with brake and leveling feet.



Cabinet Support Block
Easy to lift, prevent hand pressing

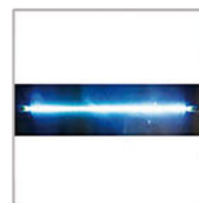

UV Lamp
Emission of 253.7 nanometers for most efficient decontamination.

ADVANTAGE

- 7-inch touch color display screen: touch operation, real-time more clear and dynamic display of various values of the safety cabinet, and has the function of appointment timing.
- The power-on password can be set to prevent unrelated personnel from mis-operation.
- Automatically adjust the wind speed.
- With power-off memory function, the state before power-off will be restored after power-on, and there will be visual prompts and alarms.
- The integrated design of the operation area makes it easy to disassemble and clean.
- The working area is equipped with a wind speed sensor to detect the wind speed in real and real time.
- It can be used manually or electrically, and the front window can be closed by pulling down the glass door when the power is off.
- The cabinet is separated from the base. The height of the adjustable base can be customized.
- Interlocking function: UV lamp and front window; UV lamp and fan, fluorescent lamp; fan and front window.
- It has the function of appointment timing, which can automatically set the time of starting and shutting down the safety cabinet and the running time of ultraviolet lamps, fans and sockets.
- The front window closes the double trigger signal, so that the sterilization and disinfection function of the ultraviolet lamp is normally turned on.
- The negative pressure air duct is equipped with a foreign matter filtering structure to prevent foreign matter such as paper scraps from entering the fan system and affecting the normal operation of the product.
- The front window glass has a one-key lift function
- The cabinet is designed with a 10° inclination angle, which is in line with ergonomic principles, has a larger viewing angle, is easy to operate and is more user-friendly.

TECHNICAL PARAMETERS

Model	EB2-3F	EB2-4F	EB2-5F	EB2-6F
External Size (W*D*H)	1100*800*2250mm	1300*800*2250mm	1500*800*2250mm	1800*800*2250mm
Internal Size (W*D*H)	940*600*660mm	1150*600*660mm	1350*600*660mm	1625*600*660mm
Tested Opening	Safety height 200mm (8")			
Max Opening	440mm			
Inflow Velocity	0.53±0.025m/s			
Downflow Velocity	0.33±0.025m/s			
ULPA Filter	Two, 99.9995% efficiency at 0.12µm, filter life indicator			
Front Window	Manual and electric. Tempered glass≥5mm. Anti UV			
Noise	≤65 dB			
UV Lamp	30W*1	30W*1	40W*1	40W*1
	UV timer, UV life indicator, emission of 235.7 nanometers for most efficient decontamination			
LED Lamp	12W*2	14W*2	16W*2	16W*2
Illumination	≥1000Lux			
Consumption	800W	850W	1300W	1300W
Waterproof Socket	Two, total load of two sockets: 500W			
Display	LCD display: exhaust filter and downflow filter pressure, filter and UV lamp working time, inflow and down flow velocity, filter life, humidity and temperature, system working time etc.			
Control System	Microprocessor			
Airflow System	0% air recirculation, 100% air exhaust			
Visual and Audio Alarm	Filter replacement, window over height, abnormal air flow velocity, high filter pressure, abnormal power failure			
Material	Work Zone: 304 stainless steel Main Body: Cold-rolled steel with anti-bacteria powder coating			
Work Surface Height	750mm (Size can be customized according to the requirements)			
Caster	Footmaster caster			
Power Supply	AC220V 50/60Hz; 110V 60Hz			
Standard Accessory	LED lamp 2pcs, UV lamp 1pcs, Base stand, Foot switch, Drain valve, Waterproof sockets 2pcs, EC Fan, Exhaust blower, Exhaust duct			
Optional Accessory	Water and gas tap, Electric height adjustable base stand, Armrest			
Gross Weight	259kg; 52kg	291kg; 64kg	310kg; 64kg	383kg; 64kg
Package Size	Main Body 1230*1060*1840mm Exhaust Blower (W*D*H) 930*800*700mm	1430*1060*1840mm 930*860*740mm	1630*1060*1840mm 930*860*740mm	1930*1060*1840mm 930*860*740mm

Cytotoxic Safety Cabinet

BIOBASE Cytotoxic Safety Cabinet is the premium solution for cytotoxic/antineoplastic drug processing, providing the highest level of patient, pharmacist and environmental protection. The unique demands of handling and preparing cytotoxic drugs for use in chemotherapy require a specialized cabinet.

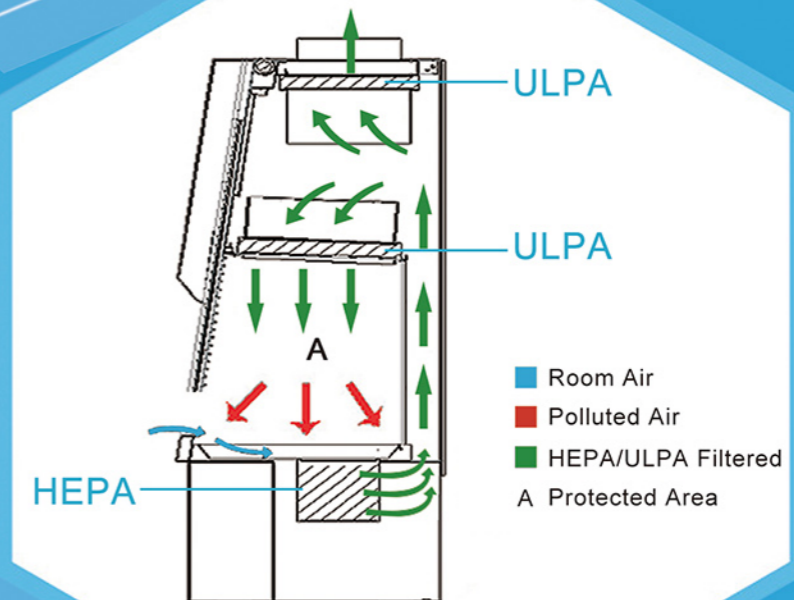



Cytotoxic Safety Cabinet



LCD Display
Large display is easy to monitor all the safety parameters at a glance, and ergonomically sized control panel improves users interface.

TECHNICAL PARAMETERS

Model	11224BBC86	11234BBC86	11244BBC86
External Size (W*D*H)	1087*760*2100mm	1380*760*2100mm	1877*760*2100mm
Internal Size (W*D*H)	910*600*630mm	1220*600*630mm	1700*600*630mm
Tested Opening	Safety Height 200mm(8")		
Max Opening	440mm(17")		
Inflow Velocity	0.53±0.025m/s		
Down Flow Velocity	0.33±0.025m/s		
Exhaust Volume	347m³/h	465m³/h	648m³/h
Air Supply Filter	ULPA filter, efficiency > 99.9995% for particle size at 0.12 μm		
Exhaust Filter	ULPA filter: first exhaust filter :0.12μm efficiency 99.9995%; HEPA filter: secondary exhaust filter :0.3μm efficiency 99.995%		
Alarm	Abnormal airflow velocity; Filter replacement; Front window at unsafe height; High filter pressure alarm		
Noise	≤ 67dB		
Water & Gas Tap	Water Tap*1, Gas tap*1		
UV Lamp	20W*1	30W*1	40W*1
	Emission of 253.7 nanometers for most efficient decontamination UV life indicator, UV timer		
LED Lamp	12W*2	16W*2	16W*2
Illumination	≥1000Lux		
Consumption	700W	900W	1300W
Waterproof Socket	Two, Total load of two sockets: ≤500W		
Display	LCD display		
Control System	Microprocessor		
Humidity and Temperature	Humidity and temperature can be displayed on the control panel		
Material	Work Area: 304 stainless steel Main Body: cold-rolled steel with anti-bacteria powder coating		
Front Window	Motorized, two-layer laminated toughened glass≥6mm, anti-UV		
Caster	Footmaster Caster		
Power supply	AC220V±10%, 50/60Hz; 110V±10%, 60Hz		
Standard Accessory	Base stand, Drain valve, Waterproof sockets*2, Remote control, LED lamp*2, UV lamp*1, Water tap, Gas tap		
Optional Accessory	Armrest, Formalin fumigation sterilizer, Infrared sterilizer, Airflow tester		
Gross Weight	320kg	371kg	430kg
Package Size (W*D*H)	1240*910*2280mm	1540*910*2280mm	2050*910*2260mm



Remote Control
All functions can be realized with it, making the operation much easier and more convenient.

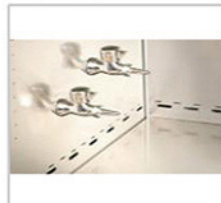

Water and Gas Tap
High quality stainless steel.

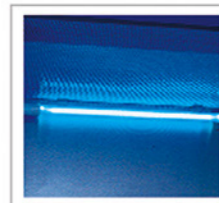

UV Lamp
Emission of 253.7 nanometers for most efficient decontamination.

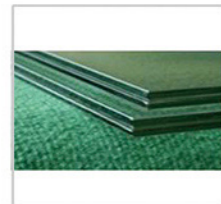

Front Window
Motorized, Two-layer laminated toughened glass >6mm, Anti UV.



Bag In and Bag Out Filter
The PVC bag can ensure the safety of the personnel and the environment, and make the replacement process convenient and quick.

Class III Biological Safety Cabinet

Class III Biosafety Cabinet is totally enclosed and gas-tight with ULPA filtered supply and exhaust air. Work is performed with long-sleeved gloves. The cabinet is kept under negative pressure of at least 120 Pa, and airflow is maintained by a dedicated exterior exhaust system. It can protect the operator, product and environment.

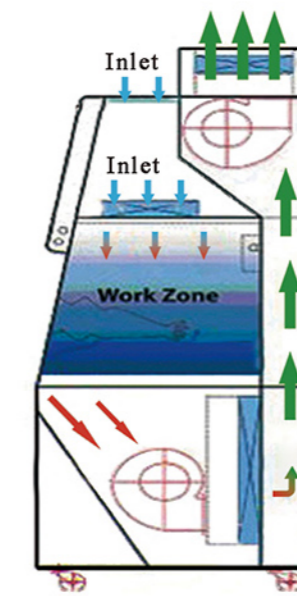



Class III Biological Safety Cabinet



Pass Box
Double doors with interlock function and UV lamp.



Pressure Meter
Display the pressure of work zone.

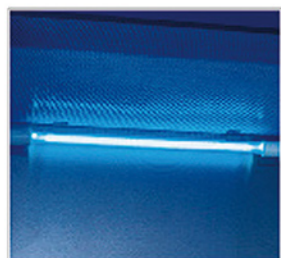

UV Lamp
Emission of 253.7 nanometers for most efficient decontamination.



LCD Display
Large display is easy to monitor the pressure parameters for work zone and three filters.

ADVANTAGE

1. With memory function in case of power-failure.
2. UV lamp ensures work area sterilization effectively.
3. An angled cabinet front ensures an ergonomic working posture.
4. Exhaust air is double-filtered through high-quality ULPA filters with typical efficiency of 99.9995% for 0.12µm particles.

TECHNICAL PARAMETERS

Model	BSC-1100III X	BSC-1500III X
External Size(W*D*H)	1540*880*2000 mm	1790*880*2080 mm
Internal Size(W*D*H)	910*650*660 mm	1165*650*660 mm
Pass Box Size(W*D*H)	Internal Size:430*330*355mm External Size:575*425*495mm	
Gloves	One pair of 800mm butyl rubber gloves	
Front Window	8 mm toughened glass, anti-ultraviolet radiation	
Display	LCD display	
Pre-Filter	Polyester fiber, washable	
Pressure	Negative, ≥ 120 Pa	
ULPA Filter	Air supply filter: Efficiency 99.9995% at 0.12µm First exhaust filter: Efficiency 99.9995% at 0.12µm Second exhaust filter: Efficiency 99.9995% at 0.12µm	
Noise	≤ 67dB	
Alarm	Audio and visual alarm, abnormal pressure; filter replacement	
Work Zone Material	304 stainless steel	
Illumination	≥ 1000 lux	
Consumption	1200W	1300W
LED Lamp	12W*2	16W*2
UV Lamp	18W*2, 8W*1	30W*2, 8W*1
	Emission of 253.7 nanometers for most efficient decontamination	
Power Supply	AC220V±10%, 50/60Hz; 110V±10%, 60Hz	
Gross Weight	350kg	450kg
Package Size(W*D*H)	1635*1065*2160mm	1890*1065*2250mm
Standard Accessories	Gloves, fluorescent lamp, UV lamp*3, remote control, pressure meter, drain valve	

Class I Biological Safety Cabinet

Personnel and environmental protection.

Class I Biosafety Cabinet is suitable for work involving low to moderate risk agents.

(Biosafety Levels 1,2 and 3) where there is a need for containment, but not for product protection.

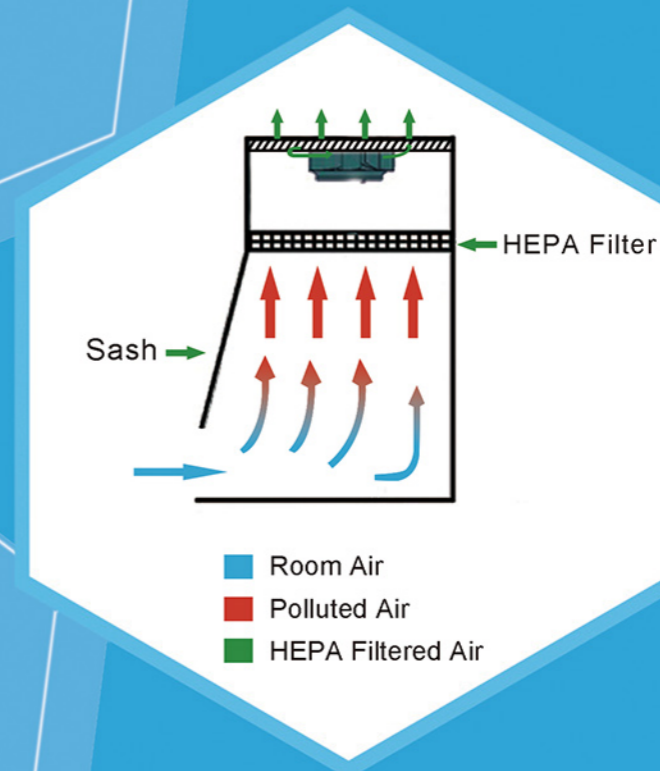



Class I Biological Safety Cabinet



BYKG-V



BYKG-I/II



BYKG-III

ADVANTAGE

1. UV lamp for sterilization.
2. Soft touch control panel, LCD display.
3. Energy-saving, high efficiency, low noise.
4. With memory function in case of power-failure.
5. One piece 304 stainless steel work table, easy for cleaning.
6. Stable air flow system; provide firm protection to people and environment.

TECHNICAL PARAMETERS

Model	BYKG-I	BYKG-II	BYKG-III	BYKG-V
External Size(W*D*H)	550*395*730mm	700*550*900mm	900*713*1250mm	1100*697*1900mm
Internal Size(W*D*H)	540*385*440mm	680*540*500mm	800*635*600mm	968*625*630mm
HEPA Filter	99.995% efficiency at 0.3um			
Airflow Velocity	>0.3m/s	0.75~1.0m/s	>0.3m/s	0.75~1.0m/s
Noise	≤60dB	≤55dB	≤60dB	≤67dB
Illuminating Lamp	4W*1	8W*1	8W*1	12W*2
	LED lamp	LED lamp	LED lamp	Fluorescent lamp
UV Lamp	15W*1	20W*1	20W*1	20W*1
	Emission of 253.7 nanometers for most efficient decontamination BYKG-III has UV timer function and the display could indicate the UV life.			
Power Consumption	150W	160W	400W	350W
Work Surface Height	/	/	/	750mm
Caster	/	/	/	Universal caster
Main Body Construction	PMMA	PMMA	Cold-rolled steel with anti-bacteria powder coating, tempered glass	
Work Table	304 stainless steel			
Power Supply	AC220V±10%, 50/60Hz; 110V±10%, 60Hz			
Standard Accessory	LED lamp, UV lamp*2			Fluorescent lamp,
				UV lamp*2, Base stand
Optional Accessory	Electric height adjustable base stand			
Gross Weight	38kg	68kg	147kg	185kg
Package Size(W*D*H)	710*550*950mm	870*720*1170mm	1060*870*1440mm	1260*860*2080mm

Biosafety Accessories

Electric Height Adjustable Base Stand



APPLICATIONS

For biosafety cabinet, laminar flow cabinet, fume hood and other laboratory equipment which need adjustable height base stand.

FEATURES

1. Heavy load and smart balance
2. Smooth running speed and low noise
3. Concise and easy with nice appearance
4. Low maintenance cost
5. Easy to install and disassemble
6. Max Adjustable Route 400 mm
7. Width adjustable is customized
8. Multipurpose for laboratory apparatus



Control Button



Footmaster Caster

TECHNICAL PARAMETERS

Max Route(mm)	100	150	200	250	300	350	400
Height of Min.Height(mm)	440	490	540	590	640	690	740
Base Stand Max.Height(mm)	540	640	740	840	940	1040	1140
Max Load	400kg						
Load Speed	5mm/s						
Working Frequency	10%, max continuous working time is 2 minutes						
Noise	<65dB						
Work Temperature	-26°C~65°C						
Material	Pedestal: 3.0mm steel Lifting Rod: Aluminium alloy						
Power Supply	AC220V±10%, 50/60Hz; 110V±10%, 60Hz						
Controller Consumption	100~200W						
Caster	Footmaster Caster						
Applications	For biosafety cabinet, laminar flow cabinet, fume hood and other laboratory equipment						



Airflow Tester

Particle Distribution: The proportion of particle diameter smaller than 5 um is no less than 90%
 Nebulization Rate: >0.25 mL/min
 Working Frequency: 110KHz±10%
 Working Mode: Continuous working
 Power Supply: Two "AA" batteries or power adapter (DC 5V)
 Safety Classification: Class II, type BF applied part



Air Velocity Meter

Measurement Range: 0~30m/s
 Accuracy: ±3% or ± 0.015m/s
 Resolution: 0.01m/s
 Data log 12,700+samples and 100 test IDs
 The 9535 model comes with a telescopic straight probe.
 The 9535-A model comes with an articulated probe.



Dust Particle Counter

Particle Size Channel: 0.3, 0.5, 1.0, 3.0, 5.0, 10.0(µm)
 Sampling period: 1-9999s
 Number of sampling point: 2~9
 Sampling frequency: 2~9
 Sampling quantity: 2.83L/min(0.1cfm)



Digital Sound Level Meter

Measurement Range: 30-130dB
 Accuracy: ±1.5dB
 Resolution: 0.1dB



Illumination Meter

Light Intensity range: 0-200,000LUX
 Accuracy: ±3% rdg±0.5% f.s. (<10,000lux)
 ±4% rdg±10dpts (>10,000lux)



Infrared Sterilizer

Two types:
 Type I: 36mm dimension of cavity
 Type II: 22mm dimension of cavity
 Central high-temperature: 930°C±30°C
 Heat-up Time: 20min Size: 150*95*210mm
 Package Size (W*D*H): 266*225*145mm
 Weight: 1600g Power: 180W
 Voltage: 110/220V, 50/60Hz



Foot rest

Humanization design.
 Material is cold-rolled steel with anti-bacteria powder coating.
 Can be customized.



Arm rest

Alleviate fatigue on operator's arms
 Prevent air obstruction
 Adjustable height range: 85~100mm



Formalin Fumigation Sterilizer Ammonium Hydrogen Carbonate Neutralizer

Sterilize the cabinet with formalin for 8 hours and neutralize the formalin with ammonium hydroxide carbonate for 8 hours.



Laboratory Chair

Material: Economy line-artificial leather
 Backrest height: 45cm
 Height range: 43~57cm

Laminar Flow Cabinet

Laminar Flow Cabinet - sample protection only

Laminar Flow Cabinet is a work bench or similar enclosure, which creates a particles-free working environment by taking air through a filtration system and exhausting it across a work surface in a laminar or unidirectional air stream. The laminar flow cabinet is enclosed on the sides and kept under constant positive pressure in order to prevent the infiltration of contaminated room air.

Laminar flow cabinet is widely used in medical research laboratories, hospital, manufacturing facilities and other research and production environments.

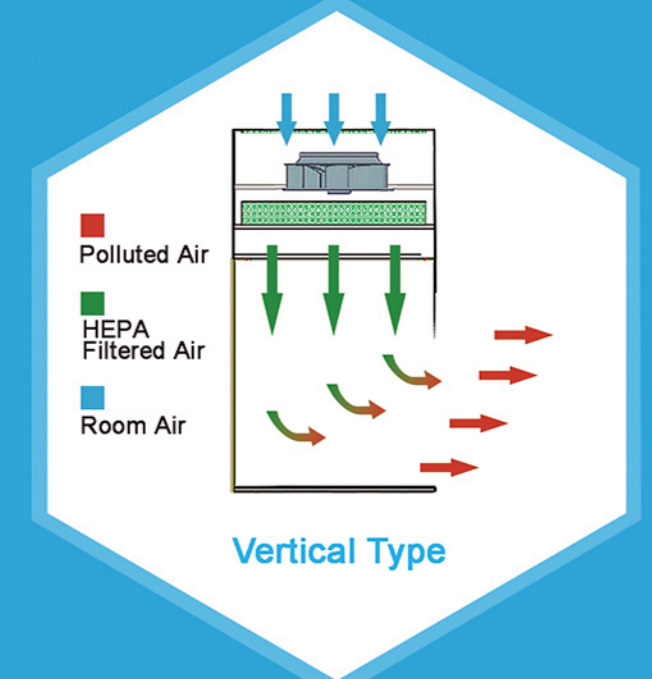
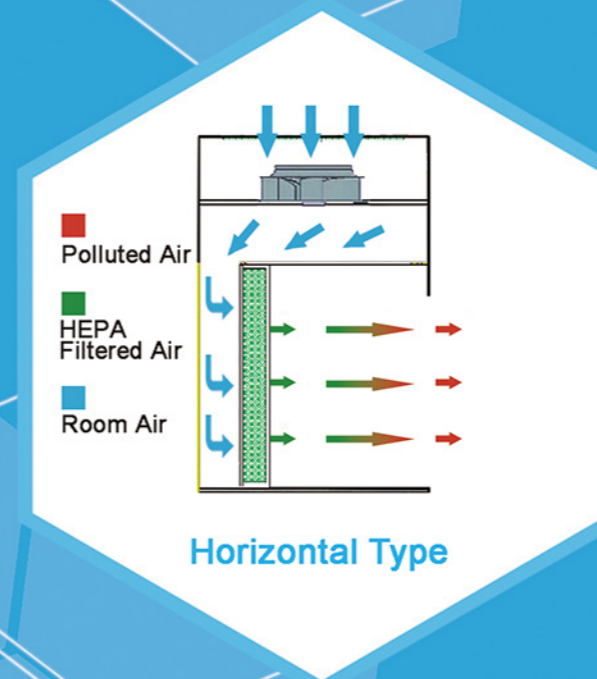



ETL Certified Horizontal Laminar Flow Cabinet



**Stainless Steel I.V.
Bar with 10 hooks**



Waterproof Socket
America Standard



Footmaster Caster
Universal caster with brake
and leveling feet

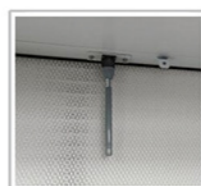

Wind Speed Sensor
Direct measurement of wind speed

ADVANTAGE

1. ETL certification, Satisfy North American market.
2. With memory function in case of power-failure.
3. Audio and visual alarm (Abnormal airflow velocity).

TECHNICAL PARAMETERS

Model	BBS-H800	BBS-H1100	BBS-H1300	BBS-H1500	BBS-H1800
External Size(W*D*H)	800*810* (1720~1980)mm	1100*810* (1720~1980)mm	1300*810* (1720~1980)mm	1500*810* (1720~1980)mm	1800*810* (1720~1980)mm
Internal Size(W*D*H)	700*500*600mm	1000*500*600mm	1200*500*600mm	1400*500*600mm	1700*500*600mm
Work Surface Height	750~1010mm				
Max Opening	440mm				
Display	LCD Display				
Airflow Velocity	80~99fpm				
Material	Working area: 304 stainless Steel. Main Body: 1.0 mm Cold-rolled steel with anti-bacteria powder coating. Front Window: 5 mm toughened glass, anti-UV.				
Pre-Filter	Polyester fiber				
HEPA Filter	One,99.995% efficiency at 0.3um				
Noise	≤68dB(A)				
Illumination	≥300lx				
Waterproof Sockets	One socket (Double type), America standard, Max.Power: 500W				
Power Supply	103.5~126.5V, 60Hz, 10A				
Consumption	750W	950W	950W	950W	1150W
LED Lamp	10W*1	14W*1	14W*1	18W*1	22W*1
Standard Accessory	Manually height adjustable base stand,LED lamp, wind speed sensor, waterproof socket , Stainless Steel I.V.Bar with 10 hooks				
Optional Accessory	UV lamp				
Package Size (W*D*H)	940*1090*1250mm	1240*1090*1250mm	1440*1090*1250mm	1640*1090*1250mm	1940*1090*1250mm
Gross Weight	150kg	190kg	225kg	265kg	300kg



Horizontal Laminar Flow Cabinet



LCD Display
Airflow velocity, UV timer, UV work time, system work time, real time.



Waterproof Socket
2 waterproof sockets are located in the side panel, for optimum convenience of using small devices inside the cabinet.



Gas Tap

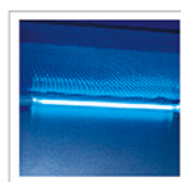

UV Lamp
Emission of 253.7 nanometers for most efficient decontamination



Side Glass Window
The transparent side glass windows maximize light and visibility inside the cabinet, providing a bright and open working environment.

TECHNICAL PARAMETERS

Model	BBS-H1300	BBS-H1800
External Size (W*D*H)	1300*820*2040mm	1800*820*2070mm
Internal Size (W*D*H)	1200*500*570mm	1700*500*570mm
Work Surface Height	750mm	
Display	LCD Display	
Airflow Velocity	Average of 0.3~0.5m/s	
Material	Main Body: Cold-rolled steel with anti-bacteria powder coating Work Table: 304 stainless steel Side and Front Window: 5mm toughened glass, anti-UV	
Pre-Filter	Polyester fiber, washable	
HEPA Filter	99.995% efficiency at 0.3µm	
Noise	<65dB	
Front Window	Motorized	
Max Opening	430mm	
LED Lamp	12W*1	16W*2
UV Lamp	30W*1	30W*1
	Emission of 253.7 nanometers	
Consumption	400W	500W
Waterproof Socket	Two, total load≤500W	
Caster	Universal caster with leveling feet	
Power Supply	AC220V±10%, 50/60Hz; 110V±10%, 60Hz	
Standard Accessory	LED lamp, UV lamp*2, Base stand, Gas Tap, Waterproof socket*2 Water tap(only for BBS-H1800)	
Optional Accessory	Electric height adjustable base stand	
Gross Weight	254kg	328kg
Package Size(W*D*H)	1450*1060*1650mm	1950*1060*1600mm



Horizontal Laminar Flow Cabinet



LCD Display

Microprocessor control system,
LCD display



Waterproof Socket

2 waterproof sockets are located
in the top panel, for optimum
convenience of using small
devices inside the cabinet.



Side Glass Window

The transparent side glass windows
maximize light and visibility inside
the cabinet, providing a bright and
open working environment.

TECHNICAL PARAMETERS

Model	BBS-H1100 (Previous name: BBS-DDS)	BBS-H1500 (Previous name: BBS-SDS)	BBS-H1800(X)
External Size (W*D*H)	1100*808*1690mm	1500*808*1690mm	1800*808*1890mm
Internal Size (W*D*H)	1000*500*600mm	1400*500*600mm	1700*500*800mm
Work Surface Height	750mm		
Display	LCD Display		
Airflow Velocity	Average of 0.30~0.45m/s		
Material	Main Body: Cold-rolled steel with anti-bacteria powder coating Work Table: 304 stainless steel Side Windows: 8mm toughened glass, anti-UV		
Pre-Filter	Polyester fiber, washable		
HEPA Filter	99.995% efficiency at 0.3µm		
Noise	≤65dB(A)		
LED Lamp	12W*1	16W*1	16W*2
UV Lamp	20W*1	30W*1	20W*2
	Emission of 253.7 nanometers		
Consumption	200W	300W	400W
Waterproof Socket	Two, total load≤500W		
Caster	Universal caster with leveling feet		
Power Supply	AC220V±10%, 50/60Hz; 110V±10%, 60Hz		
Standard Accessory	LED lamp, UV lamp*2, Base stand, Waterproof socket*2, Hook*10		
Optional Accessory	Electric height adjustable base stand		
Gross Weight	175kg	216kg	255kg
Package Size(W*D*H)	1250*1050*1350mm	1650*1050*1350mm	1950*1050*1550mm



ETL Certified Vertical Laminar Flow Cabinet

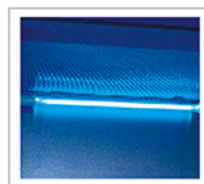

UV Lamp
Emission of 253,7nanometers
For most efficient decontamination



Waterproof Socket
America Standard



Footmaster Caster
Universal caster with brake
and leveling feet

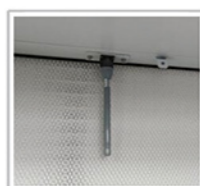

Wind Speed Sensor
Direct measurement of wind speed

ADVANTAGE

1. ETL certified, Satisfy North American market.
2. With memory function in case of power-failure.
3. Audio and visual alarm(Abnormal airflow velocity).
4. Interlock function: UV Lamp and blower, LED Lamp.

TECHNICAL PARAMETERS

Model	BBS-V800	BBS-V1100	BBS-V1300	BBS-V1500	BBS-V1800
External Size(W*D*H)	800*700* (2090~2340)mm	1100*700* (2090~2340)mm	1300*700* (2090~2340)mm	1500*700* (2090~2340)mm	1800*700* (2090~2340)mm
Internal Size(W*D*H)	700*575*625mm	1000*575*625mm	1200*575*625mm	1400*575*625mm	1700*575*625mm
Work Surface Height	750~1010mm				
Max Opening	480mm				
Display	LCD Display				
Airflow Velocity	80~99fpm				
Material	Working area: 304stainless Steel				
	Main Body: 1.2mm Cold-rolled steel with anti-bacteria powder coating. Front Window: Motorized,5mm toughened glass, anti-UV				
Pre-Filter	Polyester fiber				
HEPA Filter	One,99.995% efficiency at 0.3um				
Noise	≤68dB(A)				
Illumination	≥300lx				
Waterproof Sockets	One socket (Double type), America standard, Max.Power: 500W				
Power Supply	110V±10% 60HZ				
Consumption	750W	950W	950W	950W	1150W
UV Lamp	18W*1	30W*1	30W*1	40W*1	40W*1
LED Lamp	10W*1	14W*1	14W*1	18W*1	22W*1
Standard Accessory	Manually height adjustable base stand,LED lamp, UV lamp, wind speed sensor, waterproof socket				
Package Size (W*D*H)	940*970*1560mm	1240*970*1560mm	1440*970*1560mm	1640*970*1560mm	1940*970*1560mm
Gross Weight	190kg	230kg	265kg	280kg	320kg



Vertical Laminar Flow Cabinet



LCD Display

Airflow velocity, UV timer, UV work time, system work time, real time.



Waterproof Socket

2 waterproof sockets are located in the side panel, for optimum convenience of using small devices inside the cabinet.



Gas Tap

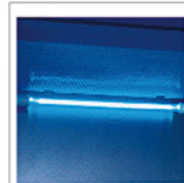

UV Lamp

Emission of 253.7 nanometers for most efficient decontamination.



Side Glass Window

The transparent side glass windows maximize light and visibility inside the cabinet, providing a bright and open working environment.

TECHNICAL PARAMETERS

Model	BBS-V1300	BBS-V1800
External Size (W*D*H)	1300*750*2040mm	1800*750*2040mm
Internal Size (W*D*H)	1200*645*610mm	1700*645*610mm
Work Surface Height	750mm	
Display	LCD Display	
Airflow Velocity	Average of 0.3~0.5m/s	
Material	Main Body: Cold-rolled steel with anti-bacteria powder coating Work Table: 304 stainless steel Side and Front Windows: 5mm toughened glass anti-UV	
Pre-Filter	Polyester fiber, washable	
HEPA Filter	99.995% efficiency at 0.3µm	
Noise	<65dB	
Front Window	Motorized	
Max Opening	430mm	430mm
LED Lamp	12W*1	16W*1
UV Lamp	30W*1	40W*1
	Emission of 253.7 nanometers	
Consumption	400W	450W
Waterproof Socket	Two, total load≤500W	
Caster	Universal caster with leveling feet	
Power Supply	AC220V±10%, 50/60Hz; 110V±10%, 60Hz	
Standard Accessory	LED lamp, UV lamp*2, Base stand, Gas Tap, Waterproof socket*2	
Optional Accessory	Electric height adjustable base stand	
Gross Weight	228kg	306kg
Package Size (W*D*H)	1460*1070*1650mm	1960*970*1600mm



Vertical Laminar Flow Cabinet



BBS-DDC/BBS-SDC



BBS-V680



BBS-V800

TECHNICAL PARAMETERS

Model	BBS-V680	BBS-V800	BBS-DDC	BBS-SDC
External Size (W*D*H)	680*410*1160mm	802*650*1550mm	1060*620*1850mm	1460*620*1850mm
Internal Size (W*D*H)	630*375*615mm	800*530*540mm	935*530*650mm	1335*530*650mm
Work Surface Height	/	660mm	750mm	750mm
Display	LED Display		LCD Display	
Airflow Velocity	Average of 0.3~0.5m/s, air speed adjustable		Average of 0.3~0.45m/s, air speed adjustable	
Material	Main Body: Cold-rolled steel with anti-bacteria power coating Work Table: 304 stainless steel(except model BBS-V680)			
Pre-Filter	Polyester fiber, washable			
HEPA Filter	99.995% efficiency at 0.3 μm			
Noise	<65dB			
Front Window	/	Manual, 5mm toughened glass, anti-UV		
Max Opening	/	490mm	400mm	400mm
Illuminating Lamp	Fluorescent lamp 8W*1	LED lamp 8W*1	LED lamp 12W*1	LED lamp 16W*1
UV Lamp	15W*1	20W*1	20W*1	40W*1
	Emission of 253.7 nanometers			
Consumption	160W	350W	150W	250W
Standard Accessory	Fluorescent lamp UV lamp*2 Water & gas tap	LED lamp UV lamp*2 Base stand	LED lamp UV lamp*2 Base stand	LED lamp UV lamp*2 Base stand
Optional Accessory	/	Electric height adjustable base stand		
Caster	/	Universal wheel with leveling feet		
Power Supply	AC220V±10%, 50/60Hz; 110V±10%, 60Hz			
Gross Weight	50kg	116kg	185kg	231kg
Package Size (W*D*H)	840*560*1380mm	960*800*1800mm	1240*900*1350mm	1640*900*1350mm



Vertical Laminar Flow Cabinet

---Double Sides Type



LED Display
Microprocessor control system, LED display

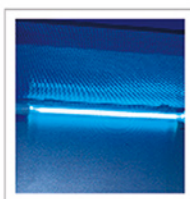

UV Lamp
Emission of 253.7 nanometers for most efficient decontamination



Double Sides
Double sides work bench, operators can sit face to face

ADVANTAGE

1. With memory function in case of power-failure.
2. Double sides work bench, 2~4 operators can work together.

TECHNICAL PARAMETERS

Model	BBS-DSC	BBS-SSC
External Size (W*D*H)	1040*660*1770mm	1440*660*1770mm
Internal Size (W*D*H)	940*560*545mm	1340*560*545mm
Work Surface Height	750mm	
Display	LED Display	
Airflow Velocity	Average of 0.3~0.5m/s	
Material	Main Body: Cold-rolled steel with anti-bacteria powder coating Work Table: 304 stainless steel	
Pre-Filter	Polyester fiber, washable	
HEPA Filter	99.995% efficiency at 0.3µm	
Noise	<65dB	
Front Window	Manual, 5mm toughened glass, anti-UV	
Max Opening	310mm	
UV Lamp	20W*1	30W*1
	Emission of 253.7 nanometers	
LED Lamp	12W*1	16W*1
Consumption	350W	600W
Caster	Universal caster with leveling feet	
Power Supply	AC220V±10%, 50/60Hz; 110V±10%, 60Hz	
Standard Accessory	LED lamp, UV lamp*2, Base stand	
Optional Accessory	Electric height adjustable base stand	
Gross Weight	150kg	186kg
Package Size (W*D*H)	1190*890*1340mm	1590*890*1340mm



Compounding Hood



BBS-V500 & BYKG-VII



BBS-V600 & BYKG-VIII

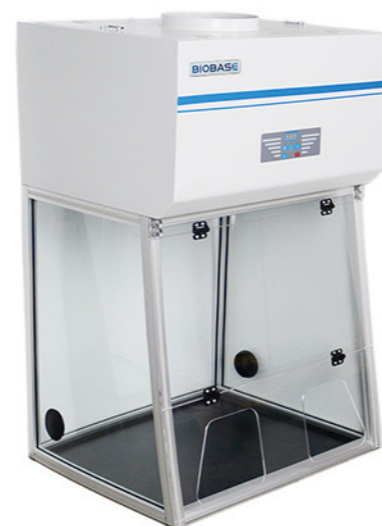

BBS-V700 & BYKG-IX
BYKG-X & BYKG-XII

There are two types:

- Positive pressure in work area only protects sample.

BBS-V500	BBS-V600	BBS-V700
LED Display	LCD Display	LED Display
HEPA Filter	HEPA Filter	
Glass Front Window	Acrylic Front Window	

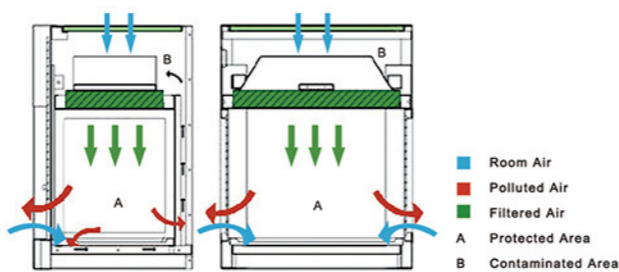

- Negative pressure in work area protects operator and environment.

BYKG-VII	BYKG-VIII	BYKG-IX	BYKG-X	BYKG-XII
LED Display	LCD Display	LED Display		
Active Carbon Filter, HEPA Filter	Active Carbon Filter		Active Carbon Filter, HEPA Filter	
Glass Front Window	Acrylic Front Window			

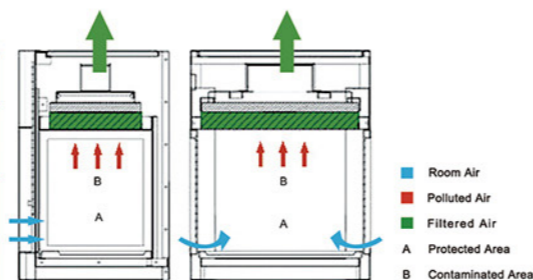

TECHNICAL PARAMETERS

Model	BBS-V500	BYKG-VII	BBS-V600	BYKG-VIII	BBS-V700	BYKG-IX	BYKG-X	BYKG-XII
External Size (W*D*H)	550*460*700mm		600*580*1060mm		700*620*1150mm		1000*620*1150mm	1200*620*1150mm
Internal Size (W*D*H)	480*340*370mm		580*520*610mm		640*550*700mm		940*550*700mm	1140*550*700mm
Display	LED Display		LCD Display		LED Display			
Airflow Velocity	0.3~0.5m/s	≥0.5m/s	0.3~0.5m/s	0.3~0.8m/s	0.3~0.5m/s	0.3~0.8m/s		
Material	Main Body	Cold-rolled steel with anti-bacteria powder coating						
	Work Table	304 stainless steel					Solid physicochemical steel plate	
Pre-Filter	Polyester fiber, washable (for BBS-V500, BBS-V600 and BBS-V700)							
Filter	HEPA Filter	Active Carbon Filter, HEPA Filter	HEPA Filter	Active Carbon Filter	HEPA Filter	Active Carbon Filter	Active Carbon Filter, HEPA Filter	
Noise	≤60dB							
Front Window	Manual, 5mm toughened glass, anti UV			Manual, acrylic material				
Max Opening	300mm		590mm		660mm			
LED Lamp	4W*1				4W*2		12W*1	
UV Lamp	8W*1				15W*1			
	Emission of 253.7 nanometers							
Consumption	100W		150W		300W		200W	
Power Supply	AC220V±10%, 50/60Hz; 110V±10%, 60Hz							
Standard Accessory	HEPA Filter, LED Lamp, UV Lamp*2.	Active Carbon Filter, HEPA Filter, LED Lamp, UV Lamp*2.	HEPA Filter, LED Lamp, UV Lamp*2, Waterproof Socket.	Active Carbon Filter, LED Lamp, UV Lamp*2, Waterproof Socket.	HEPA Filter, LED lamp*2, UV lamp*2	Active Carbon Filter, HEPA Filter(only for BYKG-X BYKG-XII) LED Lamp*1,(LED Lamp*2 for BYKG-IX) 4 Meters PVC exhaust duct,diameter:250mm		
Optional Accessory	/		Base stand			Base Stand, UV Lamp*2		
Gross Weight	57kg		90kg		100kg		145kg	
Package Size (W*D*H)	700*610*925mm		760*740*1280mm		840*760*1400mm		1140*740*1340mm	
							190kg	
							1340*740*1360mm	



PCR Cabinet



PCR1000



**PCR800/PCR1200/
PCR1300/PCR1500**



LCD Display
LCD Display(not including PCR-1000,
PCR-1000's display is LED)



Waterproof Socket
2 waterproof sockets are located
in the back wall, for optimum
convenience of using small
devices inside the cabinet.

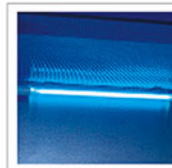

UV Lamp
Emission of 253.7 nanometers for
most efficient decontamination.



Shelf with IV Bar

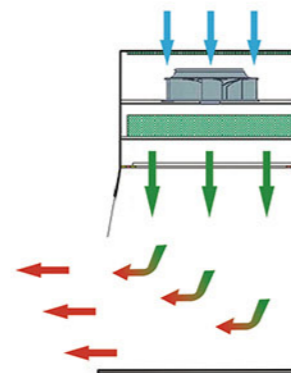

■ Polluted Air
■ HEPA Filtered Air
■ Room Air



Side Glass Window
Side glass windows maximize
light and visibility inside the
cabinet, providing a bright and
open working environment.

ADVANTAGE

1. LCD display (LED display for PCR1000).
2. UV sterilization system.
3. HEPA filter efficiency 99.999% at 0.3µm.
4. With memory function in case of power-failure.
5. Interlock function: UV lamp only can be switched on when the front window is closed, ensuring operator safety.
6. UV timer (0-90 minutes): When the setting time expires, the UV lamp automatically switches off in preparation for the next experiment.

TECHNICAL PARAMETERS

Model	PCR800	PCR1000	PCR1200	PCR1300	PCR1500
External Size (W*D*H)	800*700*1770mm	1000*705*1770mm	1200*700*1770mm	1300*700*1770mm	1500*700*1770mm
Internal Size (W*D*H)	700*595*550mm	900*595*560mm	1100*595*550mm	1200*595*550mm	1400*595*550mm
Work Surface Height	750mm				
Material	Main Body: Cold-rolled steel with anti-bacteria powder coating Work Table: 304 stainless steel				
Front & Side Windows	5mm toughened glass , anti-UV				
	Motorized	Manual	Motorized		
Max Opening	300mm	320mm	300mm	300mm	300mm
Pre-Filter	Polyester fiber, Washable				
HEPA Filter	99.995% efficiency at 0.3µm.				
Airflow Velocity	0.3-0.5m/s, speed adjustable				
Noise	≤65dB				
UV Lamp	20W*1	20W*2	30W*1	30W*1	40W*1
	Emission of 253.7 nanometers, with UV timer				
LED Lamp	8W*2		12W*2		
Illumination	≥350lx				
Shelf with IV Bar	Stainless steel, 502*150*50mm (W*D*H)				
Caster	Universal caster with leveling feet				
Consumption	400W	300W	600W	600W	600W
Waterproof Socket	Two, total load≤500W				
Power Supply	AC220V±10%, 50/60Hz; 110V±10%, 60Hz				
Standard Accessory	UV lamp, Fluorescent lamp, Base stand, Waterproof socket*2, Shelf with IV bar				
Optional Accessory	Electric height adjustable base stand				
Gross Weight	168kg	178kg	220kg	231kg	250kg
Package Size (W*D*H)	960*940*1450mm	1150*930*1450mm	1350*930*1450mm	1450*930*1450mm	1650*930*1450mm

Fume Hood

Fume Hood is used to protect lab environment and operator during general chemical applications. It actively protects operator from inhaling toxic vapors and dramatically reduces the risk of fire and explosion. By installing proper filter, it can also protect environment.

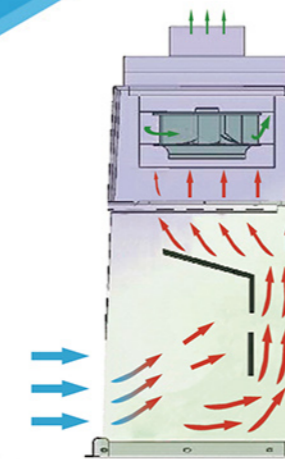



Ducted Fume Hood

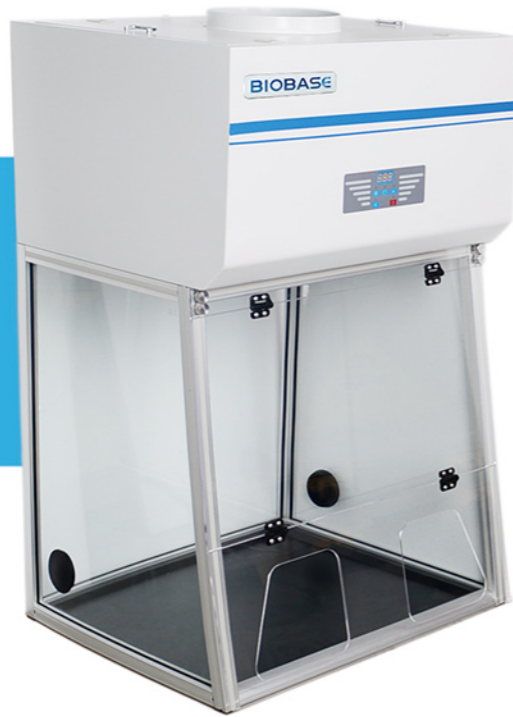

Fume hood FH700: Negative pressure in work area protects operator and environment.

Air Flow Pattern:

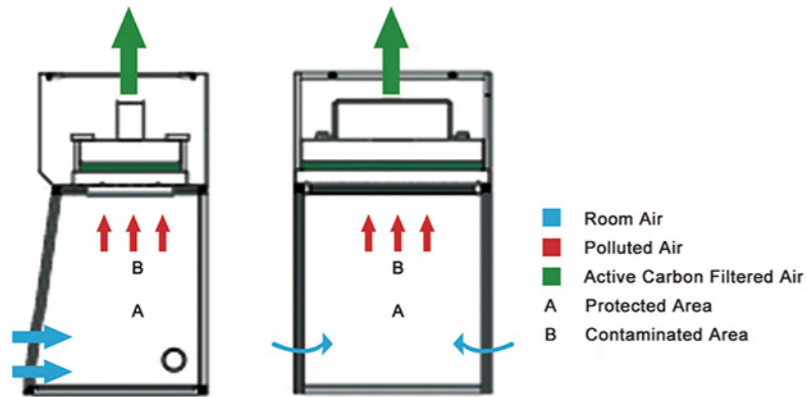

LED Display
Digital LED display: Airflow Level



Folding acrylic front window, down part with free stop function



Three Side Glass Windows
Back&Side glass windows maximize light and visibility, providing a bright and open working environment



Base Stand
Optional

ADVANTAGE

1. Folding acrylic front window, down part with free stop function.
2. Microprocessor control system, LED display.
3. With memory function in case of power-failure.
4. Built-in centrifugal blower.
5. Interlock function: UV lamp and blower, LED lamp. (Only for choosing UV lamp).

Note: Experiments with strong acids and alkali, flammable or explosive substances cannot be conducted with this type fume hood.

TECHNICAL PARAMETERS

Model	FH700	
External Size(W*D*H)	700*620*1150mm	
Internal Size(W*D*H)	640*550*700mm	
Max Opening	660mm	
Air Velocity	0.3~0.8m/s	
Noise	≤65dB	
LED Lamp	4W*2	
Blower	Built-in centrifugal blower; Speed adjustable	
Front Window	Folding acrylic window, down part with free stop function	
Material	Main Body	1.0mm cold-rolled steel with bacteria power coating
	Work Table	Chemical resistant phenolic resin
	Back&Side Windows	5mm toughened glass
Consumption	200W	
Power Supply	AC220V±10%, 50/60Hz; 110V±10%, 60Hz	
Standard Accessory	LED lamp, Active carbon filter, Blower, 4.3 meters PVC exhaust duct, Pipe strap	
Optional Accessory	15W UV lamp, HEPA filter, Base stand	
Gross Weight without Base Stand	100kg	
Gross Weight with Base Stand	115kg	
Package Size without Base Stand (W*D*H)	840*760*1400mm	
Package Size with Base Stand (W*D*H)	840*960*1400mm	



Ducted Fume Hood



ADVANTAGE

1. Adjustable air speed: 9 levels.
2. Microprocessor control system, LED display.
3. Resistant to moderate acid and alkali.
4. With memory function in case of power-failure.
5. Manual front glass window, height adjustable.
6. Built-in PP centrifugal blower; low noise, easy installation.

TECHNICAL PARAMETERS

Model	FH1000(E)	FH1200(E)	FH1500(E)	FH1800(E)	
External Size(W*D*H)	1000*800*2515mm	1200*800*2515mm	1500*800*2515mm	1800*800*2515mm	
Internal Size(W*D*H)	790*600*870mm	990 *600*870mm	1290*600*870mm	1590*600*870mm	
Work Surface Height	900mm				
Max Opening	750mm				
Air Velocity	0.3~0.8m/s				
System Exhaust Volume	570 m³/h	710 m³/h	930 m³/h	1140 m³/h	
Noise	≤68dB				
Exhaust Duct	PVC,Standard length; 4.3 meters,Φ300mm				
Pipe Strap	2 pcs				
LED Lamp	20W *1		40W *1		
Blower	Built-in PP centrifugal blower				
Front Window	Manual, 5mm toughened glass, height adjustable				
Power Supply	220V±10%, 60/50Hz; 110V±10%, 60Hz				
Consumption	400W	400W	500W	500W	
Material	Exterior	1.0mm cold-rolled steel with bacteria power coating.			
	Interior	Compact laminate board with good acid and alkali resistance function			
	Work table	Chemical resistant phenolic resin			
Standard Accessory	PP Water sink, Total load of 2 waterproof sockets: 500w,Base cabinet, Water tap,4 meters Exhaust duct(φ300mm).				
Optional Accessory	Air supply flow control valve, gas faucet.				
Gross Weight	270kg	305kg	335kg	365kg	
Package	Main Body	1140*940*1900mm	1340*940*1900mm	1640*940*1900mm	1940*940*1900mm
	Base Cabinet	1140*940*1050mm	1340*940*1050mm	1640*940*1050mm	1940*940*1050mm



LED Display
Digital LED display:
Airflow Level



Waterproof Socket



Universal Wheel



Water Remote Control



Water Tap



Water Tap & Water Sink



Ducted Fume Hood



LED Display



Waterproof Socket



Water&Gas Remote Control

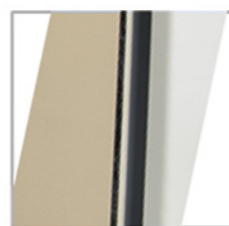

Double Layer
1.2mm sheet metal surface,
melamine board inward.

ADVANTAGE

1. UV lamp for sterilization.
2. resistant to weak acid and alkali.
3. Adjustable air speed: 9 levels.
4. Motorized front window, height adjustable.
5. Microprocessor control system, LED display.
6. With memory function in case of power-failure.

TECHNICAL PARAMETERS

Model	FH1000(A)	FH1200(A)	FH1500(A)	FH1800(A)
External Size (W*D*H)	1040*800*2200mm	1240*800*2200mm	1540*800*2200mm	1840*800*2200mm
Internal Size (W*D*H)	820*670*730mm	1020*670*730mm	1320*670*730mm	1620*670*730mm
Work Surface Height	850mm			
Max Opening	520mm			
Air Velocity	0.3~0.8m/s			
Noise	≤68dB			
Exhaust Duct	PVC, Standard length: 4 meters. Φ300mm			
LED Lamp	8W*1	12W*1	16W*1	16W*1
UV Lamp	Emission of 253.7 nanometers for most efficient decontamination			
Blower	Built-in centrifugal blower; Speed adjustable			
Front Window	5mm toughened glass; Motorized; Height adjustable			
Power Supply	AC220V±10%, 50/60Hz; 110V±10%, 60Hz			
Consumption	400W	400W	500W	500W
Material	Exterior	Cold-rolled steel with anti-bacteria powder coating.		
	Interior	Compact laminate board with good acid and alkali resistance function		
	Work Table	Chemical resistant phenolic resin		
Standard Accessories	UV lamp*2, LED lamp, Water tap, Gas tap, Water sink, Base cabinet			
	Total load of 2 waterproof sockets: 500W 4.3 meter PVC exhaust duct, pipe strap*2			
Optional Accessory	Active carbon filter, HEPA filter			
Gross Weight	286kg	317kg	350kg	400kg
Package	Main Body	1190*990*1690 mm	1390*990*1690 mm	1690*990*1690mm
	Base Cabinet	1190*990*900mm	1390*990*900mm	1690*990*900mm



Ducted PP Fume Hood

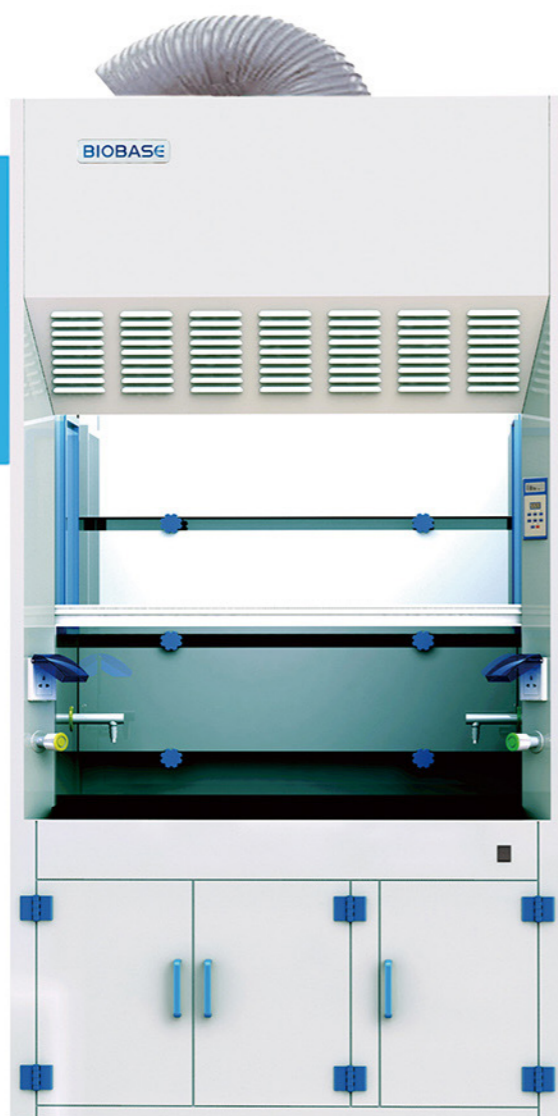

LED Display



Waterproof Socket



PP Sink
resistant to acid,
alkali and anti-corrosion



Water&Gas
Remote Control

ADVANTAGE

1. It is safer to use anti-corrosive water tap.
2. Microprocessor control system, LED display.
3. With memory function in case of power-failure.
4. Made of porcelain white PP, resistant to acid, alkali and anti-corrosion.
5. Front window which is made of 5mm thick transparent toughened glass maximize light and visibility inside the fume hood, providing a bright and open working environment.

TECHNICAL PARAMETERS

Model	FH1000(P)	FH1200(P)	FH1500(P)	FH1800(P)	
External Size (W*D*H)	1047*800*2450mm	1247*800*2450mm	1547*800*2450mm	1847*800*2450 mm	
Internal Size (W*D*H)	787*560*700mm	987*560*700mm	1287*560*700mm	1587*560*700 mm	
Work Surface Height	820mm				
Max Opening	740mm				
Air Velocity	0.3~0.8m/s				
Noise	≤68dB				
Exhaust Duct	4.3meters,Φ250mm				
LED Lamp	12W*2	12W*2	22W*2	18W*2	
Blower	Built-in PP centrifugal blower (2 blowers for FH1800(P) only); Speed adjustable				
Front Window	Resistant to acid and alkali, Manual, 5mm toughened glass, height adjustable				
Power Supply	AC220V±10%, 50/60Hz; 110V±10%, 60Hz				
Consumption	400W	400W	500W	700W	
Material	Main Body	Made of Porcelain white PP, thickness 8mm, resistant to strong acid, alkali and anti-corrosion			
	Work Table	Chemical resistant phenolic resin			
Standard Accessory	LED light;Work table:Chemical resistant phenolic resin; 4.3 meters PVC duct (2 Pcs of 4.3 meters PVC duct for FH1800(P) only), Diameter: 250mm; Pipe strap*2(4 Pcs for FH1800(P) only); RVV power cord (3*1.0mm**3000mm); Base cabinet; Waterproof socket*2; Tail insert; Water tap(PP); Gas tap(PP); Water Sink; PP centrifugal blower*1(2 for FH1800(P) only)				
Optional Accessory	PP work table, epoxy resin board or ceramic board;Active carbon filter; Outer PP centrifugal blower *1 (only need to select when the duct more than 4m,2 for FH1800(P) only); Splicable base cabinet(only not for FH1800(P))				
Gross Weight	Main Body	137kg	155kg	180kg	206kg
	Base Cabinet	89kg or 80kg(Spllicable)	99kg or 90kg(Spllicable)	114kg or 102kg(Spllicable)	140kg
Package Size (W*D*H)	Main Body	1188*938*1612mm	1388*938*1612mm	1688*938*1612mm	1988*938*1612mm
	Base Cabinet	1188*888*1000mm or (Spllicable)	1388*888*1000mm or (Spllicable)	1688*888*1000mm or (Spllicable)	1988*888*1000mm



Ducted Fume Hood



LED Display
Digital LED display: Airflow Level



**Water & Gas Tap
Water Sink**



Foot Switch
Use foot switch to adjust the height of front window.

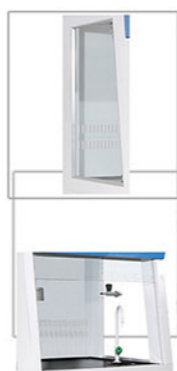

Observation Window
Transparent side glass windows maximize light and visibility inside the cabinet.



Back Side Air Compensation
To avoid turbulence in work area

ADVANTAGE

1. UV lamp for sterilization.
2. Motorized front glass window.
3. Resistant to weak acid and alkali.
4. Adjustable air speed: 9 levels.
5. Alarm when filter working time 3500 hours.
6. With memory function in case of power-failure.
7. Back side air compensation, to avoid turbulence in work area.
8. 8°slope front ergonomics design, fatigue-free working posture.
9. Microprocessor control system, LED display shows filter working time.
10. Transparent side glass windows maximize light and visibility inside the cabinet, providing a bright and open working environment.

TECHNICAL PARAMETERS

Model	FH1000(X)	FH1200(X)	FH1500(X)	FH1800(X)
External Size (W*D*H)	1000*840*2150mm	1200*840*2150mm	1500*840*2150mm	1800*840*2150mm
Internal Size (W*D*H)	880*730*745mm	1080*730*745mm	1380*730*745mm	1680*730*745mm
Max Opening	520mm			
Work Surface Height	750mm			
Blower	Built-in centrifugal blower; Speed adjustable with 9 levels			
Air Velocity	0.3~0.8m/s			
System Exhaust Volume	630m ³ /h	780m ³ /h	990m ³ /h	1210m ³ /h
Noise	≤68dB			
LED Lamp	8W*1	12W*1	16W*1	16W*1
UV Lamp	20W		30W	
	Emission of 253.7 nanometers for most efficient decontamination			
Front Window	Motorized; 5 mm toughened glass, anti-UV Exterior Body: Cold-rolled steel with anti-bacteria powder coating.			
Material	Work table: Chemical resistant phenolic resin			
Waterproof Socket	1 pc	2 pcs	2 pcs	2 pcs
Power Supply	AC220V±10%, 50/60Hz; 110V±10%, 60Hz			
Consumption	400W	400W	500W	500W
Standard Accessories	Water tap, Gas tap, Water sink, Base stand, UV lamp*2, LED lamp, Socket, 4.3 meters exhaust duct, Active carbon filter, Foot switch			
Optional Accessory	HEPA Filter			
Gross Weight	230kg	253kg	290kg	340kg
Package Size(W*D*H)	1150*1120*1680mm	1350*1120*1680mm	1650*1120*1680mm	1950*1120*1680mm

Ductless Fume Hood



ADVANTAGE

1. LCD Touch screen control panel, easy to operate.
2. With memory function in case of power-failure
3. 8°slope front ergonomics design, fatigue-free working posture.
4. Temperature and humidity sensors, can detect indoor temperature and humidity.
5. Three side transparent Acrylic windows, front window reversal design, easy to operate.
6. Double-layers structure: 1mm sheet metal surface; Chemical resistant phenolic resin work table.
7. Electronic control system, anti-overload, anti-electric shock, stable performance, long service life.
8. Inside and outside probe, detect indoor air pollution and filter conditions. Audible and visual alarm for changing filter.

TECHNICAL PARAMETERS

Model	FH1000(C)	FH1200(C)	FH1500(C)	FH1800(C)	
External Size (W*D*H)	1000*830*2140mm	1200*830*2140mm	1500*940*2140mm	1800*940*2140mm	
Internal Size (W*D*H)	910*690*740mm	1110*690*740mm	1410*690*740mm	1710*690*740mm	
Work Surface Height	900mm				
Max. Opening	650mm				
Air Velocity	0.4~0.6m/s				
Airflow Volume	136m³/h		432m³/h	547m³/h	
Noise	≤58dB(A)				
Fluorescent Lamp	14W*2		14W*3		
UV Lamp (Optional)	Emission of 253.7 nanometers for most efficient decontamination				
Blower	Built-in centrifugal blower, speed adjustable				
Front Window	Acrylic window; Manual; reversal design				
Power Supply	AC220V±10%, 50/60Hz; 110V±10%, 60Hz				
Consumption	400W		500W		
Material	Exterior	Cold-rolled steel with anti-bacteria powder coating			
	Side Window	Acrylic Window			
	Work Table	Chemical resistant phenolic resin			
Chemical Filter	2 pcs		4 pcs		
Standard Accessory	Fluorescent Lamp, Base cabinet Total load of 2 waterproof sockets: 500W; Chemical Filter				
Optional Accessory	Water tap, Gas tap, Water sink, Electric height adjustable base stand, HEPA Filter, UV Lamp				
Gross Weight	290kg	310kg	380kg	410kg	
Package Size	Main Body	1140*1040*1490mm	1350*1040*1490mm	1650*1110*1490mm	1950*1110*1490mm
	Base Cabinet	1140*1040*1060mm	1350*1040*1060mm	1650*1110*1060mm	1950*1110*1060mm

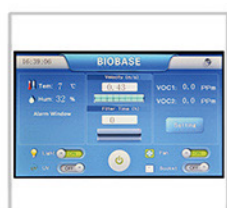

LCD Display
LCD Touch Screen
Control Panel



**Waterproof
Socket**



**Water & Gas tap
reserve mouth**



Front Window
Front window reversal
design



**Explosion-proof
Fluorescent Lamp**



Walk-in Fume Hood



Water Sink



Water & Gas Remote Control Valve



Water & Gas Tap



Application



Application

ADVANTAGE

1. With memory function in case of power-failure.
2. Operators are available to walk into the fume hood to operate if need.
3. Large room exhaust system, suitable for large laboratory instruments and equipment.

TECHNICAL PARAMETERS

Model	FH1200(W)	FH1500(W)	FH1800(W)	
External Size (W*D*H)	1200*800*2250mm	1500*800*2250mm	1800*800*2250mm	
Internal Size (W*D*H)	980*550*1670mm	1280*550*1670mm	1580*550*1670mm	
Max Opening	1300mm			
Exhaust Airflow Volume	1150m ³ /h	1500m ³ /h	1850m ³ /h	
Inflow Air Velocity	0.3~0.8m/s			
Noise	≤ 62dB			
Vibration	Amplitude ≤5μm			
Illumination	≥800Lux			
LED Lamp	12W*2	16W*2	16W*2	
Power Supply	AC220V±10%, 50/60Hz; 110V±10%, 60Hz			
Consumption	400W	500W	800W	
Front Window	Manual, 5mm toughened glass,height adjustable			
Material	Exterior	1.0mm cold-rolled steel with bacteria powder coating.		
	Interior	Compact laminate board with good acid and alkali resistance function		
Standard Accessory	External blower , LED lamp, Water tap, Gas tap, PP cup sink, Remote control water valve, Remote control gas valve, Waterproof sockets*4, 4.3 meters Φ300mm PVC exhaust duct			
Sockets	Total load of 4 waterproof sockets: ≤500W			
Package Size (W*D*H)	Main Body	1400*1050*2450mm	1710*1050*2450mm	2010*1050*2450mm
	Exhaust Blower	970*810*720mm	1040*890*710mm	1040*890*710mm
Gross Wight	300KG	340KG	390KG	

Mobile Fume Extractor



INTRODUCTION

The mobile fume extractor is an air purification equipment which can provide the partial high pure environment. The airflow is vertical laminar flow type. It is widely used in medical research laboratories, precision instrument, bio-pharmacy, micro-organism studies and etc.

FEATURES

1. Freely moving, easy to operate and install.
2. The purification system consists of fan, primary efficient filter, high efficient filter and activated carbon filter.
3. HEPA filter ensures the filtering efficiency to 99.999% efficiency at 0.3 μ m.

TECHNICAL PARAMETERS

Model	MFE-I
External Size(W*D*H)	500*500*980mm
Air Velocity	0.3~0.5m/s
Filter Efficiency	99.995% efficiency at 0.3 μ m
Noise	≤75dB(A)
Suction Inlet Diameter	375mm
Rated Power	180W
Power Supply	AC110V/220V±10%, 50Hz/ 60Hz;
Gross Weight	76kg(15kg for Extracting arm;61kg for Purification system)
Net Weight	67kg
Package Size(W*D*H)	810*510*600mm(Extracting arm) 630*630*1175mm(Purification system)

FFU (Fan Filter Unit)



FEATURES

1. FFU shell and HEPA filter adopt split design, easy to install and replace.
2. Microprocessor control system, energy-saving and low noise.
3. Long service-life blower, up to 100,000 hours, maintenance-free and small vibration.
4. Suitable for using separately or connecting together for assembly line.
5. Made of aluminium coated zinc plate, anti-corrosion, rust-proof and light weight.

TECHNICAL PARAMETERS

Model	FFU 1000	FFU 1200	FFU 1500	FFU 1800
External Size(W*D*H)	975*575*380mm	1175*575*380 mm	1475*575*380 mm	1775*575*380 mm
Air Velocity	0.45 m/s±20%			
HEPA Filter	99.999% efficiency at 0.3 μ m			
HEPA Filter Size(W*D*H)	970*69*570mm	1170*69*570mm	1470*69*570mm	1770*69*570mm
Blower	Built-in centrifugal blower			
Noise	≤60dB			
Consumption	110W		220W	
Power Supply	AC220V±10%, 50/60Hz; 110V±10%, 50/60Hz			
Shell Material	Aluminium coated zinc plate			
Gross Weight	60kg	70 kg	90kg	110kg
Package Size(W*D*H)	1135*540*800mm	1335*540*800mm	1635*540*800mm	1935*540*800mm



Clean Booth (Down Flow Booth)



Customization Available



Reference Picture

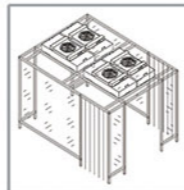

Design Drawing



Microprocessor Control
Users can control the fan, light, UV and adjust the air velocity with it.



FFU(Fan Filter Unit), which draws in contaminated air from the top of the module, and exhausts filtered clean air vertically in a unidirectional (laminar) air stream at its base, is a self-contained fan and filter module for clean room applications.



Soft Wall Material
PVC anti-static dustproof curtain.

INTRODUCTION

Clean booth is a kind of air purifying equipment providing partial high clean environment, It's the easiest and fastest way to build a simple clean room. Equipped with a lot of clean level and space collocation, it can be designed as request. Main characteristics: simple use, good flexibility, easy installation, short construction time, and movable. It can be installed in part of clean room of general level which requires high cleanliness to save cost.

FEATURES

1. Customized design is welcomed.
2. It can be used singly or combined.
3. Compared with civil type and fabricated type clean room of hundred clean level, it has low running cost and fast effect and can be easily installed.
4. Modular construction, easy to increase clean level, good expansion and reusable, convenient movement (Universal wheel can be installed).

TECHNICAL PARAMETERS

Model	BKCB-1500	BKCB-2000	BKCB-3000	BKCB-5000
External Size (W*D*H)	2000*1500*2530mm	3000*2000*2530mm	4000*3000*2530mm	5000*5000*2530mm
Internal Size (W*D*H)	1920*1380*2140mm	2920*1880*2115mm	3880*2880*2095mm	4880*4880*2095mm
HEPA Filter	99.995% efficiency at 0.3µm			
Consumption	800W	1500W	2800W	5000W
FFU Nos.	4pcs	6pcs	12pcs	25pcs
Clean Level	ISO 5(Class100),Class A			
Control System	Microprocessor control system			
Rectangular Tube Material	Aluminium alloy			
Wall Material	Anti-static dustproof curtain			
Blower	Built-in centrifugal blower,speed adjustable			
UV Lamp	40W	40W*2	40W*3	40W*5
	Emission of 253.7 nanometers with UV timer			
Illumination Lamp	16W*1	16W*2	16W*3	16W*5
	LED Lamp,Illumination:≥500lux			
Air Velocity	0.1~0.6m/s,average 0.45m/s			
Noise	≤75dB			
Power Supply	AC220V±10%, 60Hz/50Hz;110V±10%, 60Hz			
Gross Weight	390kg	670kg	1100kg	2900kg
Net Weight	355kg	625kg	1020kg	2800kg
Package Size(W*D*H)	2110*930*920mm	3080*980*1280mm	3080*980*1280mm*2	4080*980*1280mm*3
	2280*660*500mm	3080*660*550mm	4080*660*550mm	1260*660*1280mm 5080*460*500mm
Customized design for clean level, size or material is available				



Dispensing Booth (Sampling or Weighing Booth)



Customization Available



Reference Picture

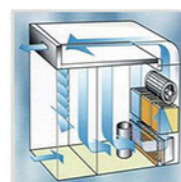

Air Flow Pattern



Differential Pressure Gauge
Dwyer make Magnehelic gauges are used to measure the pressure drop HEPA filter 0-500 Pa.



LCD Display
Microprocessor control system

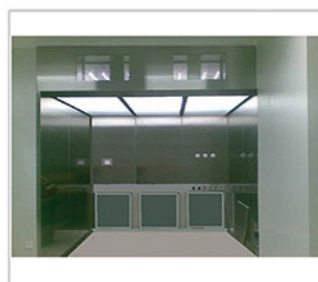

Reference Picture

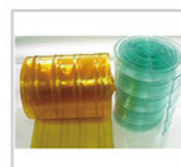

Soft Wall Material
PVC anti-static dustproof curtain.

INTRODUCTION

Dispensing booth is a kind of partial purifying equipment for filling, refilling, weighing and sampling of raw material and compounds. It is provided with HEPA filter, which prevents the airborne dusts by down draught technique. The unit eliminates powder contamination to protect the operator and the surrounding environment.

Dispensing booth is also called sampling booth or weighing booth.

FEATURES

1. Customized design is welcome.
2. Unique designed air duct effectively controls the noise.
3. Smooth transitions of wall and ground can eliminate the blind angle.
4. Differential pressure gauge is equipped to real-time monitor the filters.
5. Intelligent control mode and alarm system ensure the reliability of running.
6. Automatic changeable frequency system monitors the air velocity to ensure its stability in the work area.
7. Uniform flow design of main working area can protect the operators and prevent environmental pollution and cross contamination of products.
8. Dispensing Booth(Sampling or Weighing Booth) has primary filters, medium efficiency filters and HEPA filters to keep air cleanliness of work area.

TECHNICAL PARAMETERS

Model	BKDB-1200	BKDB-1800	BKDB-2400
Clean Level	ISO 5 (Class 100), Class A		
HEPA Filters	99.995% efficiency at 0.3μm		
Air volume	Supply air volume: ≤7500m ³ /h, Exhaust air volume: ≤2250m ³ /h; Adjustable		
Material	Fully stainless steel		
Air Velocity	0.3~0.6m/s, adjustable		
Pressure Gauge	3 pcs		
Noise	≤75dB		
UV Lamp	30W*1	40W*1	30W*2
	Emission of 253.7 nanometers, with UV timer		
Illuminating Lamp	14W*4	16W*4	16W*4 & 14W*2
	LED Lamp, Illumination: ≥500lux		
Power Supply	AC220V±10%, 50/60Hz; 110V±10%, 60Hz		
Consumption	600W	1000W	1700W
Sockets	2 pcs		
Work Area Size(W*D*H)	1200*1200*2000mm	1800*1800*2000mm	2400*1800*2000mm
External Size(W*D*H)	1300*1700*2400mm	1900*2300*2400mm	2500*2400*2400mm
Gross Weight	420kg	750kg	840kg
Package Size(W*D*H)	1440*2540*1980mm	2020*760*2420mm	2640*960*2380mm
		2020*660*495mm	2640*780*680mm
		1950*530*2160mm	2640*560*2250mm

Customized design for clean level, size or material is available



Pathology Workstation



Configuration

UV Light;
Fluorescent Light;
Adjustable Spotlight;
Stainless Steel Hanger;
"UV, FAN, LIGHT,
PULVERIZER" Control.



Water Tap & Sink

Stainless steel;
Whole-structure.



Suction Inlet

Suction inlet adopts louver-type.
The upper mouth structure
ensures above blower suction,
avoiding air back-streaming.



Flex Magnifier Light(Optional)

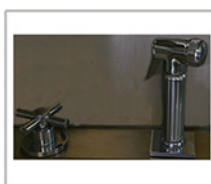

Auto Flushing Design

Automatic flushing device, slightly
right-side slope worktable, easy to
waste discharge and cleaning.



Pulverizer (Optional)

Completely smash the waste
during test, to avoid blocking
drainage pipes.

APPLICATION

Pathological sampling bench is widely used in hospital pathology department, pathology laboratory, etc. Reasonable ventilation system protects operator away from the harmful gas produced by the formalin during sampling. The hot & cold water system ensures it can adapt work in different climates.

ADVANTAGE

1. Odor-remove function.
2. Single water sink, two-person operations.
3. Exhaust air system: High-power suction device, low noise.
4. Optional water heater is available, realizing hot & cold water adjustment.
5. The base cabinet is inward-concave type, convenient for sitting operation.
6. Optional pulverizer can completely smash the waste during test, to avoid blocking drainage pipes.
7. Automatic flushing device, slightly right-side inclined worktable, easy for waste discharge and cleaning.

TECHNICAL PARAMETERS

Model	QCT-1000	QCT-1500	QCT-1800
External Size(W*D*H)	1000*750*1950mm	1500*750*1950mm	1800*750*1950mm
Working Area Size(W*D)	895*430mm	1395*430mm	1695*430mm
Work Surface Height	850mm		
Consumption	300W	300W	300W
Power Supply	AC220V±10%, 50/60Hz; 110V±10%, 60Hz		
Exhaust Airflow Volume	500~600m³/h		
Material	Main Body	304 stainless steel	
	Work Table	304 stainless steel	
Standard Accessories	Spotlight; UV lamp; Fluorescent lamp; Exhaust system; 4m exhaust duct; Pipe strap		
	Auto flushing device; Stainless steel hanger; Adjustable hot and cold water tap; 180mm deep stainless steel water sink, funnel with filter. Active carbon filter		
Optional Accessories	Pulverizer, Electrical water heater, Automatic induction hand dryer, Eye washer, Camera, Flex magnifier light, laptop bracket		
Package Size(W*D*H)	1160*890*2170mm	1660*890*2170mm	1960*890*2170mm
Gross Weight	250kg	300kg	340kg

Chicken Isolator



LED Display
Temperature and humidity, with fan, UV lamp, fluorescent lamp, heating lamp control buttons.



Footmaster Caster
Universal caster with brake and leveling feet, easy to move and fix



Depressurization Type Water Tank
With automatic feed water system, labor saving

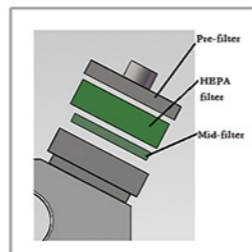

Filters Pattern

INTRODUCTION

Chicken isolator is Positive pressure isolator.
BCI-I Chicken Isolator is designed for SPF chicken feeding and poultry disease testing.

ADVANTAGE

1. Automatic water supply system, adjustable height drinking tank.
2. Special sealing design, ensure good sealing performance.
3. Manipulation of the chicken can be realized via gloves from both sides.
4. Adopt full 304 stainless steel material, high quality accessories, such as Butyl gloves, HEPA filter etc.
5. Filtration system, can protect animals, environment and operator.
Pre-filter→ main HEPA filter→Filter cotton.
6. Three sterilization ways available.
 - ① UV lamp for sterilization.
 - ② Reserved hole for hot steam sterilization.
 - ③ Reserved hole for disinfectant spraying sterilization.
7. Unique defecation system & fecal leakage shelf. Animal wastes drop from shelf to bottom fecal collection film, then pull of collecting film and clean out wastes conveniently and quickly, reduce the cleaning frequency.
8. The inner wall of the glove mouth is equipped with a sliding sealing plate, which can seal the glove mouth when there is no operation.
9. The heating lamp adopts high temperature resistant lamp holder, and has protective cover to prevent chickens from touching, safe and reliable.

TECHNICAL PARAMETERS

Model	BCI-I
External Size (W*D*H)	2200*850*1800mm
Animal Activity Area(W*D*H)	1600*750*820mm
Waste Collection Area(W*D*H)	1600*750*250mm
Display	LED display:temperature,humidity adjustable(10-50°C), with fluorescent lamp, UV lamp,heating lamp ,fan button
Air Change Rate	≥20 times/h
Airflow Velocity	0.1m/s~0.2m/s within the chicken living space
Falling Bacteria (numbers/utensil/hour)	0
Filter	Pre-filter, Mid-filter, HEPA (H14) filter
Noise	≤70dB(A)
Alarm	High and low temperature alarm
Caster	Universal caster with brake and leveling feet
Rated Power Supply	AC220V±10%, 50/60Hz; 110V±10%, 60Hz
Rated Consumption	700W
Gross Weight	180kg
Package Size (W*D*H)	2430*1010*2070mm
Standard Accessories	Pre-filter*2, HEPA filter*2, Mid-filter*2, UV lamp, heating lamp*2, high quality butyl gloves*6(pairs), feeding and drinking system



Air Purifier

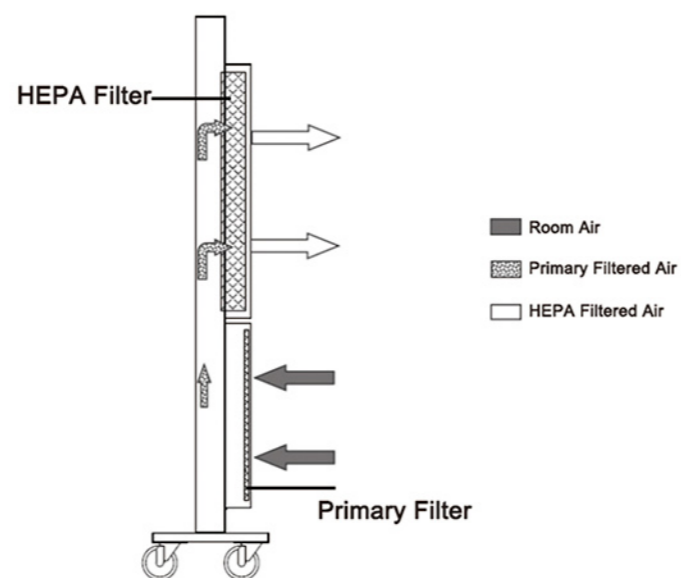
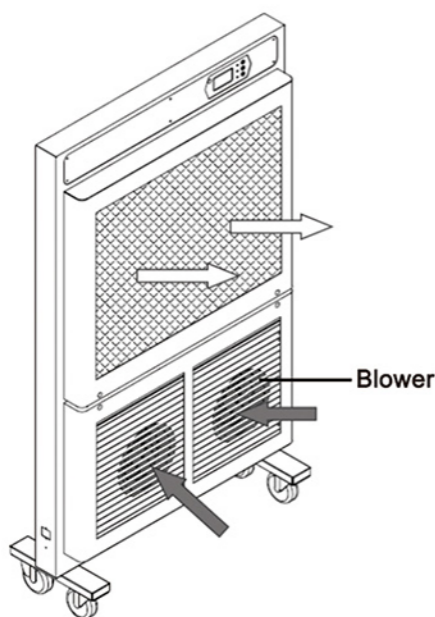

FEATURES

Air purifier is an air purification equipment, which is widely used in hospital, small clinic, laboratory, office, meeting room and house etc. it can protect your life and your health through filtering dust, germ and virus in the air.

ADVANTAGE

1. Low noise.
2. LCD display
3. Remote control.
4. Adjustable air velocity.
5. Thorough sterilizing with UV Lamp.
6. Mobile Type, Wall Hanging Type, Suction Ceiling Type.

TECHNICAL PARAMETERS

Model	QRJ-128
External Size(W*D*H)	900*120*1500mm
Filter	Primary Filter, HEPA filter
HEPA Filter	99.99% efficiency at 0.3µm
UV Lamp	Germicidal UV lamp, Emission of 253.7 nanometers for most efficient decontamination
Optimal Space	≤20m ²
Noise	≤58dB
Consumption	240W
Adjustable Air Speed	3 levels
Power Supply	AC220V±10%, 50/60Hz; 110V±10%, 60Hz
Cleanness At Outlet	Class 100
Gross Weight	78kg
Package Size(W*D*H)	1800*440*1050mm

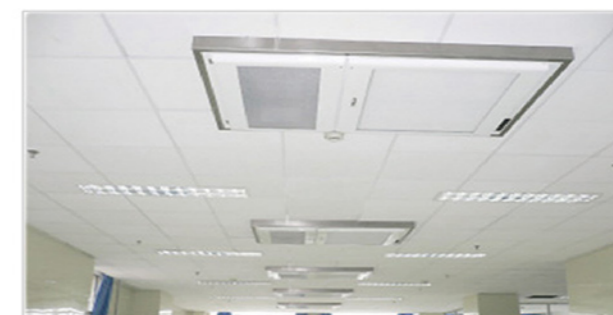

Air Shower



Air shower is a necessary passage for people entering clean room in order to minimize the amount of particulate contaminant, to achieve workplace strict clean purification standards. Personnel move through the air shower while particulate contaminants are blown off by the clean high-speed air. Then the dust cannot be brought into clean area.

Features

1. Photoelectric sensor, automatic blowing.
2. Adopt with circulation wind to ensure the cleanness of shower area under non-shower status.
3. Double doors by electric interlock.
4. LED display with adjustable blowing time (0~99s).
5. HEPA Filter, Class 100 cleanness.

Model	AS-1P1S	AS-1P2S	AS-2P2S
External Size(W*D*H)	1300*1000*2050mm	1500*1000*2050mm	1500*2000*2050mm
Internal Size(W*D*H)	800*900*1930mm	800*900*1930mm	800*1900*1930mm
HEPA Filter	99.995% efficiency at 0.3µm		
Spraying Wind Speed	25m/s		
Air Shower Time	0~99s(adjustable)		
No.of SS Nozzles	6	12	24
Fluorescent Lamp	12W*1	12W*1	12W*1
Consumption	550W	1100W	2200W
Cabinet Material (Optional)	1. Full cold-rolled steel with powder coating. 2. Internal stainless steel, external with cold-rolled steel. 3. Full stainless steel.		
Door Material (Optional)	1.Cold-rolled steel with powder coating. 2. Stainless steel.		
Chassis	Stainless steel		
Power Supply	AC220V±10%, 50/60Hz; 110V±10%, 60Hz		
Gross Weight	300kg	400kg	700kg
Package Size(W*D*H)	1400*1200*2200mm	1600*1200*2200mm	1600*2200*2200mm

Pass Box



Pass Box

Air Shower Box

Pass Box is used to transfer goods between rooms of different clean levels of clean room. It can reduce times of opening door, prevent the air convection between different rooms and minimize the pollution extent.

Type	Air Shower Pass Box			Pass Box		
Model	ASPB-01	ASPB-02	ASPB-03	PB-01	PB-02	PB-03
External Size(W*D*H)mm	660*570*1000	760*670*1100	860*770*1200	660*570*580	760*670*680	860*770*780
Internal Size(W*D*H)mm	500*500*500	600*600*600	700*700*700	500*500*500	600*600*600	700*700*700
Material	304Stainless steel					
Interlock	Electrical					
UV Lamp	15W*1			8W*1		
HEPA Filter	Efficiency≥99.995% at 0.3um			/		
Clean Air Speed	0.36~0.54m/s			/		
Power Supply	220V, 50Hz; 110V, 50/60Hz					
Gross Weight (Kg)	80	100	120	55	70	90
Packing Size(W*D*H) mm	780*700*1250	880*800*1350	980*900*1450	780*700*770	880*800*870	980*900*970

Animal Cage Changing Station



Air Flow Pattern Diagram:

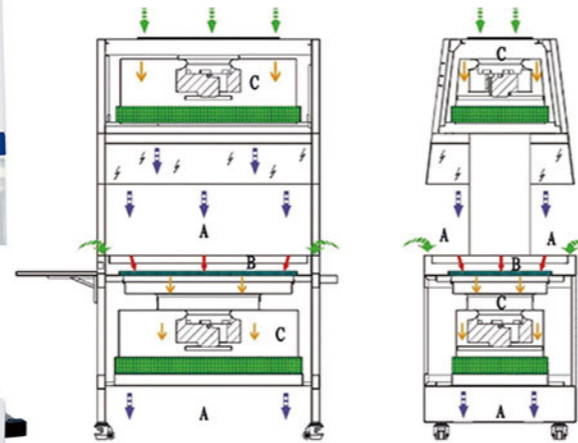

- Primary Efficiency Filter
- ULPA Filter
- Room Air
- Polluted Air
- Semi-Purified Air
- Purified Air
- A Protected Area
- B Polluted Air
- C Semi-Polluted Air

Details:

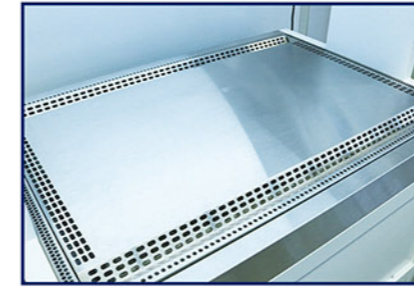

V-type air grille:

V-type air grid collects ambient air and combines with vertical laminar downflow to produce an air curtain to protect operators from harmful substances.



Stainless steel tray:

The left side of the workstation is equipped with a stainless steel tray for easy placement of experimental supplies.



Easy to move:

The Fuma caster design and the right side handle design, easy to move the cabinet.



Highlight LCD touch screen design:

Real-time dynamic display of the downflow velocity and inflow velocity, the overall operating time, the temperature and humidity, and the resistance of the air supply and exhaust filters.

INTRODUCTION

The animal cage changing station is suitable for the replacement of animal cages in SPF animal rooms, the anatomy of experimental animals and the separation of tissues, etc. It adopts positive vertical flow, double primary effect and double high efficiency filtration design, which can prevent animals in the work area from being polluted by outside air. Protect the operator from allergens and special odors generated during the experiment. In addition, the double-sided open design facilitates simultaneous operation by multiple person. It is a safety protection device specially designed for animal research laboratories.

FEATURES

1. Two-way safety protection: with excellent ventilation system and negative pressure airflow, it can provide two-way safety protection for people, animals, environment, and objects during the process of animal cage change.
2. Use high-quality materials: the work surface is made of 304 stainless steel, which can be quickly disassembled and cleaned up waste.
3. Double-layer filtration system: primary and high-efficiency double-layer filtration system.
4. Control system: LCD touch screen design, real-time dynamic display of the airflow speed of the workstation.
5. Audio and visual alarm: Abnormal air flow velocity and Filter replacement .

TECHNICAL PARAMETERS





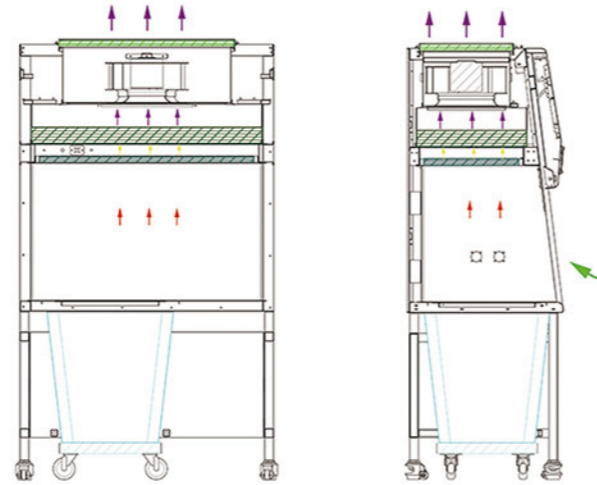

Model	DAW-1100
Power Supply	AC220V±10%, 50/60Hz (Standard); AC110V, 60Hz (Optional)
Instrument Size(L*D*H)	1580*750*1980mm
Operating Area Size(L*D*H)	1015*750*585mm
Laminar Airflow Velocity	≥0.35m/s
Noise	≤65dB (A)
Illuminance	≥1000lx
LED Lamp	12W*2
Consumption(W)	800W
Air Supply ULPA Filter Size	925*470*69mm
Exhaust ULPA Filter Size	910*480*69mm
Primary Filter Size	890*505*25mm
Filtration Efficiency	99.9995%(φ0.12μm)
Number of Users	1-2
Package Size (L*D*H)	1460*890*2270mm
Gross Weight	243kg

Animal Litter Workstation



Air Flow Pattern Diagram:



-  Activated Carbon Filter
-  ULPA Filter
-  Primary Efficiency Filter
-  Room Air
-  Polluted Air
-  Semi-Purified Air
-  Purified Air

APPLICATION

It is suitable for the treatment of animal litter in the SPF animal room, to prevent the pollutants generated when dumping the animal litter from harming the experimenters and the working environment, and to provide safety protection for the experimenters and the working environment.

FEATURES

1. Use high-quality materials: the three side walls of the working area adopt high-quality 304 stainless steel integrated structure, and the internal cleanable parts adopt rounded corner design, leaving no dead corners and easy to clean.
2. Strong tolerance: the working area has a large opening, which can accommodate all common animal cages.
3. Control system: Control system: LCD touch screen design, real-time display of working status, easy to operate.
4. Ergonomic design: help reduce fatigue, improve work efficiency, and provide a safer working environment.

Details:



Dual sensors:
The working area is equipped with temperature and humidity sensors and airflow sensors, real-time monitoring of temperature, humidity and airflow changes in the working area.



Large-capacity storage bucket:
The large-capacity storage bucket is equipped with a lid and a mobile trolley, which is convenient for transportation.

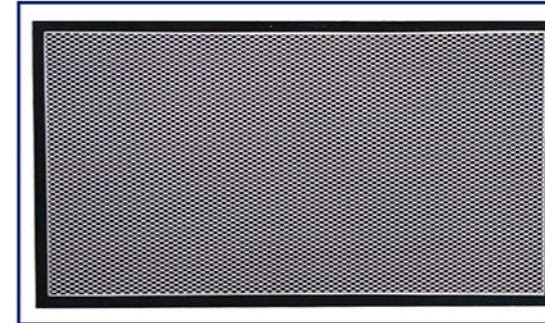

Activated carbon filter:
Add an activated carbon filter to the air outlet to absorb gaseous pollutants and reduce odor.

LCD touch screen:

Display the working time of the high-efficiency filter; realize the appointment timing of the fan and socket; display the working status in real time.

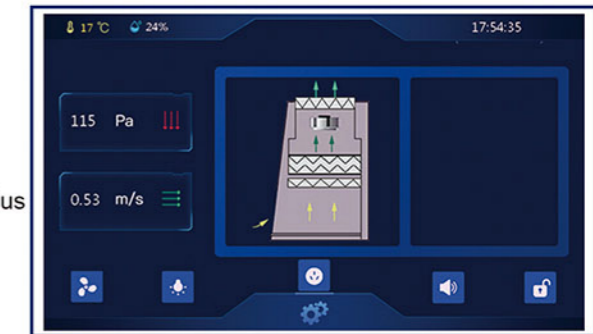

TECHNICAL PARAMETERS

Model	DDW-1100
Power Supply	AC220V, 50Hz(Standard); AC110V, 60Hz(Optional)
Instrument Size(L*D*H)	1100*700*1920mm
Operating Area Size(L*D*H)	1000*600*660mm
Laminar Airflow Velocity	≥0.35m/s
Noise	≤65dB (A)
Illuminance	≥1000lx
LED Lamp	12W*2
Consumption(W)	700W
Primary Filter Size	967*453*30mm*1
High Efficiency Filter Size	1000*485*69mm*1
Activated Carbon Filter Size	758*408*35mm*1
Filtration Efficiency	99.9995%(φ0.12μm)
Ambient Temperature	15°C~35°C
Relative Humidity	≤75%
Atmospheric Pressure Range	70 kPa~106 kPa
Package Size (L*D*H)	1250*850*2100mm
Gross Weight	240kg

Mini PCR Workstation



INTRODUCTIONS

The Mini PCR Workstation is the world's exclusive nucleic acid detection workstation, specially developed for fever clinics and small clinical laboratories. Integrate traditional PCR laboratory functions into one device. Allow more small laboratories to have PCR detection capabilities.

APPLICATION

It is suitable for rapid nucleic acid detection in the fever clinic and emergency department of hospital, other small clinical laboratories.

FEATURES

1. Global exclusive
2. Small dimension, save space, economical and convenient.
3. Automatic air speed adjustable with filter block.
4. With memory function in case of power-failure.
5. Interlock function: UV lamp and front window; UV lamp and blower, florescent lamp; Blower and front window.
6. Audio and visual alarm: Filter replacement, window over height, abnormal air flow velocity etc.
7. Time reserve function: This can set the UV lamp and fan working time.



LCD Display

1. Large Digital LCD display is easy to monitor.
2. All the safety parameters at a glance and ergonomically sized control panel improves User interface.

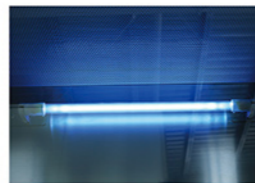

UV Lamp

1. Emission of 253.7 nanometers for most.
2. Efficient decontamination.



Work Zone

Work zone is made of 304 stainless steel, Unibody design.



Front Window

Toughened glass >5mm, anti UV.



Waterproof Socket

2 waterproof sockets are located in the each area, for optimum convenience of using small devices inside the cabinet.



Windproof Plate

Effectively isolate the cross-effects of airflow in various areas.

Reagent Preparation Area Specimen Preparation Area Amplification Analysis Area

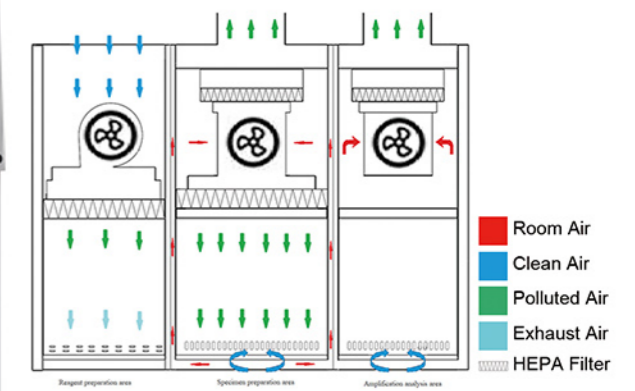

Reagent Preparation Area:

Positive pressure, vertical laminar flow design, equipped with primary filter and HEPA filter, which can protect the reagent preparation from external pollution and protect the reagent.

Specimen Preparation Area:

Negative pressure; the air inlet is through the front window glass door, the bottom of the operation area is returned to the air, and the top is exhausted; the upper and lower two HEPA filters are equipped to protect personnel from harmful aerosol infection and protect samples from external pollution.

Amplification Analysis Area:

Negative pressure, the air inlet is through the front window glass door, the bottom of the operation area is returned to the air, and the top is exhausted, and the HEPA filter can protect both the personnel and the environment.

Mini PCR Workstation

TECHNICAL PARAMETERS

Model	PCR1600	PCR2100	PCR2500	
External Size(L*W*H)	1600*710*1900mm	2100*710*2000mm	2500*850*2100mm	
Reagent Preparation Area	Operating Area Size (L*W*H)	440*560*510mm	640*560*510mm	640*560*610mm
	Pressure	Positive		
	Airflow Velocity (m/s)	0.3~0.45		
	Airflow Volume (m³/h)	190~290	290~430	380~560
	Exhaust Type	/		
Specimen Preparation Area	Operating Area Size (L*W*H)	560*560*510mm	660*560*510mm	1060*560*610mm
	Pressure	Negative		
	Airflow Velocity (m/s)	Downflow: 0.33±0.025, Inflow: 0.53±0.025		
	Airflow Volume (m³/h)	210	250	400
	Exhaust Type	TypeA2, 30% exhaust, 70% recirculation		
Amplification Analysis Area	Operating Area Size (L*W*H)	440*560*510mm	640*560*510mm	640*560*610mm
	Pressure	Negative		
	Airflow Velocity (m/s)	≥0.4		
	Airflow Volume (m³/h)	≥160	≥180	≥180
	Exhaust Type	30% exhaust, 70% recirculation	100% exhaust	100% exhaust
ULPA Filter	Four, 99.999% efficiency at 0.12µm.			
Clean Level	Class 100(ISO Class 5)	Class 100, Except Amplification Analysis Area		
Front Window	Manual, Toughened glass, Anti UV			
Max Opening	400mm	480mm		
Noise	≤67 dB (A)			
Vibration	≤5µm			
UV Lamp	15W*3, UV timer, UV life indicator	30W*1, 15W*2		
LED Lamp	4W*6	8W*6	8W*4, 12W*2	
Illumination(lx)	≥500 (Each area)	≥650 (Each area)		
Sockets	The load of two sockets (Each area): 500W, total 6 sockets			
Display	Touch Screen			
Control System	Microprocessor			

Model	PCR1600	PCR2100	PCR2500
Visual and Audio Alarm	Filter replacement, window over height, abnormal air flow velocity		
Work Surface Height	750 mm		
Material	Work Zone: 304 stainless steel		
	Main Body: Cold-rolled steel with anti-bacteria powder coating		
Power Supply	AC220V±10%, 50/60Hz; 110V±10%, 60Hz		
Consumption	600W, total 2100W (With load)		1000W, total 2500W
Standard Accessory	LED lamp*6, UV lamp*4, Windproof plate*2 (Only for PCR2100/2500), Waterproof sockets*6		
Package Size(W*D*H)	1750*980*1400mm	2250*980*1400mm	2650*1120*1400mm
Gross Weight	400kg	450kg	500kg

MINI PCR WORKSTATION EQUIPMENT LIST:

Item	Name	Model	Quantity
Reagent preparation area	Pipette	0.5-10ul	1
	Pipette	10-100ul	1
	Pipette	100-1000ul	1
	Centrifuge	MINI-7	1
	Mixer	BJPX-VW	1
	Tips	10ul,100ul, 1000ul	/
	Centrifuge tube	1.5ml	/
	8-strip tube	0.2ml	/
	QPCR kit	Covid-19	/
	Specimen preparation area	Pipette	0.5-10ul
Pipette		10-100ul	1
Pipette		100-1000ul	1
Disposable Virus Sampling Collector (One Step method)		/	/
Tips		10ul,100ul, 1000ul	/
Centrifuge tube		1.5ml	/
Centrifuge		MINI-7	1
Mixer		BJPX-VW	1
Nucleic Acid Extraction System (only for PCR2500)		BNP32 or BNP8	1
Amplification analysis area		QPCR	LEIA-X4
Other related equipment	Biosafety Transport Box	BTB-L5	1
	-25°C Freezer	BDF-25V270	1
	-86°C Freezer	BDF-86V158	1